



US00D663147S

(12) **United States Design Patent**
Cheng

(10) **Patent No.:** **US D663,147 S**
(45) **Date of Patent:** **** Jul. 10, 2012**

(54) **BLIND WITH HONEYCOMB STRUCTURE**

(76) Inventor: **Li-Ming Cheng**, Kaohsiung (TW)

(**) Term: **14 Years**

(21) Appl. No.: **29/380,865**

(22) Filed: **Dec. 13, 2010**

(51) **LOC (9) Cl.** **06-10**

(52) **U.S. Cl.** **D6/575**

(58) **Field of Classification Search** D6/575,
D6/576, 577, 579, 580, 581; 160/84.01,
160/84.3, 84.04, 84.05, 84.06, 121.1, 167,
160/170, 171, 279, 329, 368; 296/95, 97,
296/141; D12/318; 242/157, 384.7; 24/141,
24/142; 156/197; 428/116

See application file for complete search history.

(56) **References Cited**

U.S. PATENT DOCUMENTS

4,849,039 A * 7/1989 Colson et al. 156/197
5,832,979 A 11/1998 Marusak
D493,650 S * 8/2004 Tuzmen D6/575
6,814,128 B2 11/2004 Nien
D501,749 S * 2/2005 Gruner D6/575

D515,345 S * 2/2006 Herhold et al. D6/575
7,811,651 B2 * 10/2010 Yu 428/116
D636,204 S * 4/2011 Elinson et al. D6/575

* cited by examiner

Primary Examiner — Susan Bennett Hattan

Assistant Examiner — Barbara B Lohr

(74) *Attorney, Agent, or Firm* — Alan Kamrath; Kamrath IP
Lawfirm, PA

(57) **CLAIM**

I claim the ornamental design for blind with honeycomb
structure, as shown in the accompanying drawings.

DESCRIPTION

FIG. 1 is a perspective view of a blind with honeycomb
structure showing my new design;

FIG. 2 is a left side elevational view thereof;

FIG. 3 is a right side elevational view thereof;

FIG. 4 is a top plan view thereof;

FIG. 5 is a bottom plan view thereof;

FIG. 6 is a front elevational view thereof;

FIG. 7 is a rear elevational view thereof;

FIG. 8 is a perspective view thereof in application to a hon-
eycomb blind, wherein environmental structures illustrated
by broken lines form no part of the claimed design.

FIG. 9 is a perspective view thereof in a folded situation; and,

FIG. 10 is a perspective view of the honeycomb blind thereof
in a folded situation, wherein environmental structures illus-
trated by broken lines form no part of the claimed design.

1 Claim, 7 Drawing Sheets

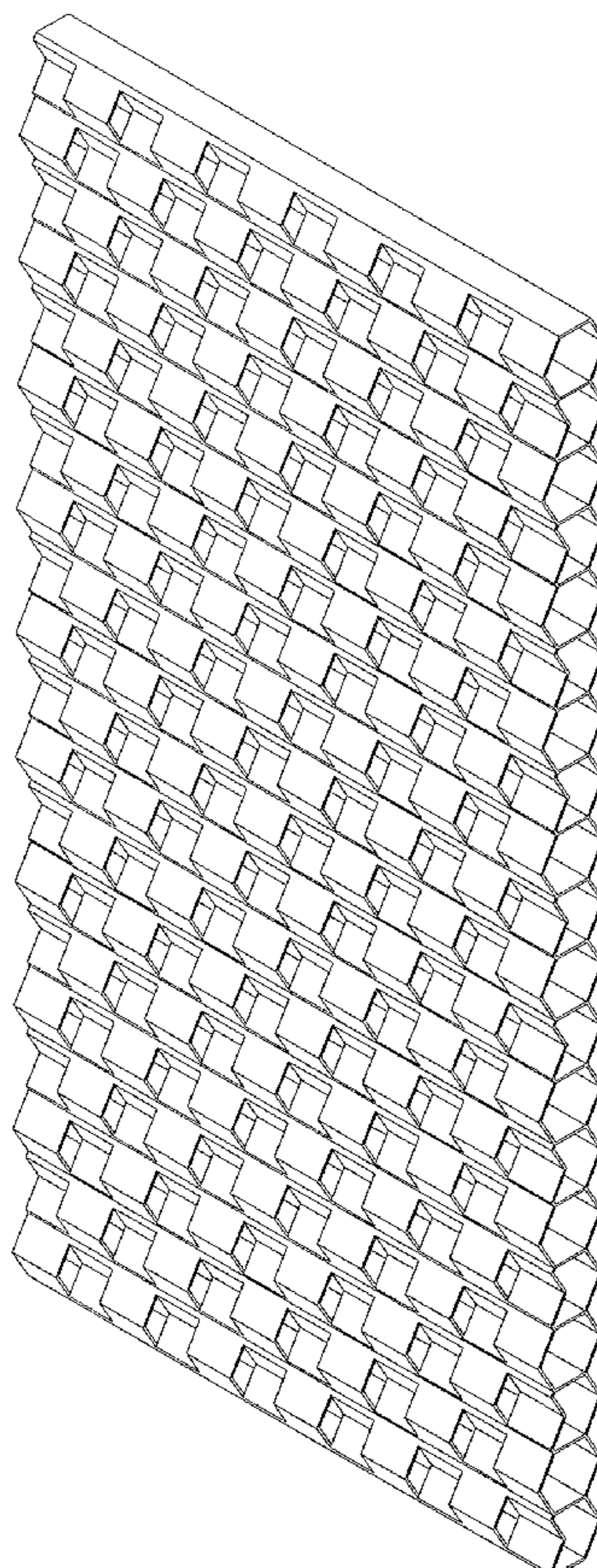

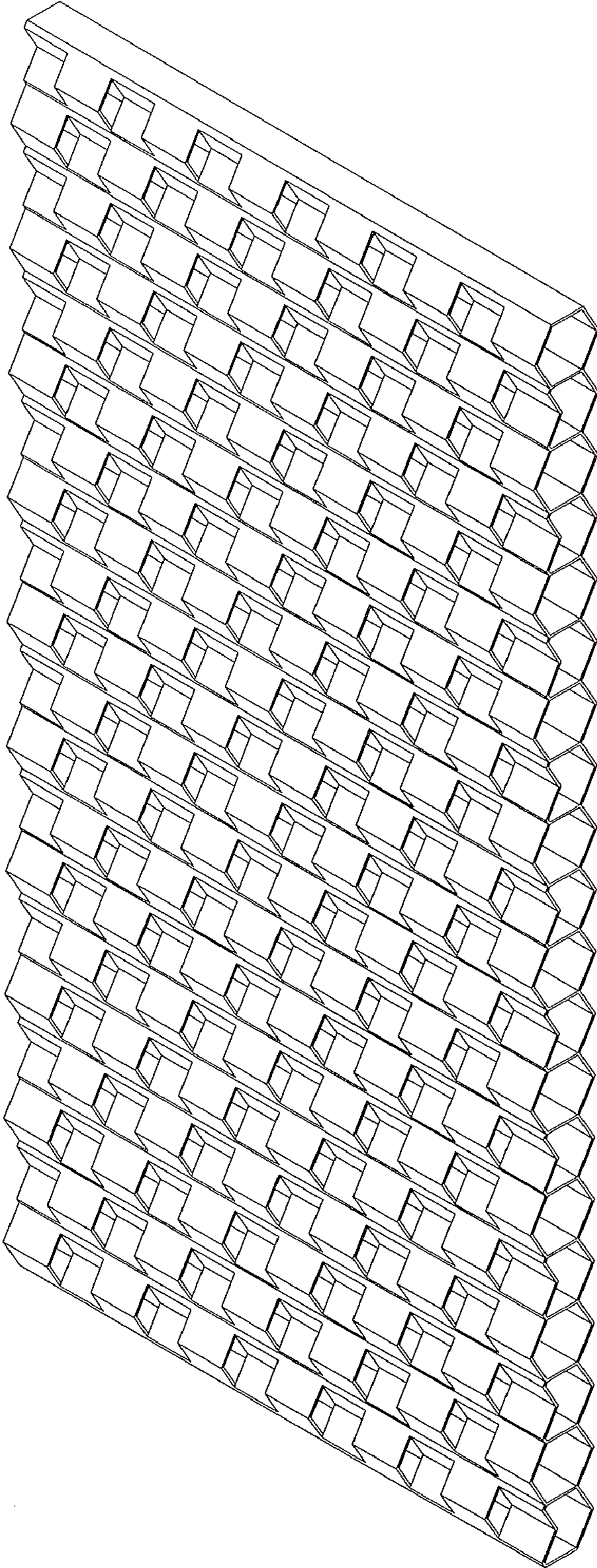

FIG. 1

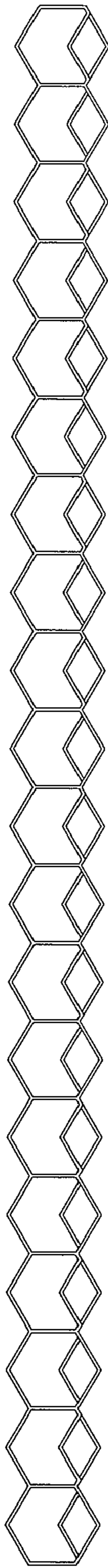

FIG. 2

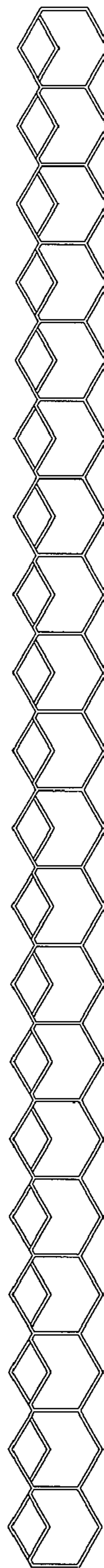

FIG. 3

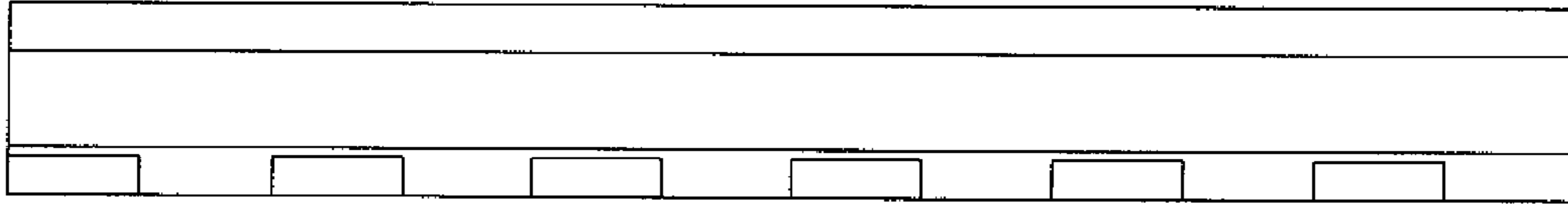

FIG. 4

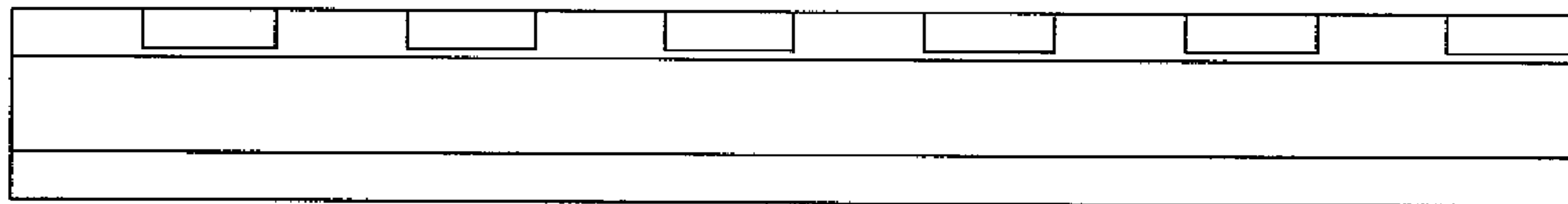

FIG. 5

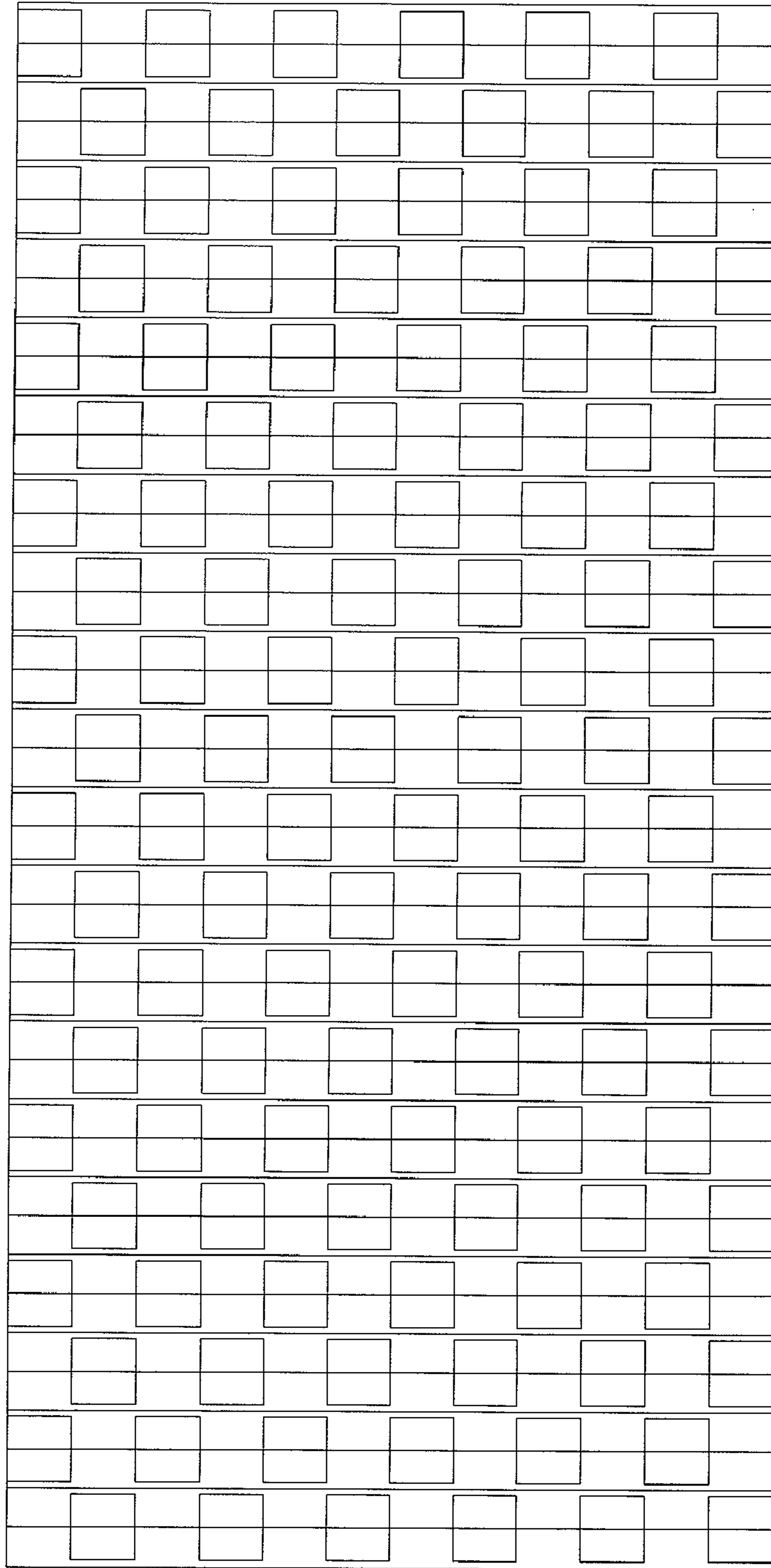

FIG. 6

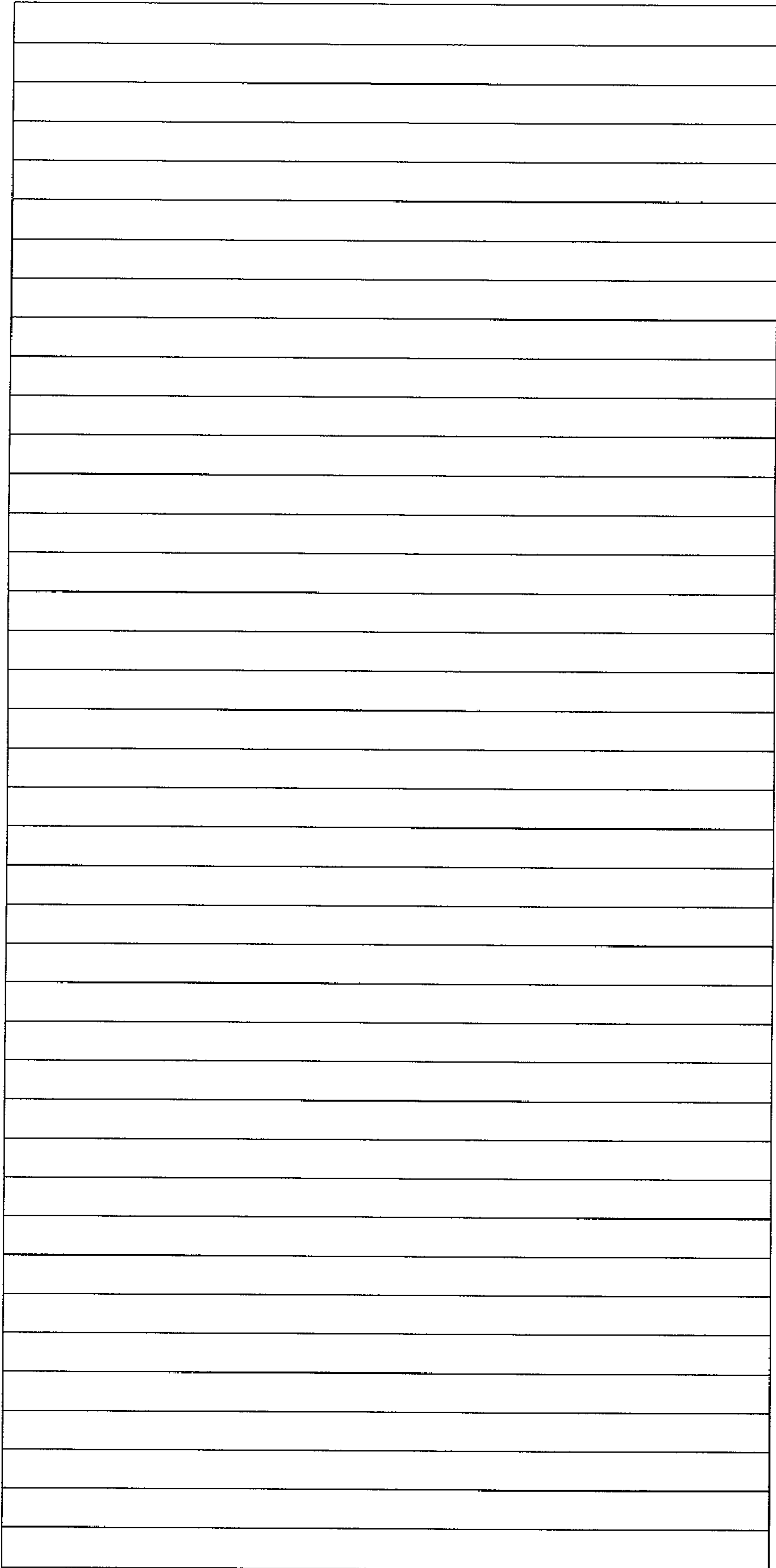

FIG. 7

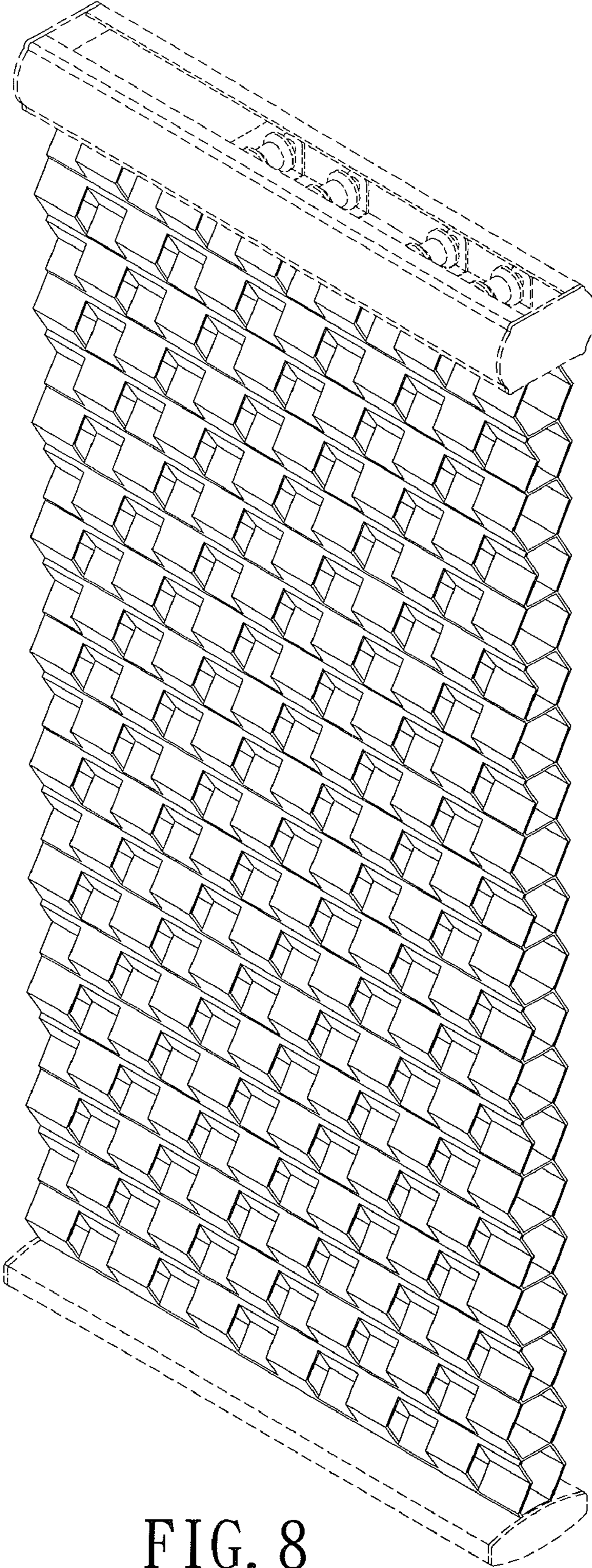

FIG. 8

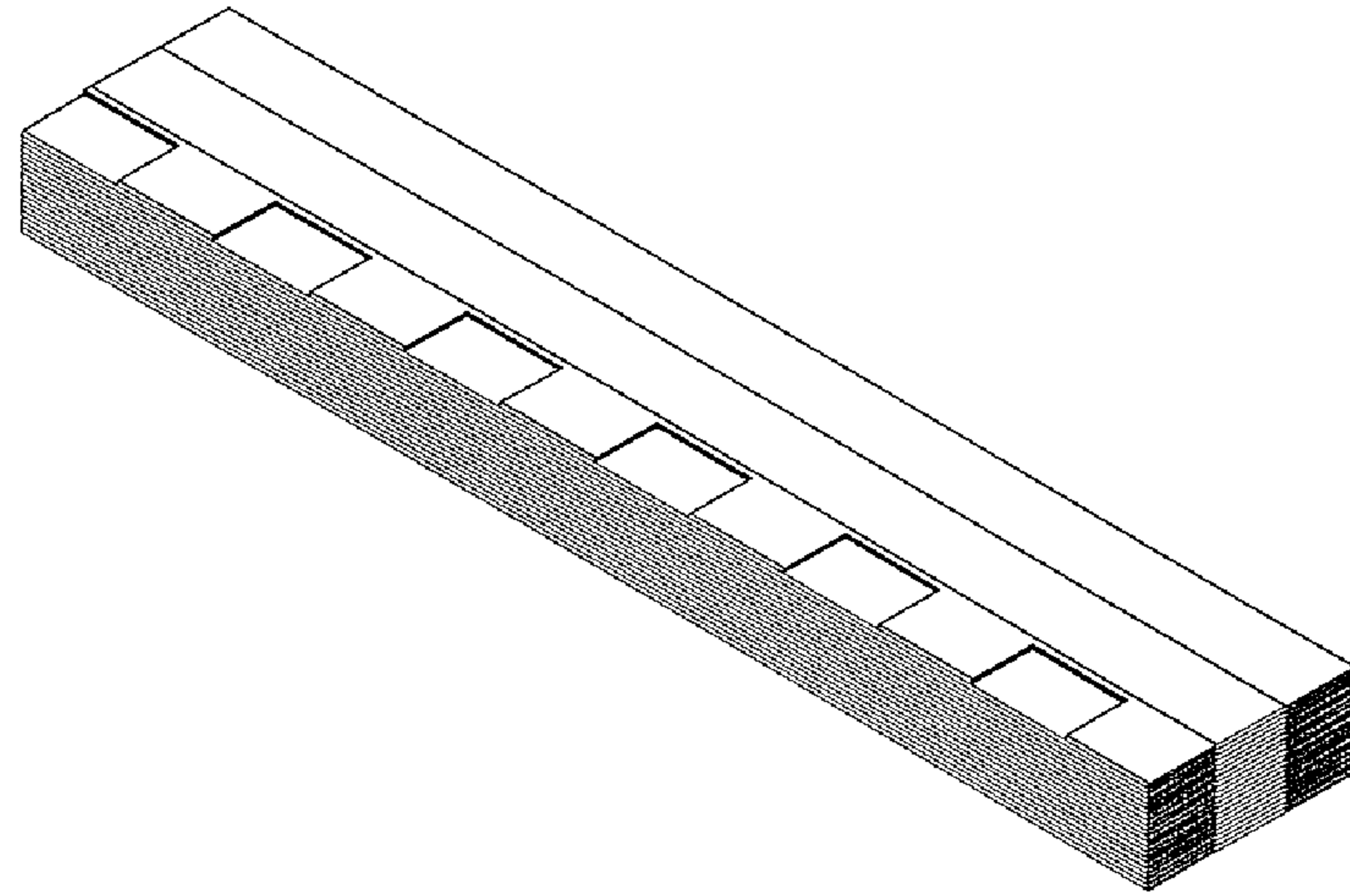

FIG. 9

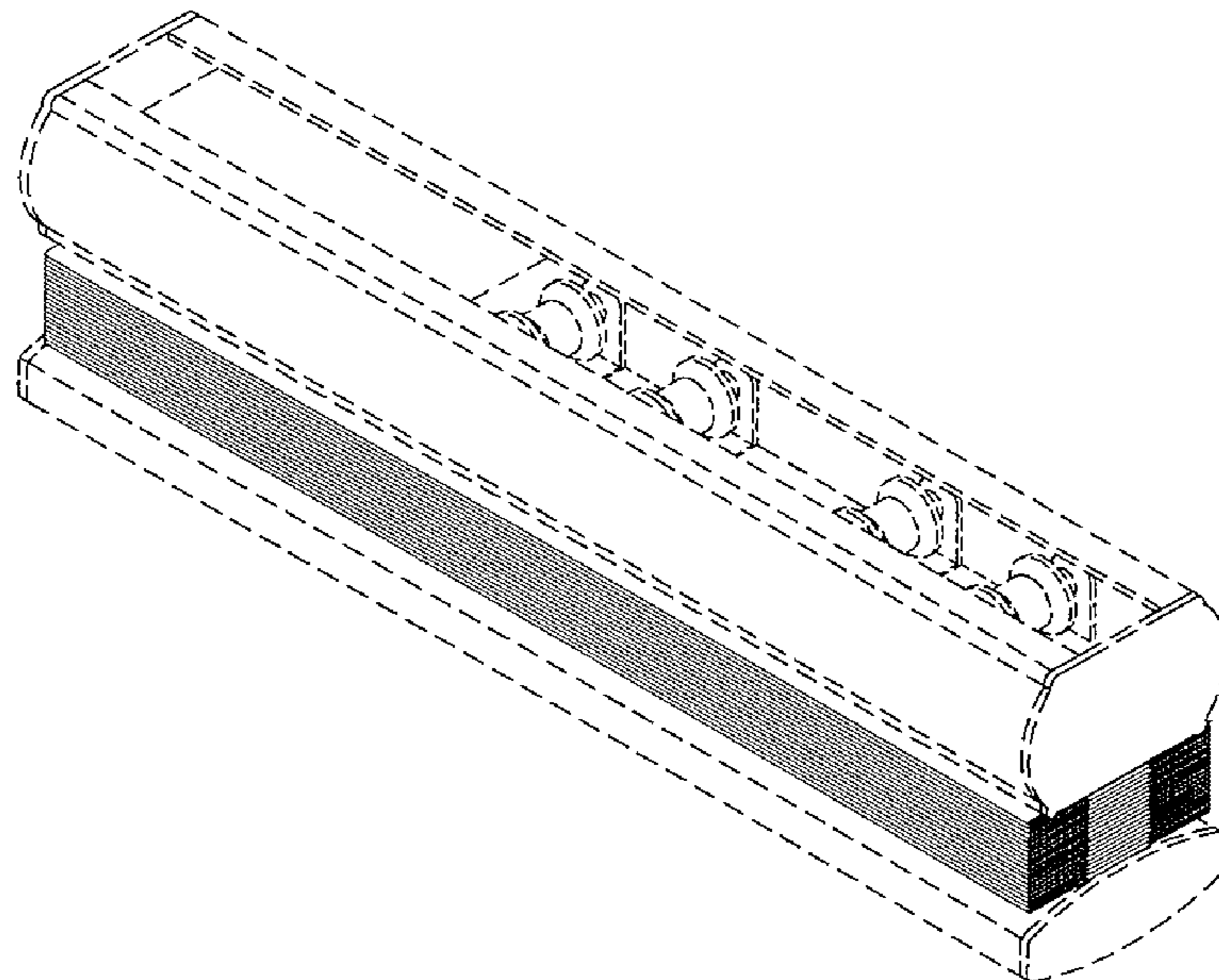

FIG. 10