



US00D663065S

(12) **United States Design Patent**
Beghelli

(10) **Patent No.:** **US D663,065 S**

(45) **Date of Patent:** **** Jul. 3, 2012**

(54) **LIGHTING APPARATUS**

(75) Inventor: **Gian Pietro Beghelli**, Monteveglio (IT)

(73) Assignee: **Beghelli S.p.A.**, Monteveglio (Bologna)
(IT)

(**) Term: **14 Years**

(21) Appl. No.: **29/376,908**

(22) Filed: **Oct. 13, 2010**

(30) **Foreign Application Priority Data**

Apr. 14, 2010 (EM) 00169563-0003

(51) **LOC (9) Cl.** **26-03**

(52) **U.S. Cl.** **D26/76**

(58) **Field of Classification Search** D26/75-85,
D26/88, 89, 72, 25, 3, 113, 118, 128, 141,
D26/142, 51; 362/555, 14, 148, 150, 217.01,
362/217.05, 217.06, 217.07, 217.08, 217.09,
362/217.1, 217.12, 217.13, 260, 296.01,
362/404, 101

See application file for complete search history.

(56) **References Cited**

U.S. PATENT DOCUMENTS

D123,768 S * 12/1940 Scribner D26/78
D378,860 S * 4/1997 Galletly D26/77
D440,340 S * 4/2001 Tillman et al. D26/76
D476,753 S * 7/2003 Chelf et al. D26/3
D496,122 S * 9/2004 Kan D26/76
D521,675 S * 5/2006 Chen D26/76
D547,897 S * 7/2007 Willmorth et al. D26/76
D592,349 S * 5/2009 Maxik et al. D26/76

D597,701 S * 8/2009 Tran et al. D26/76
D607,598 S * 1/2010 Xiao et al. D26/80
D617,935 S * 6/2010 Miletich et al. D26/76
2005/0041419 A1 * 2/2005 Kazi et al. 362/219
2007/0183148 A1 * 8/2007 Mayfield et al. 362/223

* cited by examiner

Primary Examiner — Angela J Lee

(74) *Attorney, Agent, or Firm* — Hedman & Costigan, P.C.;
Kathleen A. Costigan

(57) **CLAIM**

I claim the ornamental design for a lighting apparatus, as shown and described.

DESCRIPTION

FIG. 1 is a perspective view of a lighting apparatus according to the present invention;
FIG. 2 is a top view of the lighting apparatus according to the present invention;
FIG. 3 is a bottom view of the lighting apparatus according to the present invention;
FIG. 4 is a left side view of the lighting apparatus according to the present invention;
FIG. 5 is a right side view of the lighting apparatus according to the present invention;
FIG. 6 is a front view of the lighting apparatus according to the present invention; and,
FIG. 7 is a back view of the lighting apparatus according to the present invention.
The portions of the lighting apparatus shown in broken lines form no part of the claimed design.

1 Claim, 3 Drawing Sheets

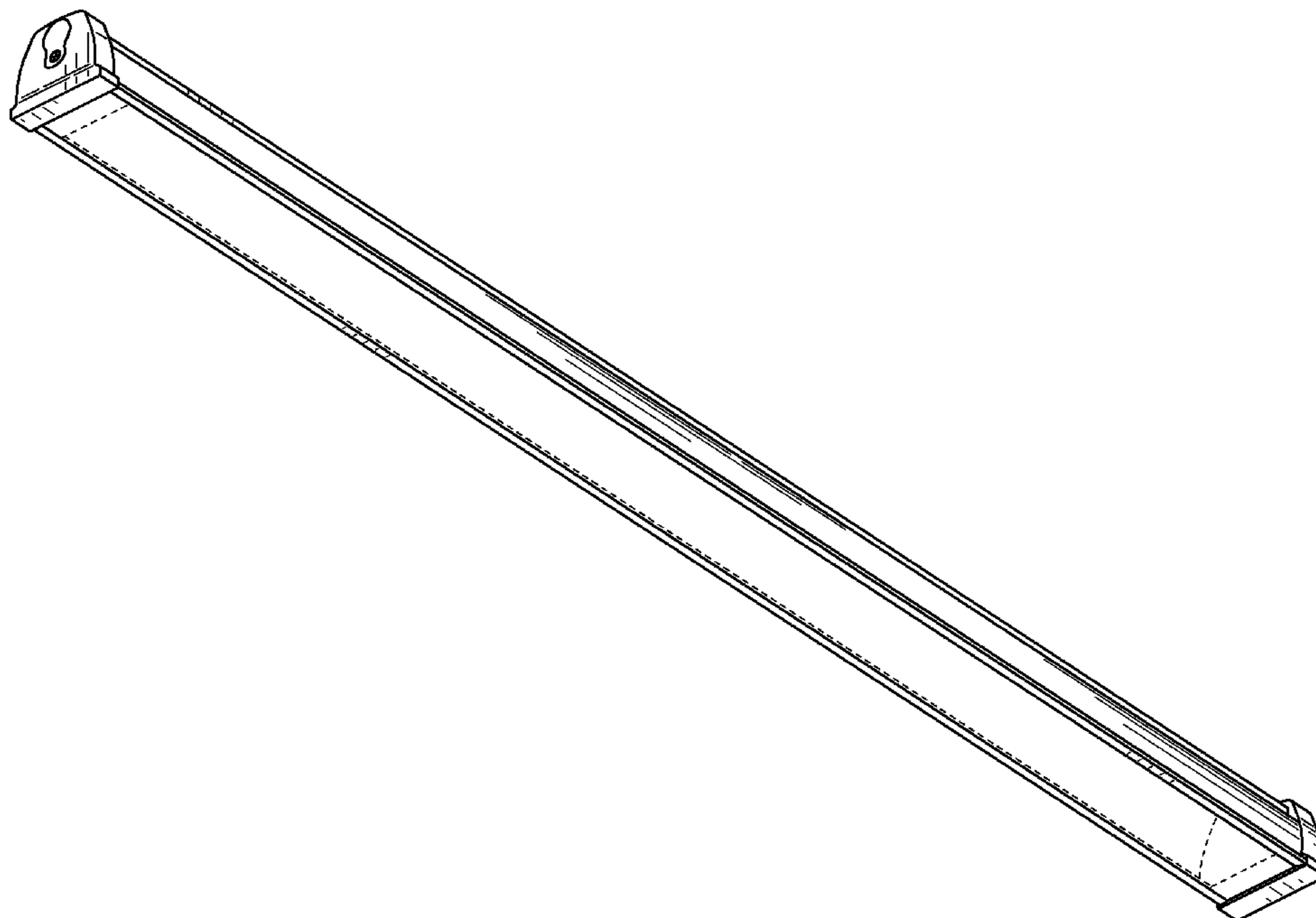

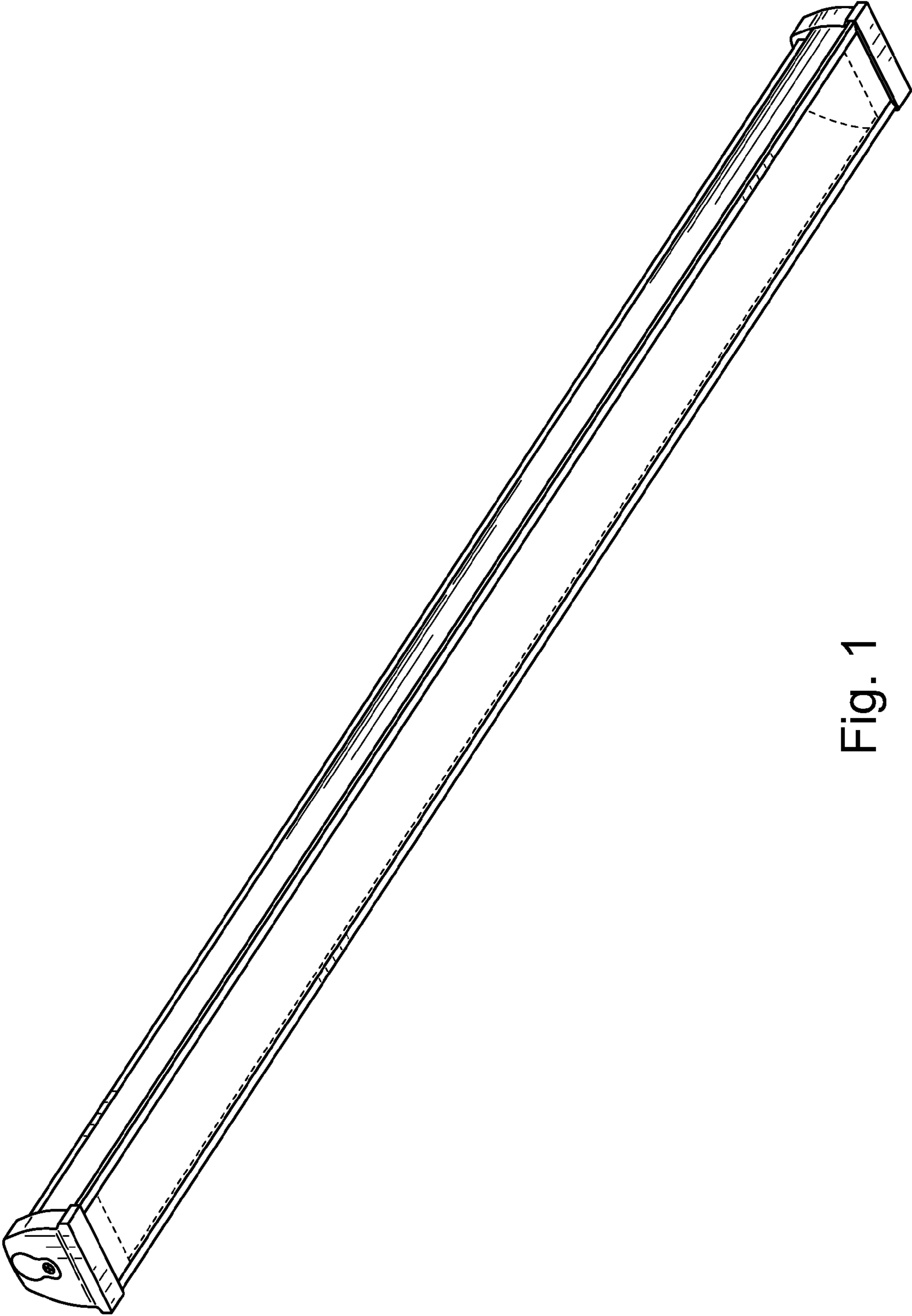

Fig. 1

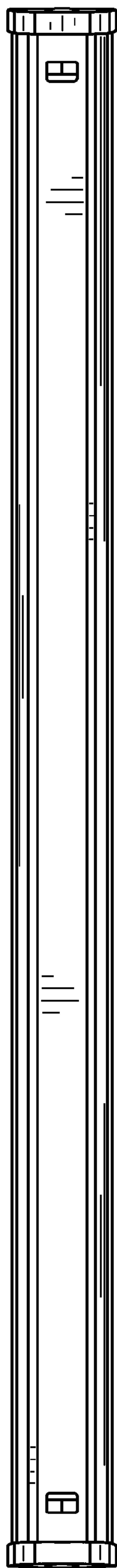

Fig. 2

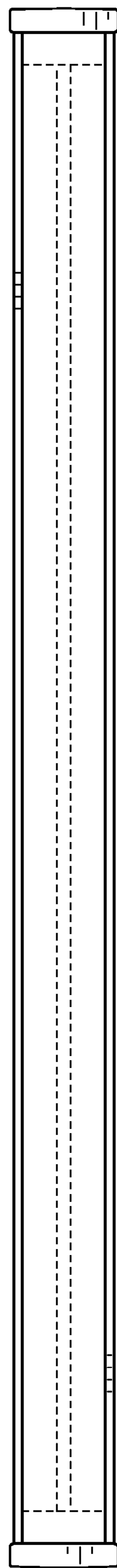

Fig. 3

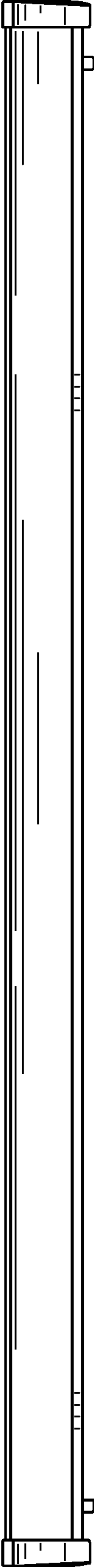

Fig. 4

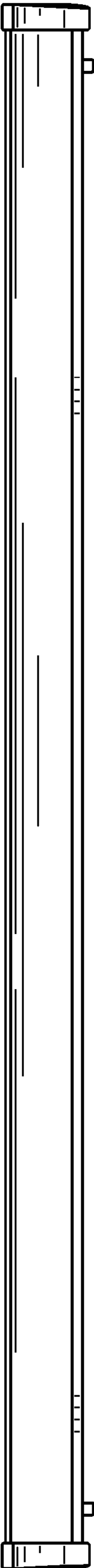

Fig. 5

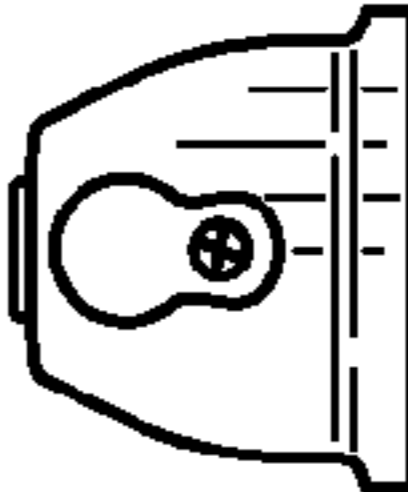

Fig. 6

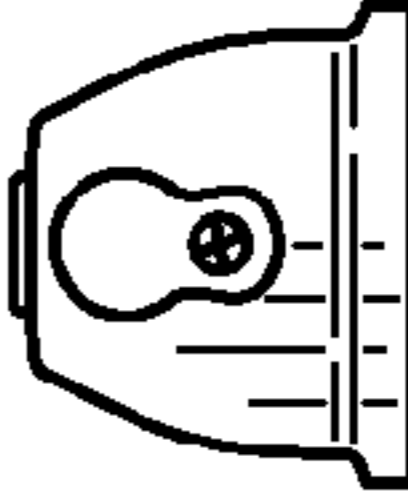

Fig. 7