



US00D663063S

(12) **United States Design Patent**
Yang

(10) **Patent No.:** **US D663,063 S**

(45) **Date of Patent:** **** Jul. 3, 2012**

(54) **DECORATIVE LANTERN**

(76) Inventor: **Jerry S. C. Yang**, Taichung (TW)

(**) Term: **14 Years**

(21) Appl. No.: **29/405,769**

(22) Filed: **Nov. 7, 2011**

(51) **LOC (9) Cl.** **26-05**

(52) **U.S. Cl.** **D26/67**

(58) **Field of Classification Search** D26/67-71,
D26/85, 92; 362/147, 157, 183, 186, 431,
362/432

See application file for complete search history.

(56) **References Cited**

U.S. PATENT DOCUMENTS

D73,930 S	*	11/1927	Lindsay	D26/67
D76,549 S	*	10/1928	Paxson	D26/67
D82,636 S	*	11/1930	Underwood	D26/67
D190,518 S	*	6/1961	Shoemaker	D26/67
D426,013 S	*	5/2000	Landefeld	D26/68
D518,912 S	*	4/2006	Burke	D26/87
D530,035 S	*	10/2006	Wen	D26/67
D534,676 S	*	1/2007	Chen	D26/87
D550,891 S	*	9/2007	Miranda	D26/85
D563,585 S	*	3/2008	Lee et al.	D26/67

D604,440 S	*	11/2009	Chen	D26/67
D646,832 S	*	10/2011	Chen	D26/85
D646,833 S	*	10/2011	Chen	D26/85

* cited by examiner

Primary Examiner — Clare E Heflin

(74) *Attorney, Agent, or Firm* — Pai Patent & Trademark Law Firm; Chao-Chang David Pai

(57) **CLAIM**

The ornamental design for a decorative lantern, as shown and described.

DESCRIPTION

FIG. 1 is a perspective view of a decorative lantern, showing my new design;

FIG. 2 is a front elevational view thereof;

FIG. 3 is a rear elevational view thereof;

FIG. 4 is a left side elevational view thereof;

FIG. 5 is a right side elevational view thereof;

FIG. 6 is a top plan view thereof; and,

FIG. 7 is a bottom plan view thereof.

The broken lines showing the plastic shade and support in FIGS. 1-5 and 7 are included for illustrative purposes and form no part of the claimed design.

1 Claim, 6 Drawing Sheets

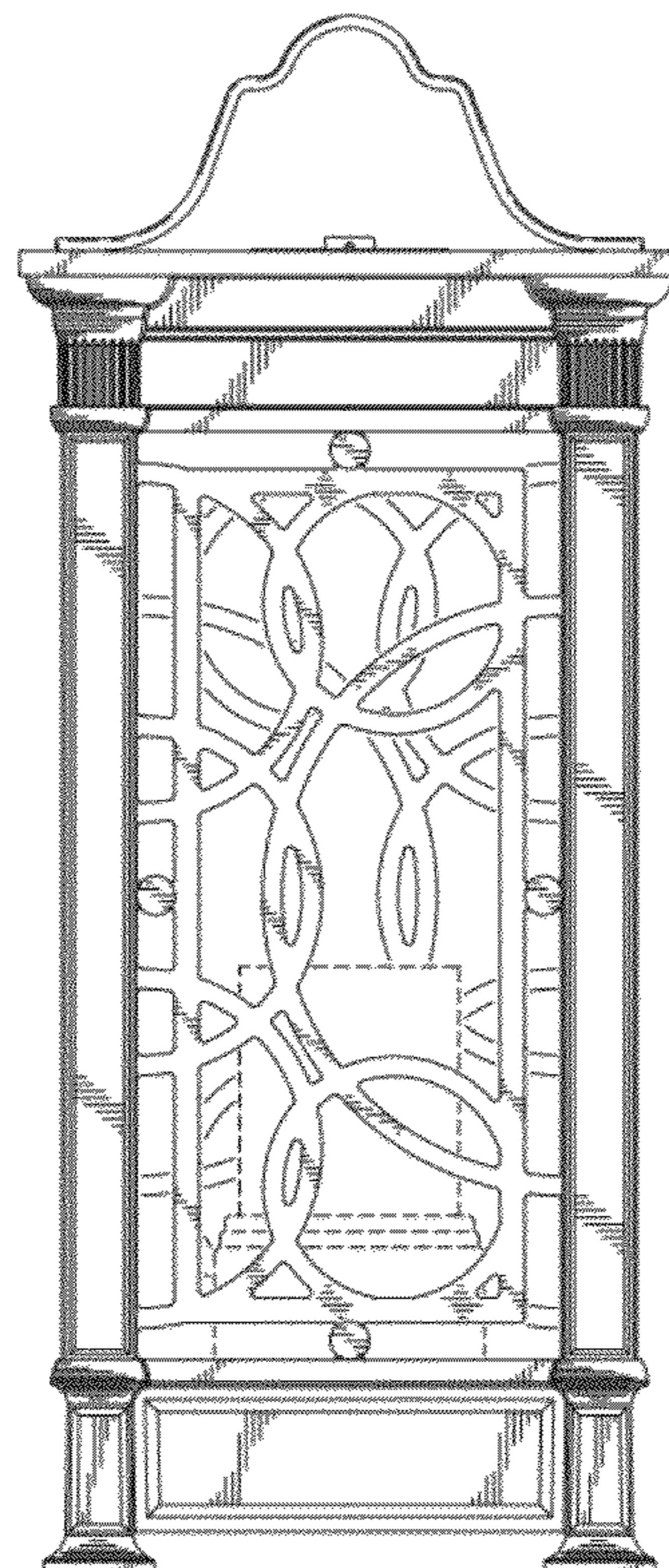
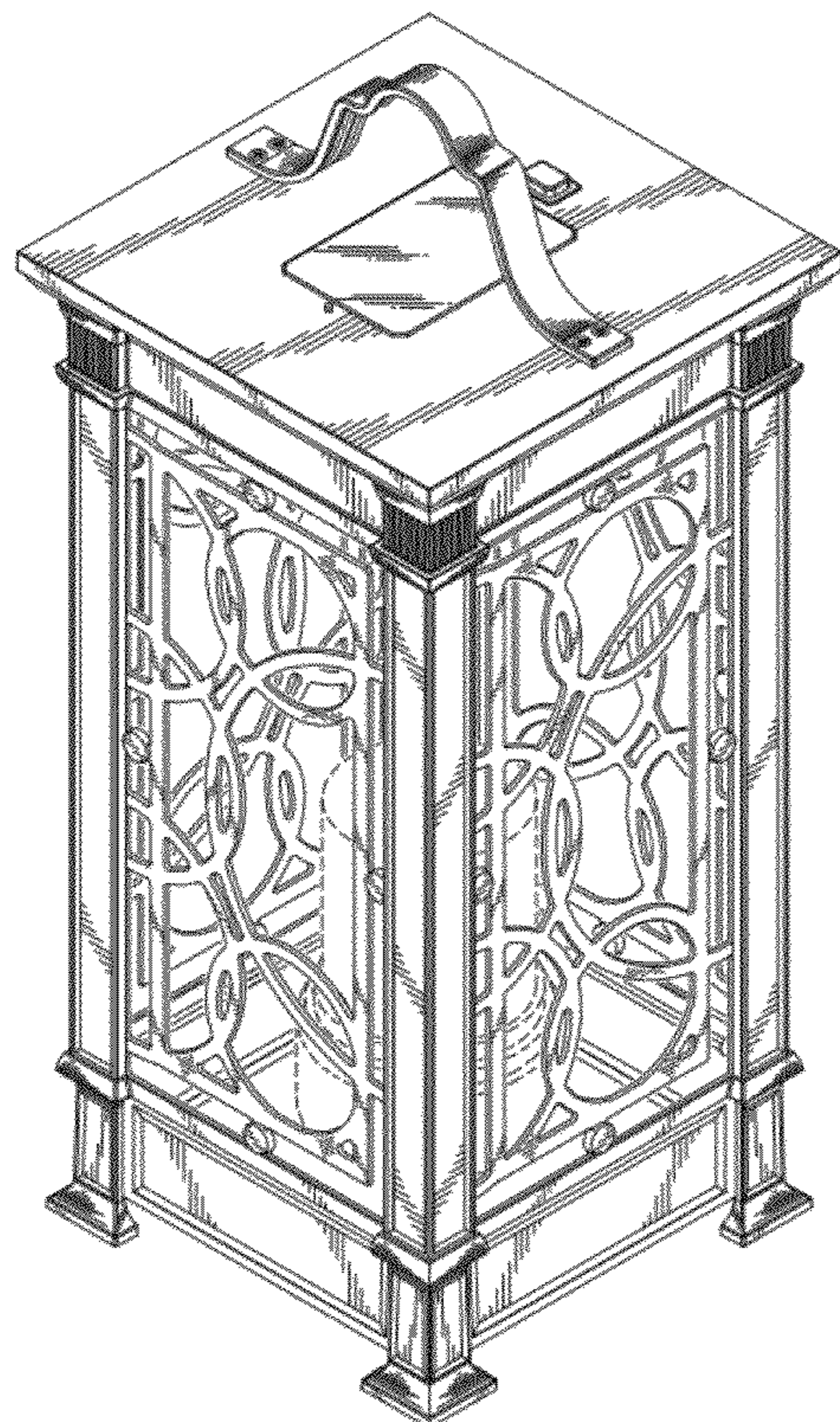

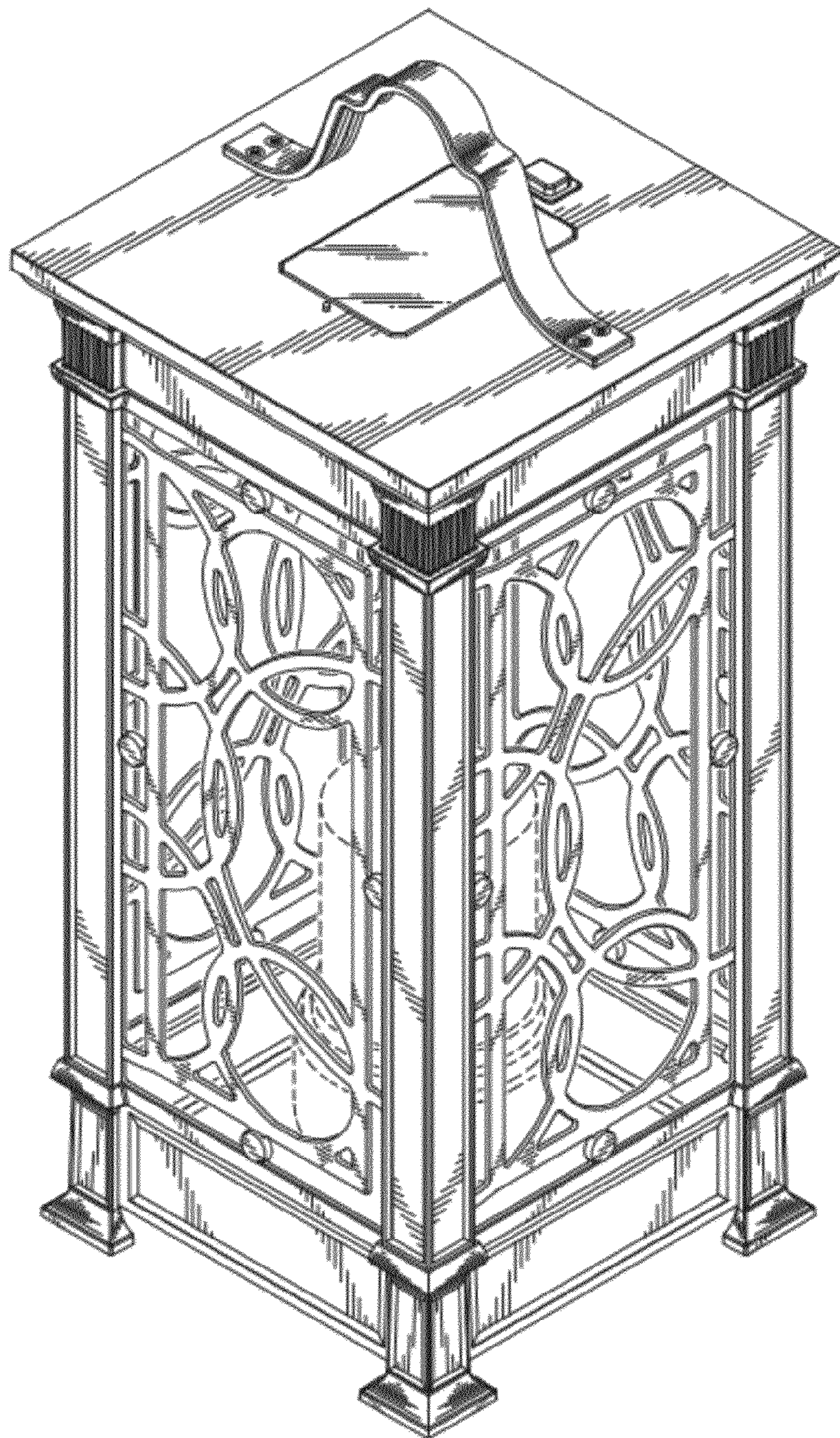

FIG. 1

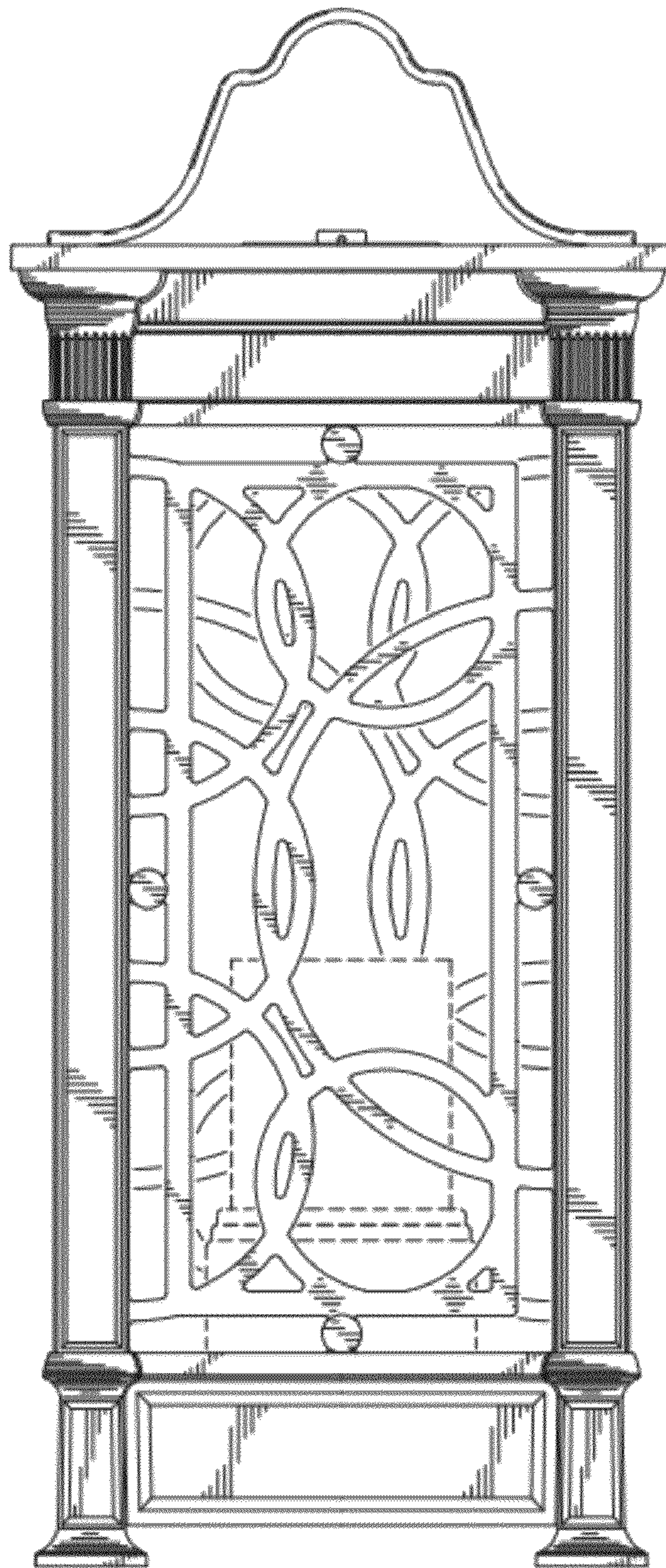

FIG. 2

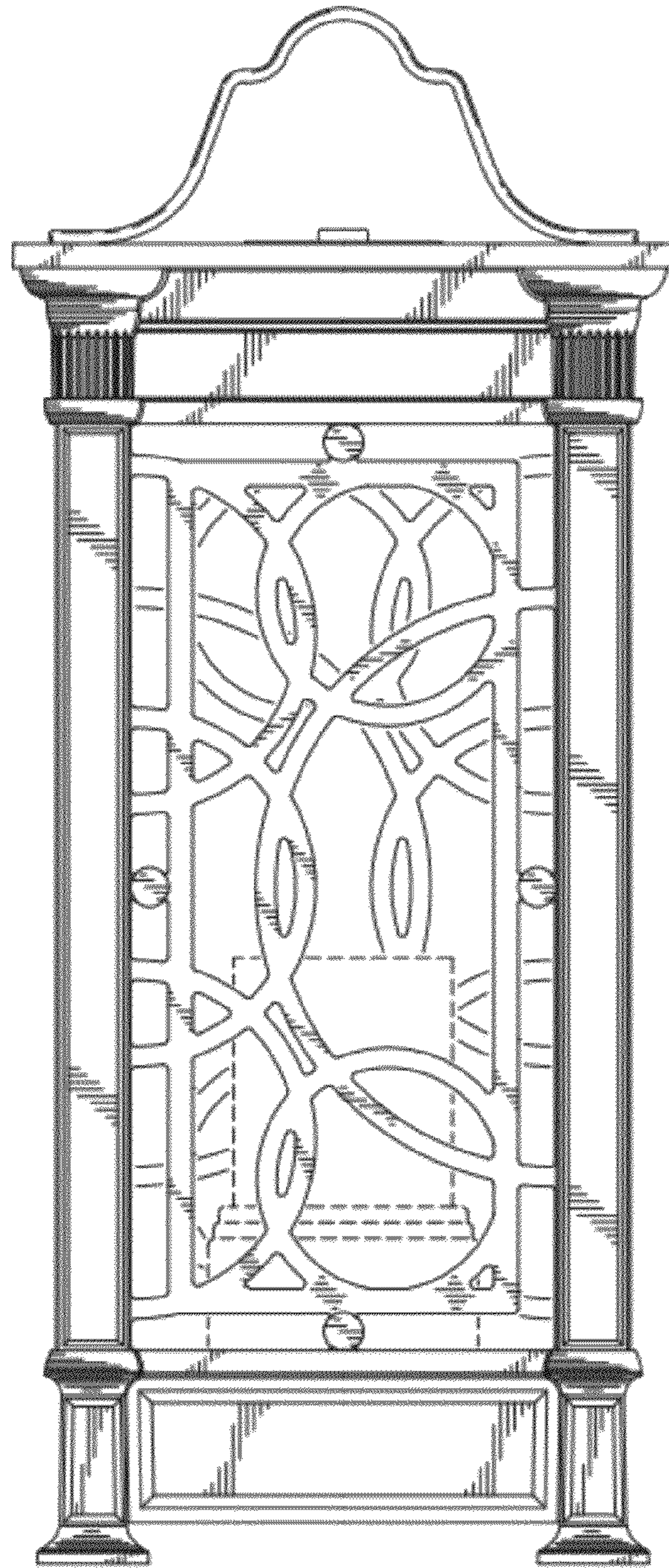

FIG. 3

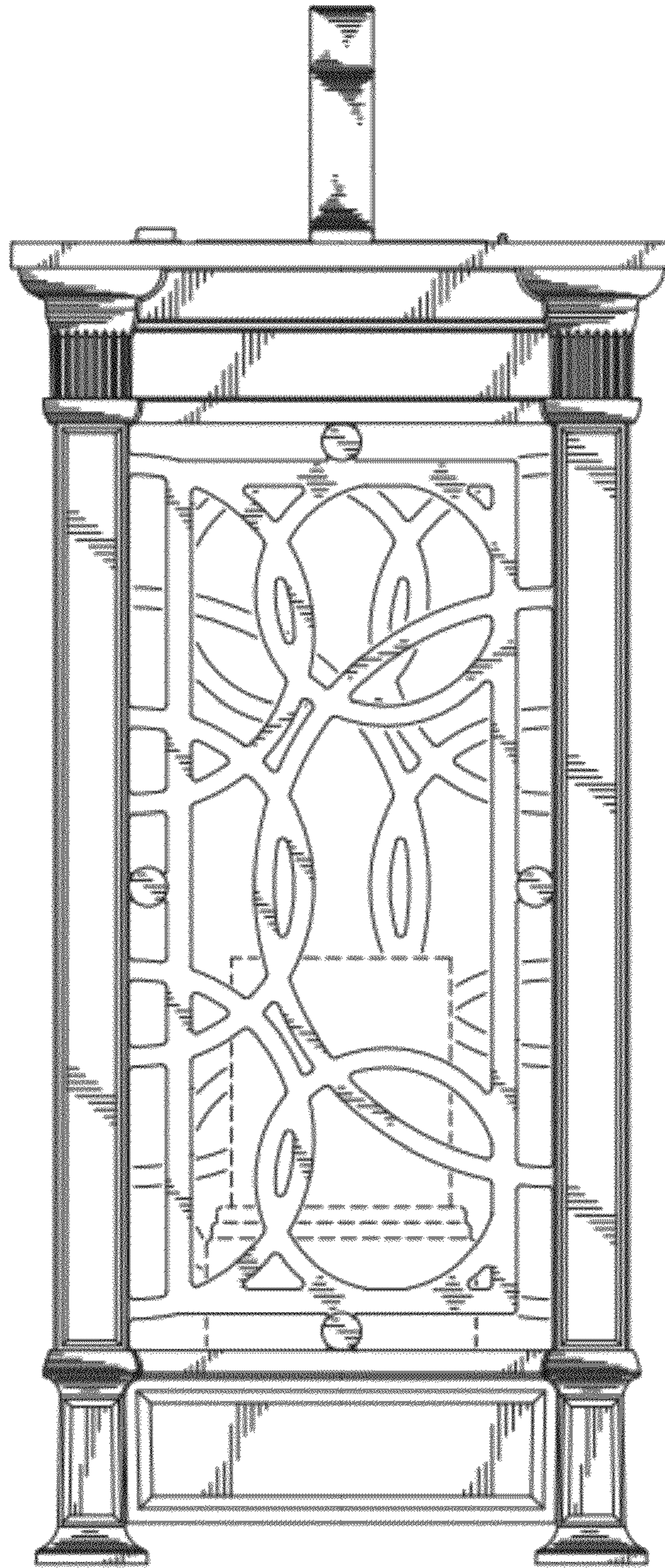

FIG. 4

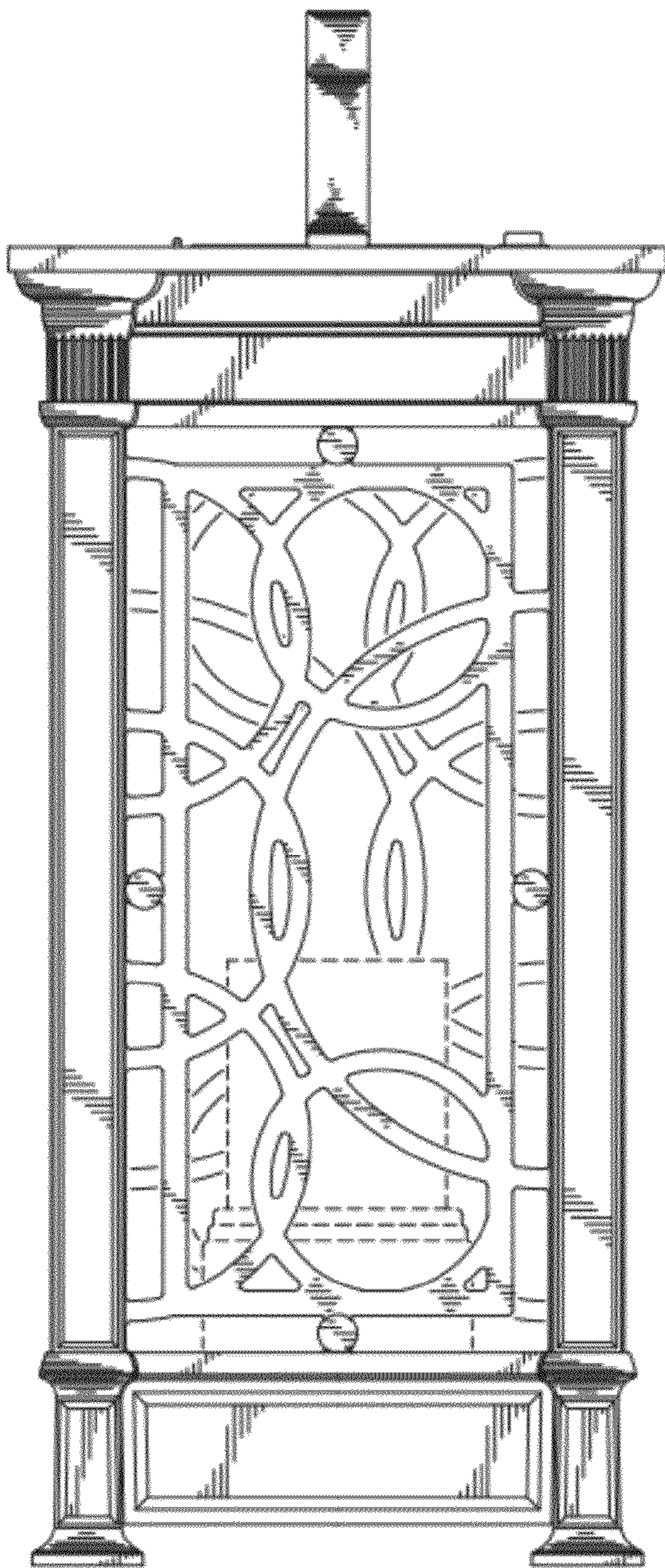

FIG. 5

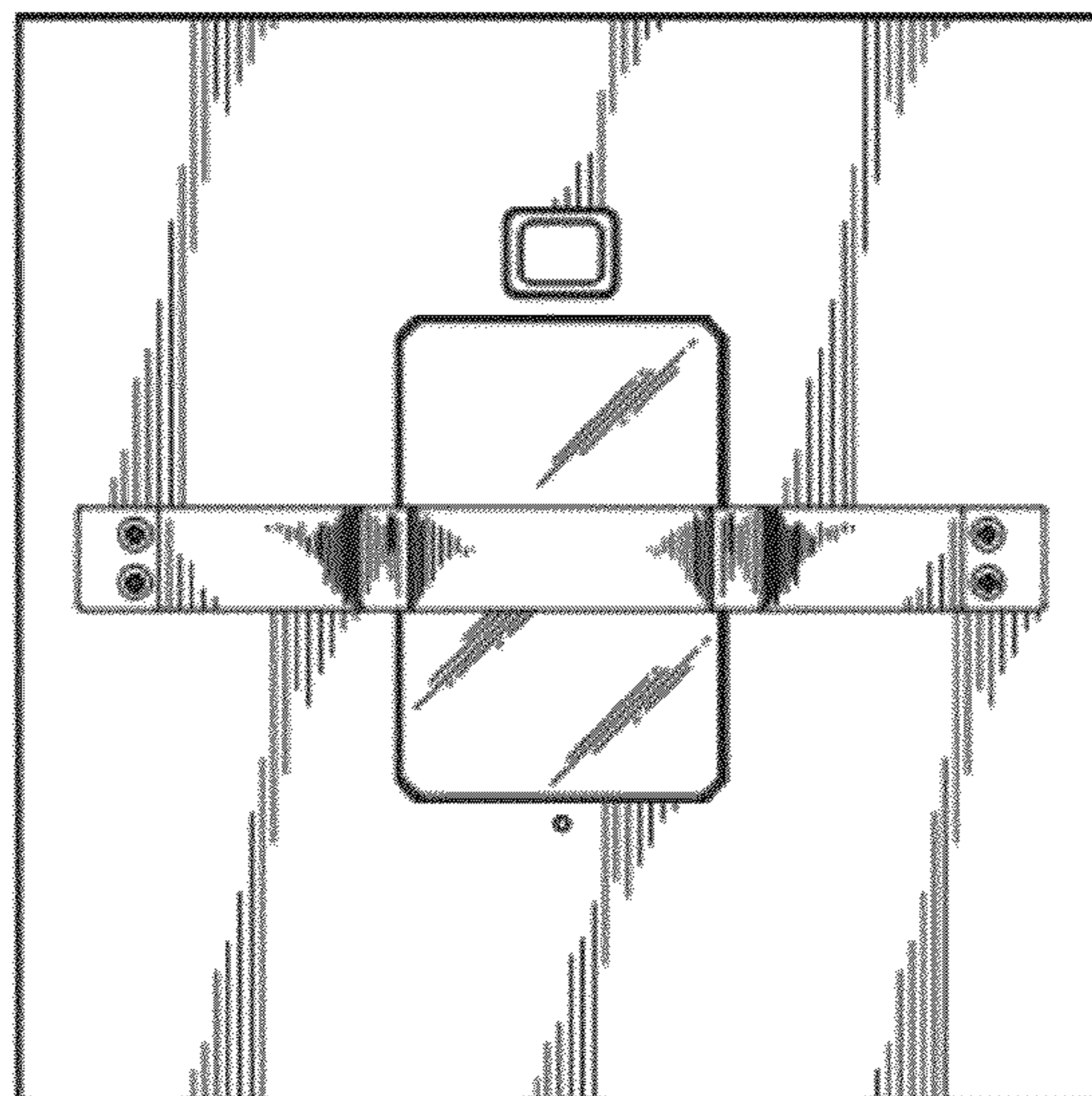

FIG. 6

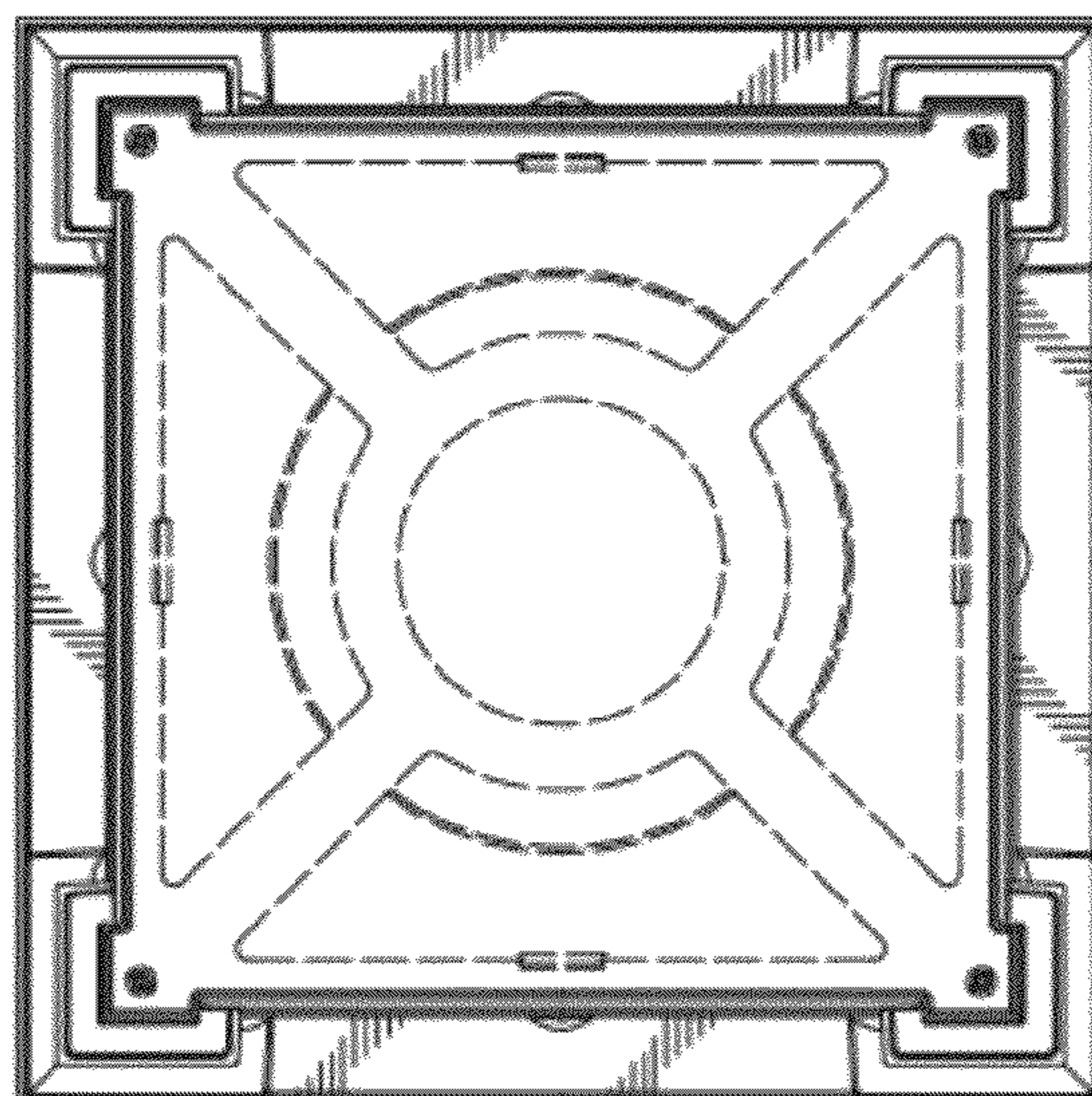

FIG. 7