



US00D662984S

(12) **United States Design Patent**
Yan

(10) **Patent No.:** **US D662,984 S**
(45) **Date of Patent:** **** Jul. 3, 2012**

- (54) **PEN**
- (75) Inventor: **Man Yan**, Ningbo (CN)
- (73) Assignee: **Beifa Group Co., Ltd.**, Ningbo (CN)
- (**) Term: **14 Years**
- (21) Appl. No.: **29/389,375**
- (22) Filed: **Apr. 11, 2011**
- (30) **Foreign Application Priority Data**

D563,473 S *	3/2008	Qiu et al.	D19/50
D576,213 S *	9/2008	Fei	D19/47
D580,490 S *	11/2008	Fei	D19/47
D585,492 S	1/2009	Booker		
D607,935 S *	1/2010	Shimada	D19/50
D609,744 S *	2/2010	Rathod	D19/48
D611,535 S *	3/2010	Shimizu	D19/48
D619,169 S *	7/2010	Kent et al.	D19/48
D619,170 S *	7/2010	Kent et al.	D19/55
D622,317 S	8/2010	Li		
D623,223 S	9/2010	Chaffee		
D628,643 S *	12/2010	Li	D19/50
D633,142 S	2/2011	Chaffee		
D641,405 S *	7/2011	Guo	D19/48
D648,387 S *	11/2011	Liang	D19/50
D651,241 S *	12/2011	Liang	D19/48

Oct. 14, 2010 (CN) 2010 3 0569237

- (51) **LOC (9) Cl.** **19-06**
- (52) **U.S. Cl.** **D19/50**
- (58) **Field of Classification Search** D19/35,
D19/36, 41-51, 54-58; D14/411; 24/11 F,
24/11 P, 11 R; 401/52, 99-109, 192, 195,
401/196

See application file for complete search history.

(56) **References Cited**

U.S. PATENT DOCUMENTS

D324,067 S	2/1992	Katami	
D430,209 S	8/2000	Rommel	
D450,347 S	11/2001	Keda	
D452,274 S	12/2001	Keda	
D467,614 S	12/2002	Pellissa Beneyto	
D492,349 S *	6/2004	Qiu D19/50
D496,688 S *	9/2004	Nishida D19/51
D499,139 S *	11/2004	Oka D19/47
D506,507 S *	6/2005	Qiu D19/51
D534,954 S *	1/2007	Bickert et al. D19/42
D534,955 S *	1/2007	Huxiong D19/50
D539,345 S *	3/2007	Bickert et al. D19/42
D540,386 S *	4/2007	Qiu D19/51
D540,861 S *	4/2007	Bickert et al. D19/42
D543,237 S *	5/2007	Bickert et al. D19/42
D548,788 S	8/2007	Anand	
D562,895 S *	2/2008	Shibata D19/50

OTHER PUBLICATIONS

Yuan, F., "Pen," U.S. Appl. No. 29/383,702, filed Jan. 20, 2011.
Yuan, F., "Pen," U.S. Appl. No. 29/383,704, filed Jan. 20, 2011.

* cited by examiner

Primary Examiner — Elizabeth Albert

(74) *Attorney, Agent, or Firm* — Christensen O'Connor Johnson Kindness PLLC

(57) **CLAIM**

The ornamental design for a pen, as shown and described.

DESCRIPTION

FIG. 1 is an upper front right perspective view of a pen showing my new design;
FIG. 2 is a front elevation view thereof;
FIG. 3 is a rear elevation view thereof;
FIG. 4 is a right side elevation view thereof, with the left side elevation view being a minor image of the right side elevation view;
FIG. 5 is an enlarged top plan view thereof; and,
FIG. 6 is an enlarged bottom plan view thereof.

1 Claim, 3 Drawing Sheets

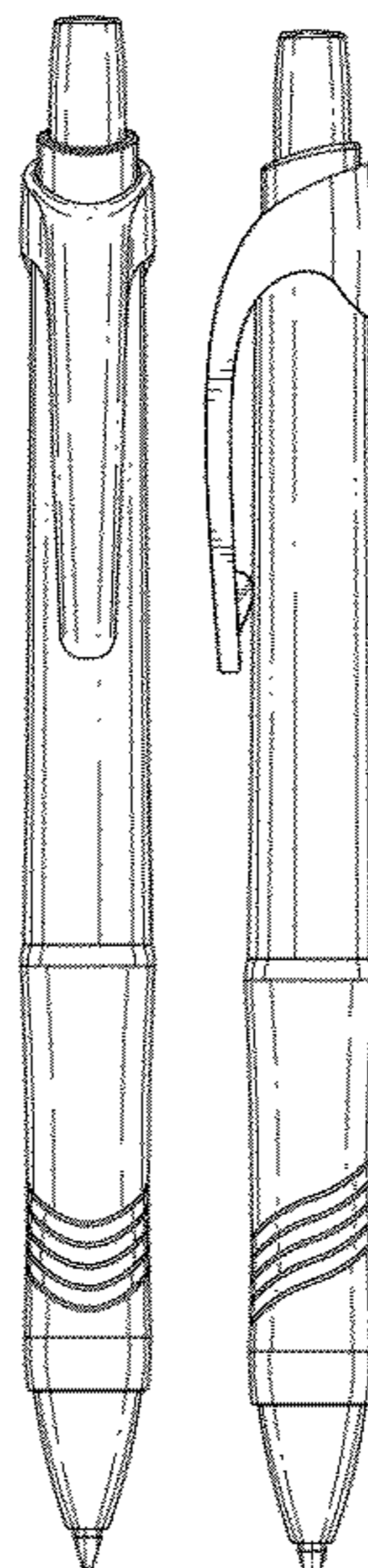

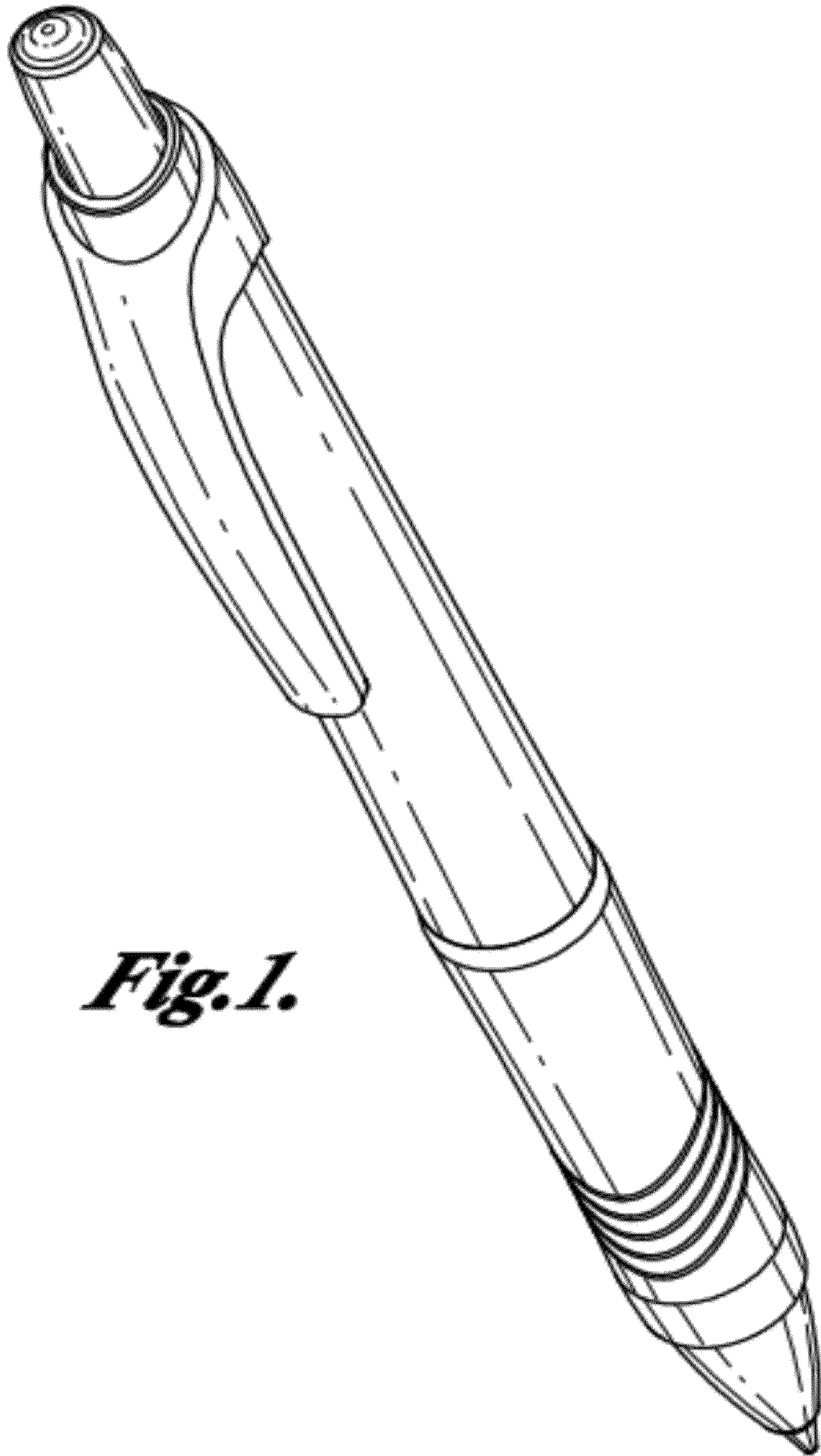

Fig. 1.

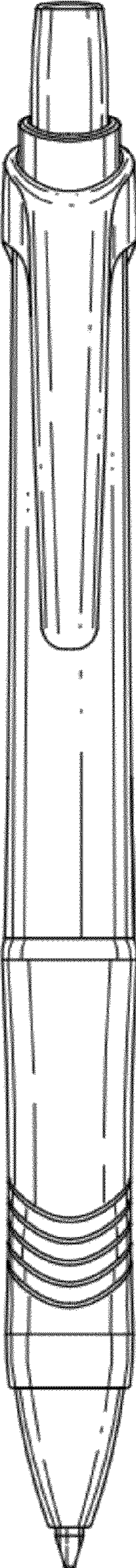

Fig. 2.

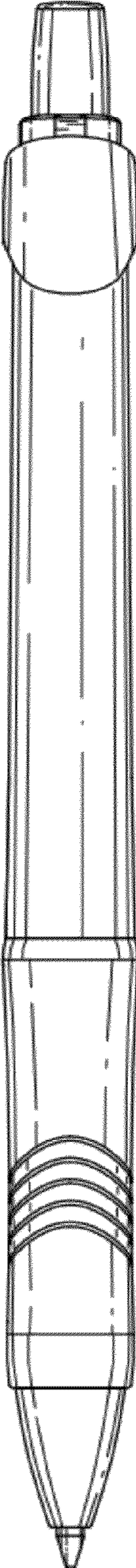

Fig. 3.

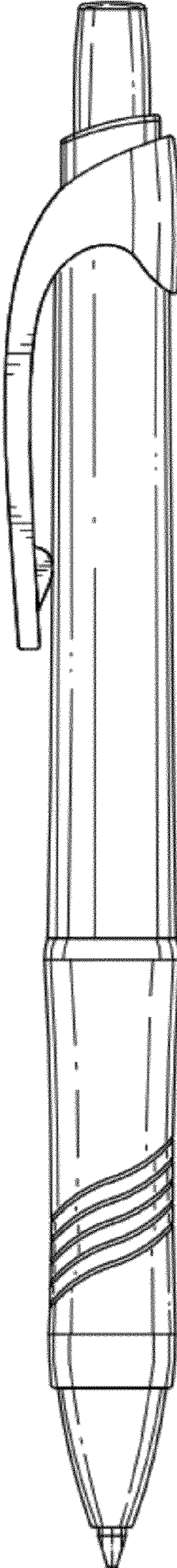

Fig. 4.

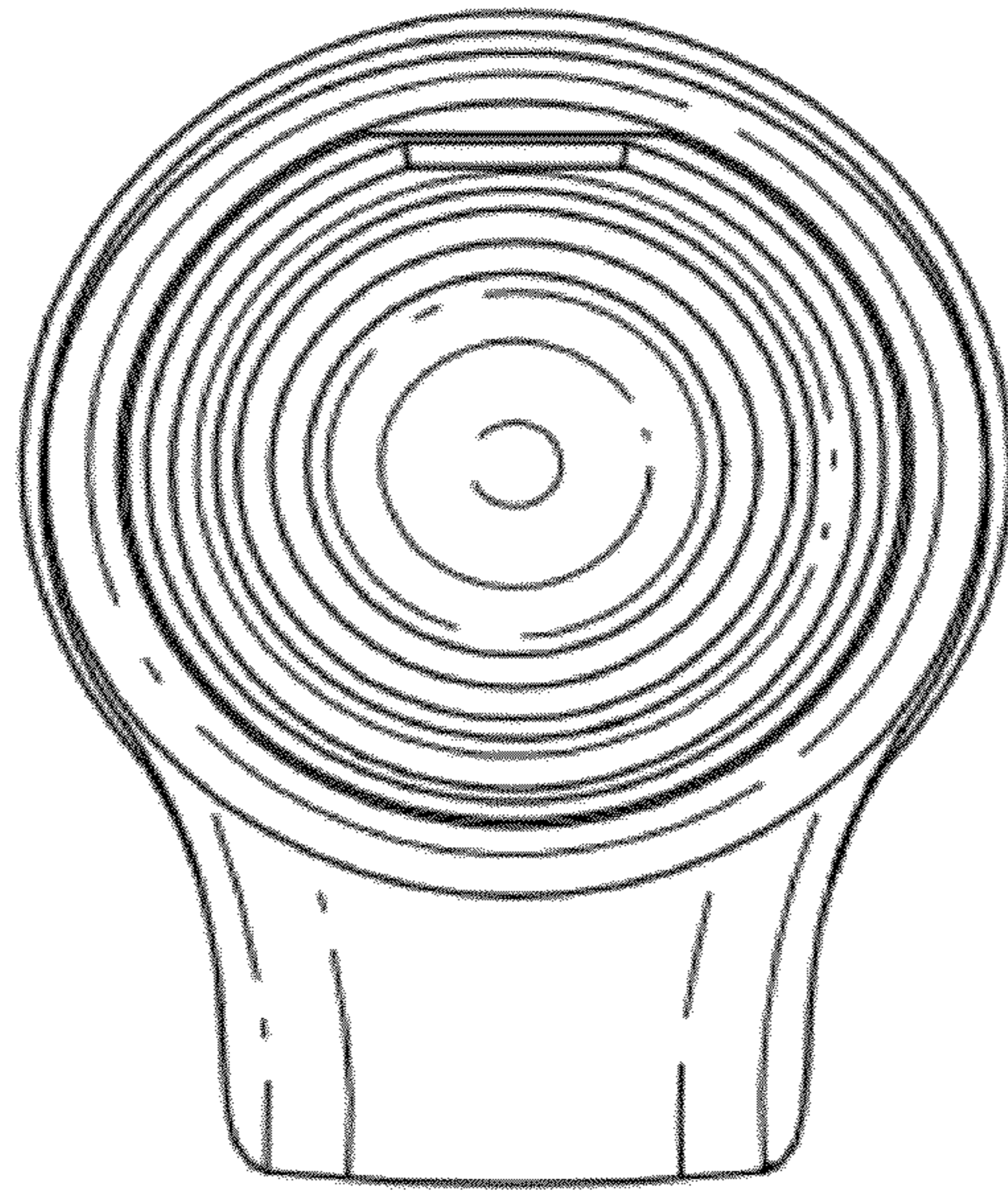

Fig. 5.

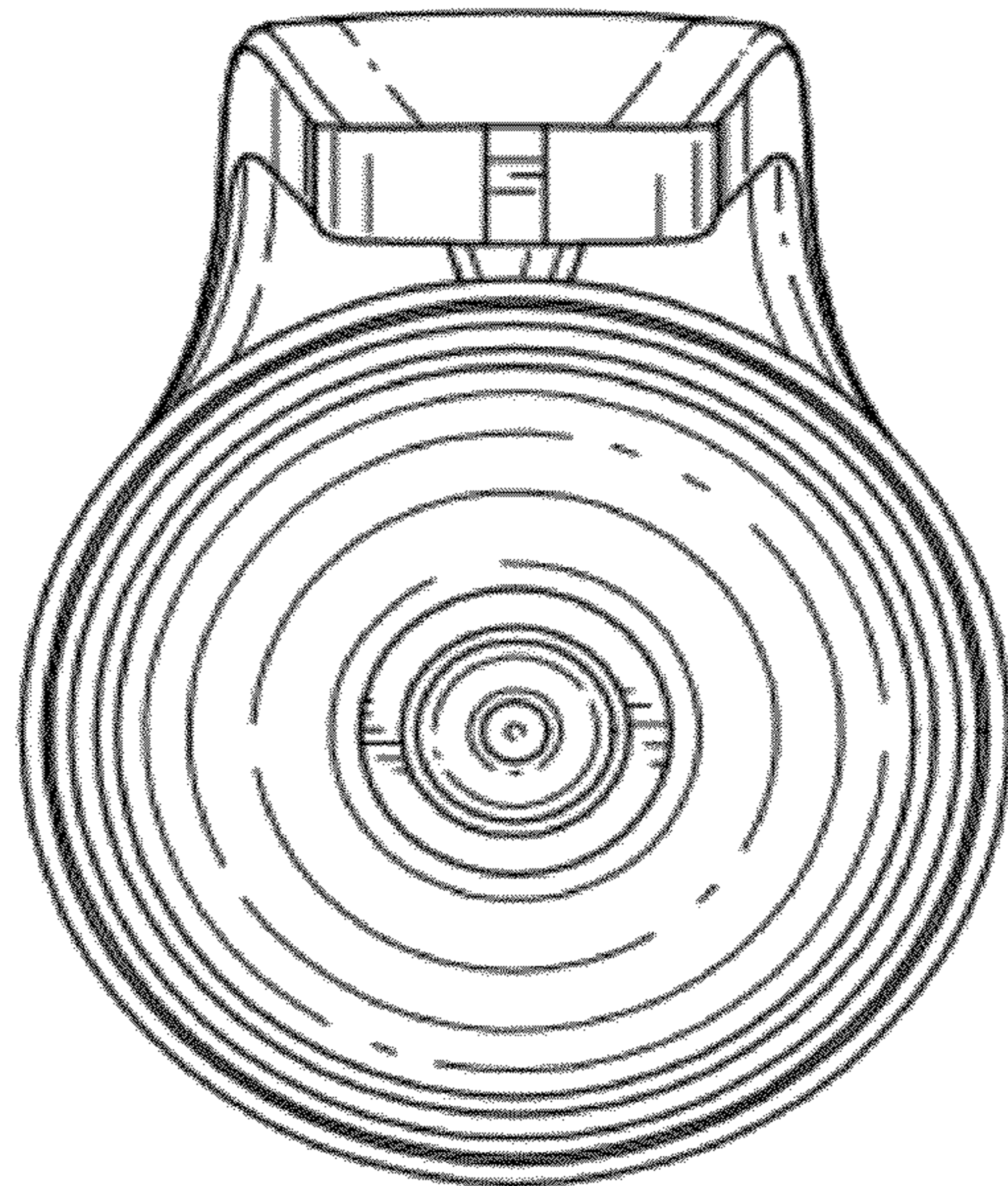

Fig. 6.

UNITED STATES PATENT AND TRADEMARK OFFICE
CERTIFICATE OF CORRECTION

PATENT NO. : D662,984 S
APPLICATION NO. : 29/389375
DATED : July 3, 2012
INVENTOR(S) : M. Yan

Page 1 of 1

It is certified that error appears in the above-identified patent and that said Letters Patent is hereby corrected as shown below:

On the title page:

(57)	Description	“a minor image” should read
Pg. 1, col. 2	6 of text	--a mirror image--

Signed and Sealed this
Twelfth Day of March, 2013



Teresa Stanek Rea
Acting Director of the United States Patent and Trademark Office