

US00D662927S

(12) **United States Design Patent**
Fahrendorff et al.

(10) **Patent No.:** **US D662,927 S**
(45) **Date of Patent:** **** Jul. 3, 2012**

(54) **DEVICE SKIN**

(75) Inventors: **Anders Fahrendorff**, Ottawa (CA); **Ian James Murchison**, Toronto (CA)

(73) Assignee: **Research In Motion Limited**, Waterloo, Ontario (CA)

(**) Term: **14 Years**

(21) Appl. No.: **29/389,906**

(22) Filed: **Apr. 18, 2011**

(51) **LOC (9) Cl.** **14-03**

(52) **U.S. Cl.** **D14/250**

(58) **Field of Classification Search** D14/250–253,
D14/440, 203.3–203.7, 217, 496, 248, 238.1;
D3/201, 218, 269, 301, 273, 303; D13/103,
D13/107–108; 220/4.02; 248/309.1; 361/679.56;
379/426, 433.11, 455; 455/575.1, 575.8;
190/100; 206/305, 320

See application file for complete search history.

(56) **References Cited**

U.S. PATENT DOCUMENTS

D597,089 S *	7/2009	Khan et al.	D14/250
D600,908 S *	9/2009	Richardson et al.	D3/218
D603,603 S *	11/2009	Laine et al.	D3/218
D609,463 S *	2/2010	Bullen	D3/218
D615,077 S *	5/2010	Richardson et al.	D14/250
D615,967 S *	5/2010	Richardson et al.	D14/250
D617,785 S *	6/2010	Richardson et al.	D14/250
D617,786 S *	6/2010	Richardson et al.	D14/250
D620,487 S *	7/2010	Richardson et al.	D14/250
D621,394 S *	8/2010	Richardson et al.	D14/250
D621,822 S *	8/2010	Richardson et al.	D14/250
D623,179 S *	9/2010	Richardson et al.	D14/250
D624,533 S *	9/2010	Richardson et al.	D14/250
D638,413 S *	5/2011	Magness et al.	D14/250
D638,830 S *	5/2011	Magness et al.	D14/250
D640,680 S *	6/2011	Magness et al.	D14/250
D644,635 S *	9/2011	Richardson et al.	D14/250
D651,594 S *	1/2012	Melanson et al.	D14/250

D653,658 S *	2/2012	Fahrendorff et al.	D14/250
D654,487 S *	2/2012	Weller et al.	D14/250
D654,492 S *	2/2012	Melanson et al.	D14/250
2009/0080153 A1 *	3/2009	Richardson et al.	361/679.56
2010/0104814 A1 *	4/2010	Richardson et al.	428/156

OTHER PUBLICATIONS

OtterBox Defender BlackBerry Bold 9900 Series Case, <URL:http://www.blackberrysource.com/store/products/otterBox-defender-blackberry-bold-9900-series-case-black.htm>, retrieved from internet on Mar. 24, 2012.*

Rubberized Case for BlackBerry Bold 9900/9930, <URL:http://www.blackberrysource.com/store/products/surface-for-blackberry-bold-9900-9930-black.htm>, retrieved from internet on Mar. 24, 2012.*

SeeThru Case for BlackBerry Bold, <URL:http://www.blackberrysource.com/store/catalog.asp?item=4594>, retrieved from internet on Mar. 24, 2012.*

Skin Emerge Case for BlackBerry Bold 9900, <URL:http://www.blackberrysource.com/store/products/blackberry-bold-9900-skin-emerge-case-pink.htm>, retrieved from internet on Mar. 25, 2012.*

* cited by examiner

Primary Examiner — Carla Wright

(57) **CLAIM**

We claim the ornamental design for a device skin, as shown and described.

DESCRIPTION

FIG. 1 is a back perspective view of a device skin; FIG. 2 is a front perspective view of the device skin; FIG. 3 is a back elevational view thereof; FIG. 4 is a front elevational view thereof; FIG. 5 is a right elevational view thereof; FIG. 6 is a left elevational view thereof; FIG. 7 is a top plan view thereof; and, FIG. 8 is a bottom plan view thereof. The broken lines in FIG. 5 indicate portions of the device skin that form no part of the claimed design.

1 Claim, 6 Drawing Sheets

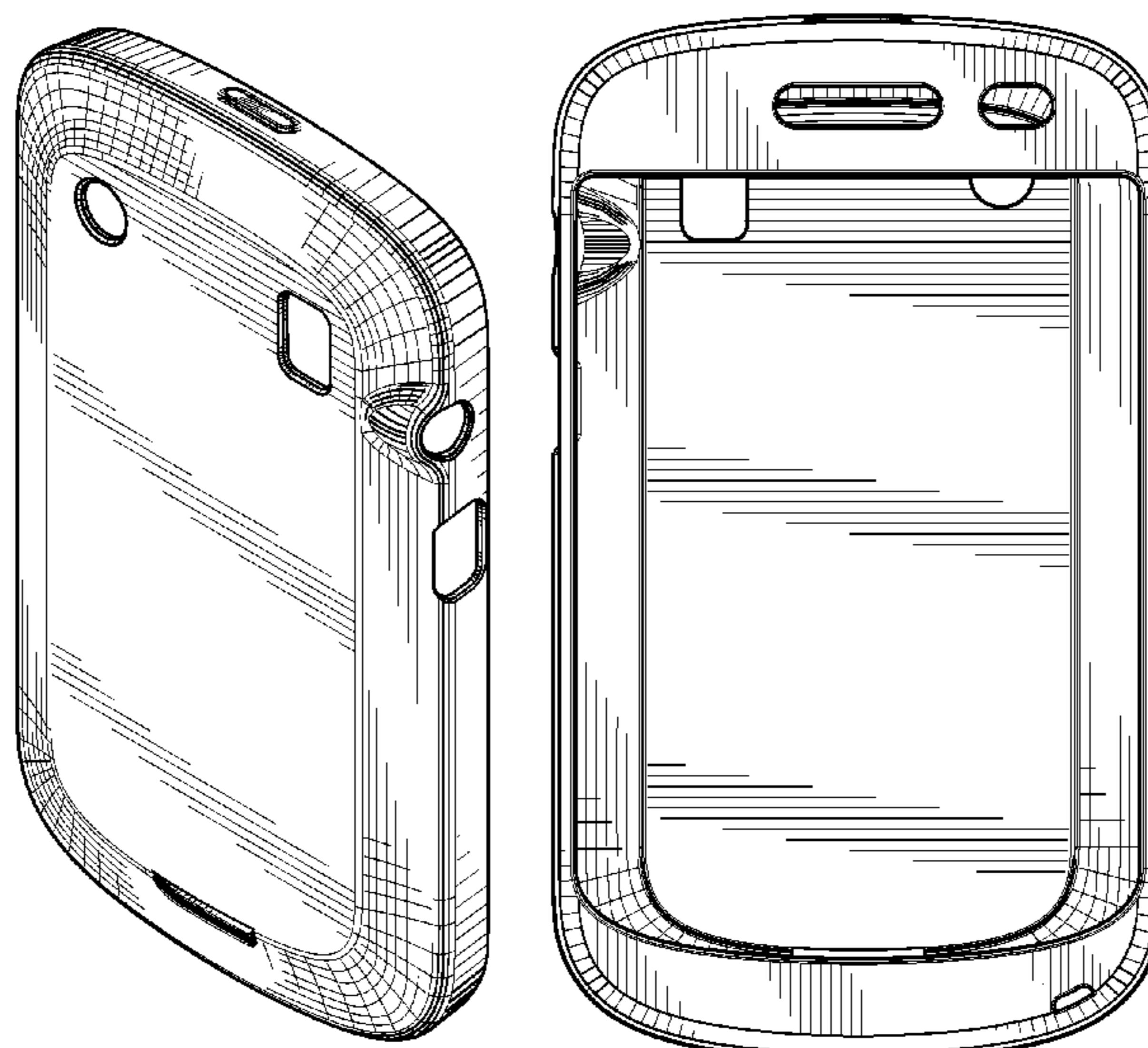

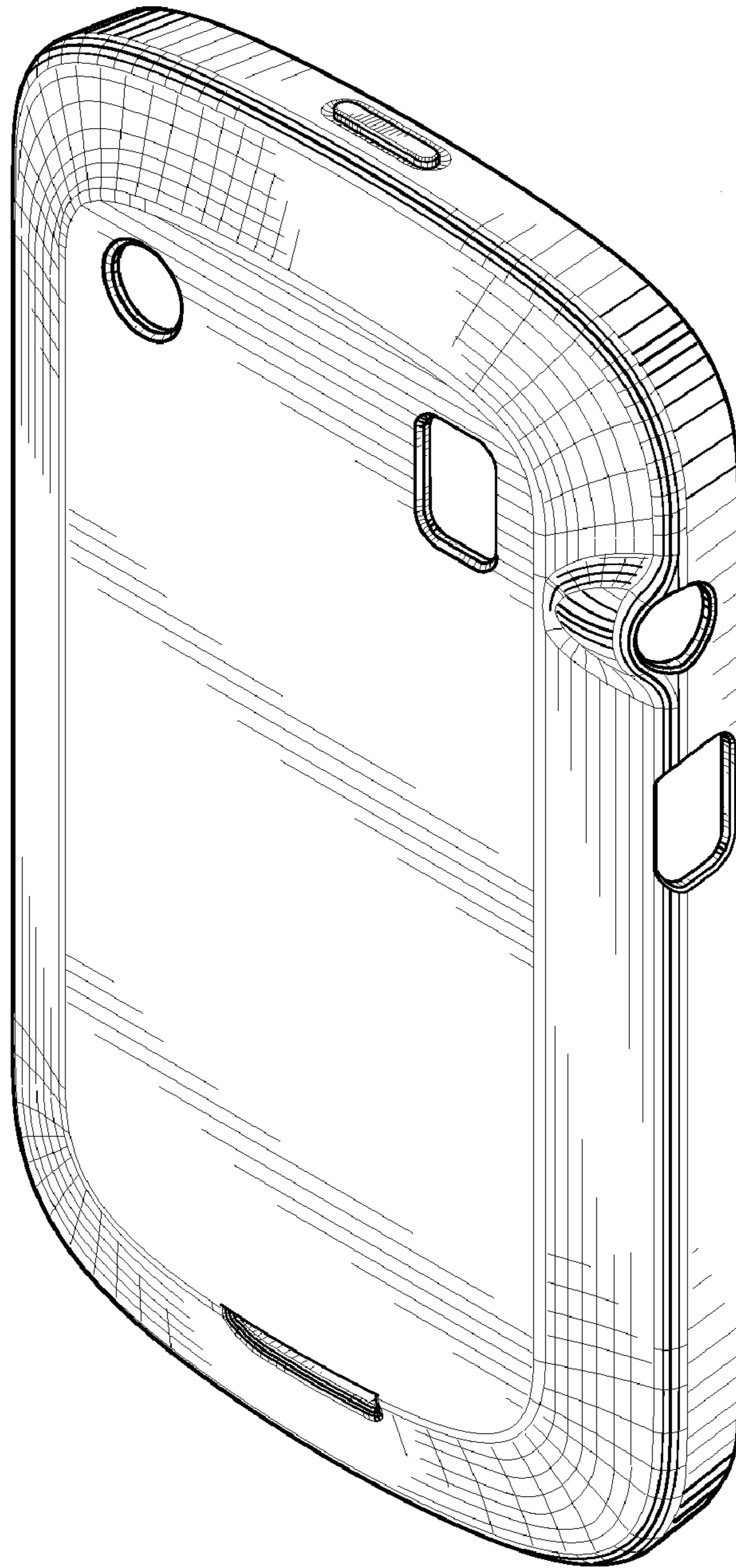

FIG.1

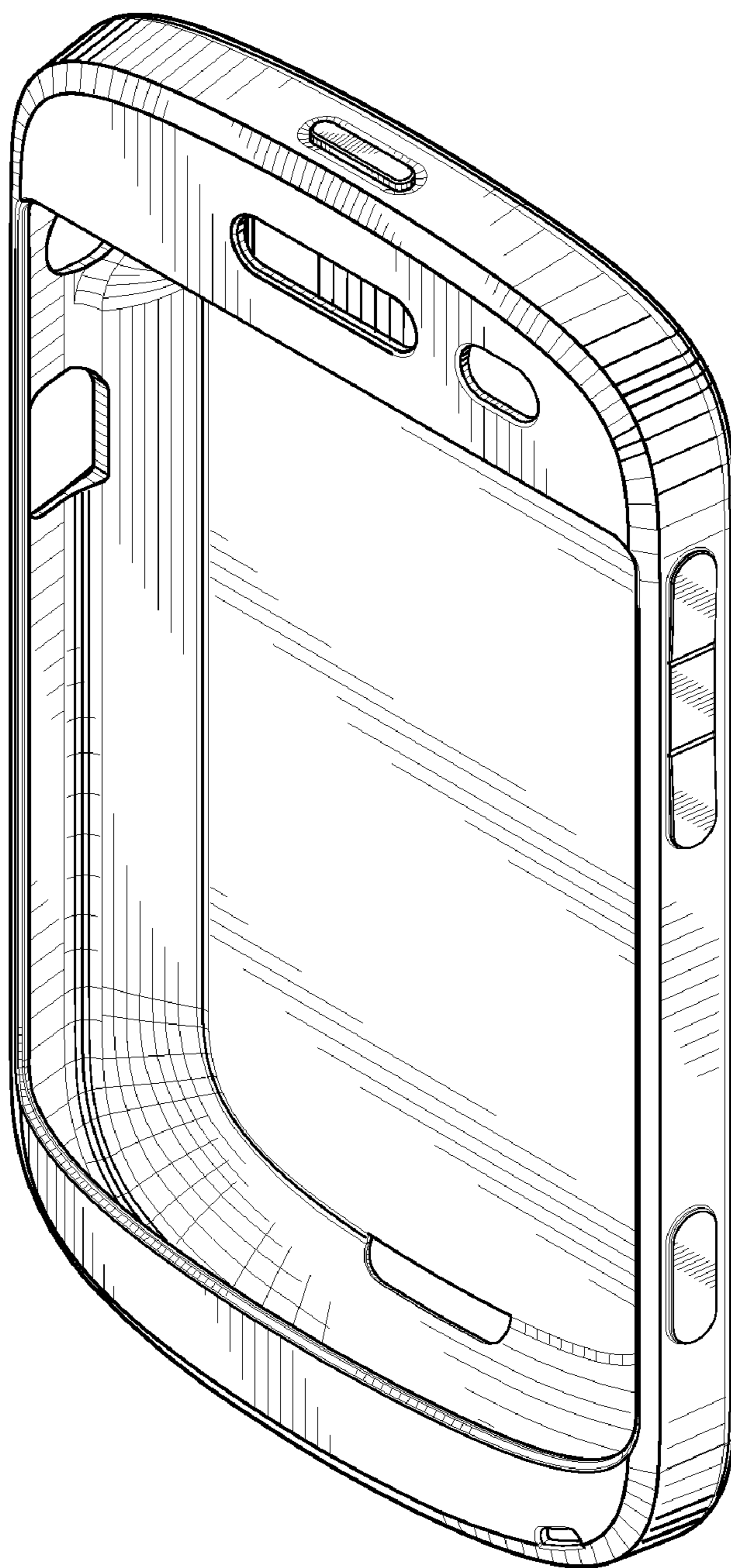

FIG.2

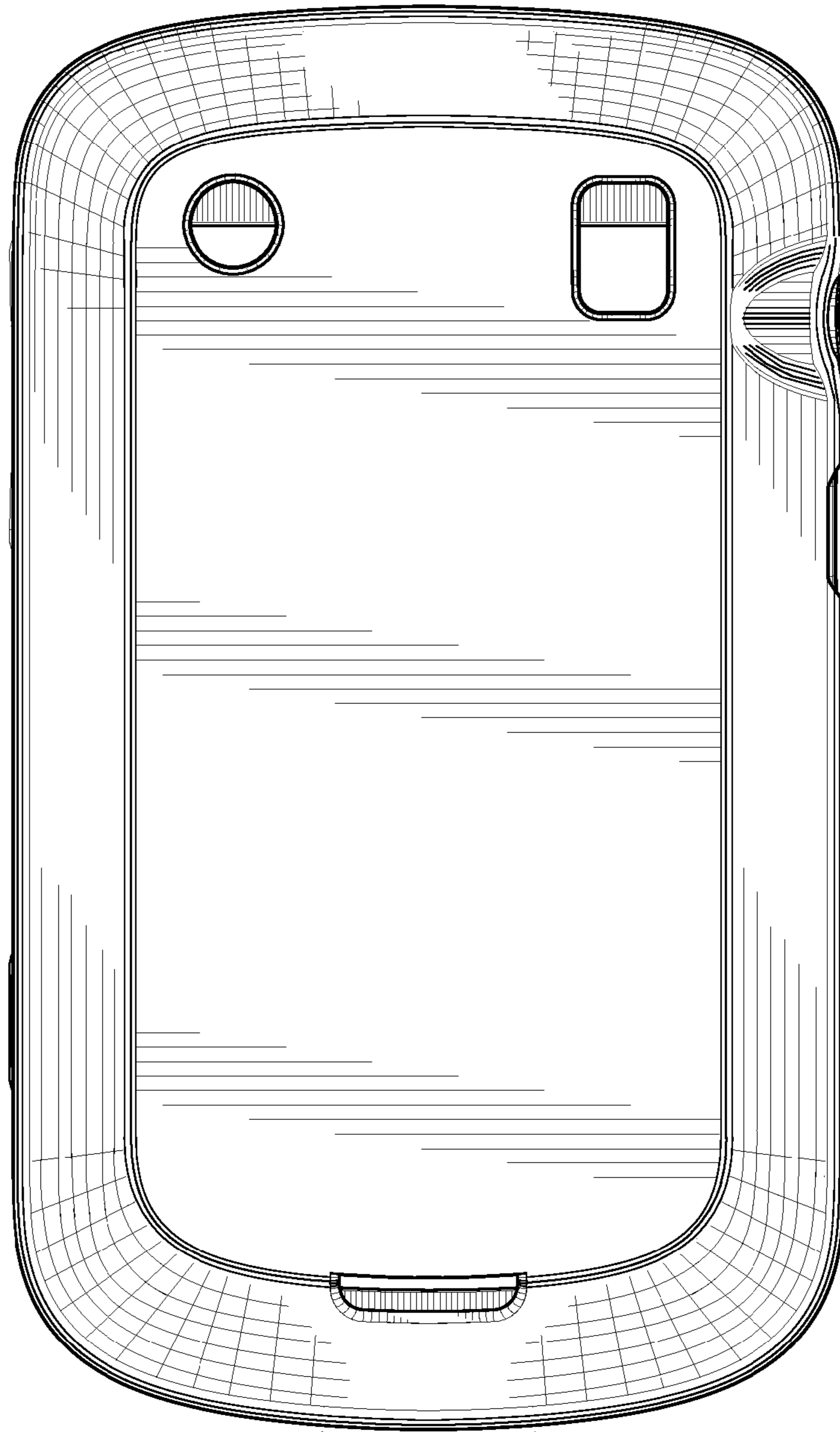

FIG.3

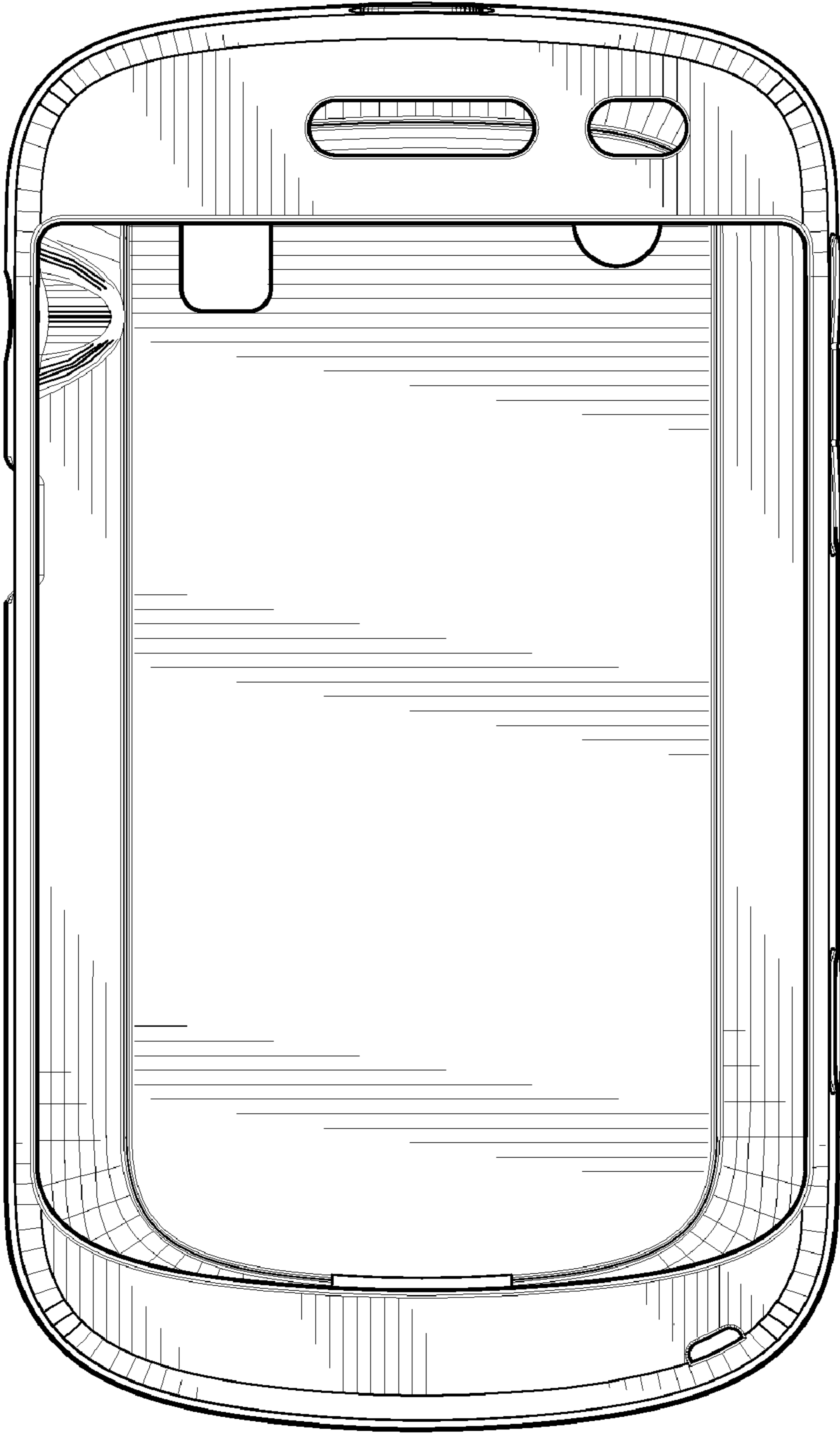

FIG.4

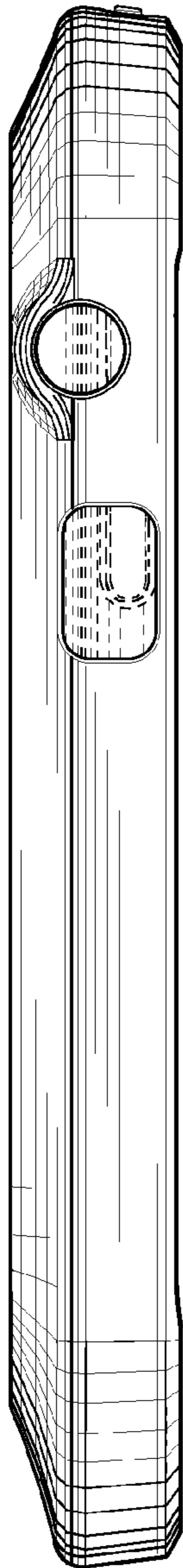

FIG. 5

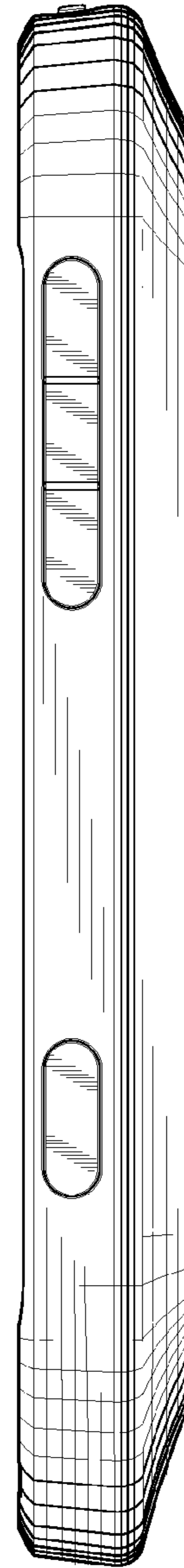

FIG. 6

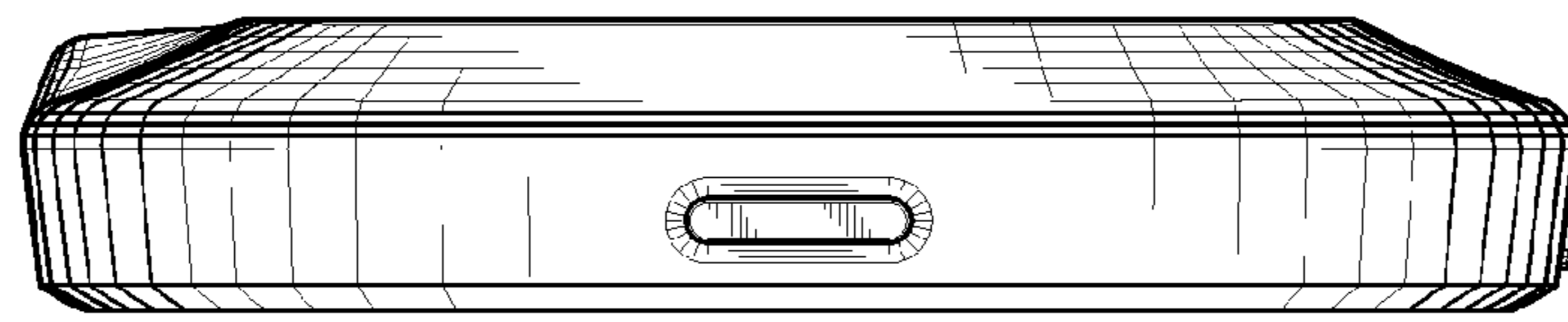

FIG. 7

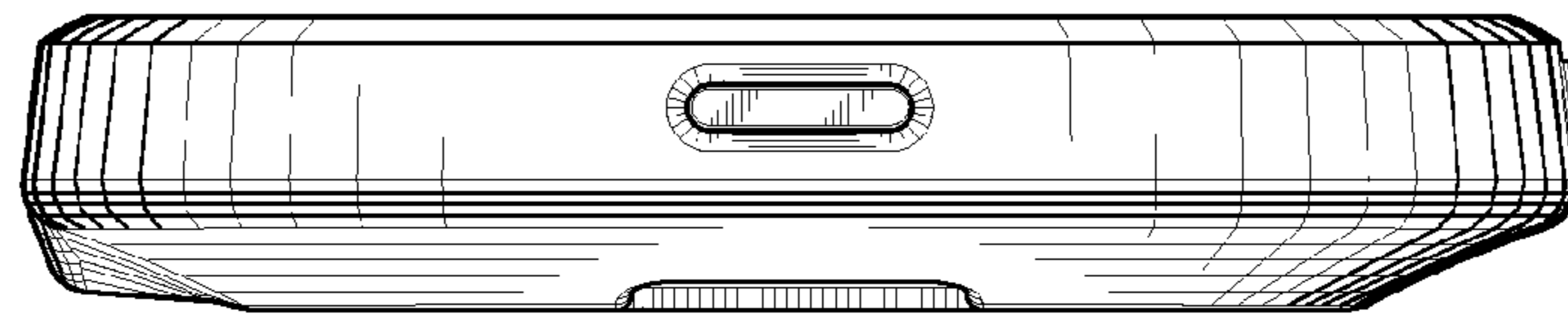

FIG. 8