



US00D662836S

(12) **United States Design Patent**
Ganz

(10) **Patent No.:** **US D662,836 S**

(45) **Date of Patent:** **** Jul. 3, 2012**

- (54) **WRIST WATCH CASE**
- (75) Inventor: **Steffen Ganz**, Zell am See (AT)
- (73) Assignee: **Porsche Lizenz und
Handelsgesellschaft mbH & Co. KG**
(DE)
- (**) Term: **14 Years**
- (21) Appl. No.: **29/412,235**
- (22) Filed: **Feb. 1, 2012**
- (51) **LOC (9) Cl.** **10-02**
- (52) **U.S. Cl.** **D10/38**
- (58) **Field of Classification Search** D10/30-39;
368/276, 281, 282, 285
See application file for complete search history.

D473,473 S *	4/2003	Wunderman	D10/32
D508,859 S *	8/2005	Ho	D10/30
D520,384 S *	5/2006	Scheufele	D10/39
D535,199 S *	1/2007	Lassigne	D10/32
D538,184 S *	3/2007	Scheufele	D10/39
D545,697 S *	7/2007	Martin	D10/38
D590,276 S *	4/2009	Miloradovic	D10/32
D632,980 S *	2/2011	Yurman	D10/38
D652,325 S *	1/2012	Ahlstrom	D10/38

* cited by examiner

Primary Examiner — Lucy Lieberman

(74) *Attorney, Agent, or Firm* — Gerald E. Hespos; Michael J. Porco

(57) **CLAIM**

The ornamental design for a wrist watch case, as shown.

DESCRIPTION

FIG. 1 is a perspective view of a wrist watch case in accordance with my design;
 FIG. 2 is a top plan view of the wrist watch case of FIG. 1;
 FIG. 3 is a front elevational view of the wrist watch case shown in FIGS. 1 and 2;
 FIG. 4 is a rear elevational view thereof;
 FIG. 5 is a right side elevational view thereof;
 FIG. 6 is a left side elevation view thereof; and,
 FIG. 7 is a bottom plan view thereof.

1 Claim, 5 Drawing Sheets

(56) **References Cited**

U.S. PATENT DOCUMENTS

3,431,722 A *	3/1969	Haas	235/61 R
3,503,203 A *	3/1970	Gruner et al.	368/21
D329,612 S *	9/1992	Hysek	D10/39
D369,302 S *	4/1996	Wood	D10/32
D447,063 S *	8/2001	Scheufele	D10/30
D447,705 S *	9/2001	Scheufele	D10/39
D467,820 S *	12/2002	Berliat	D10/39

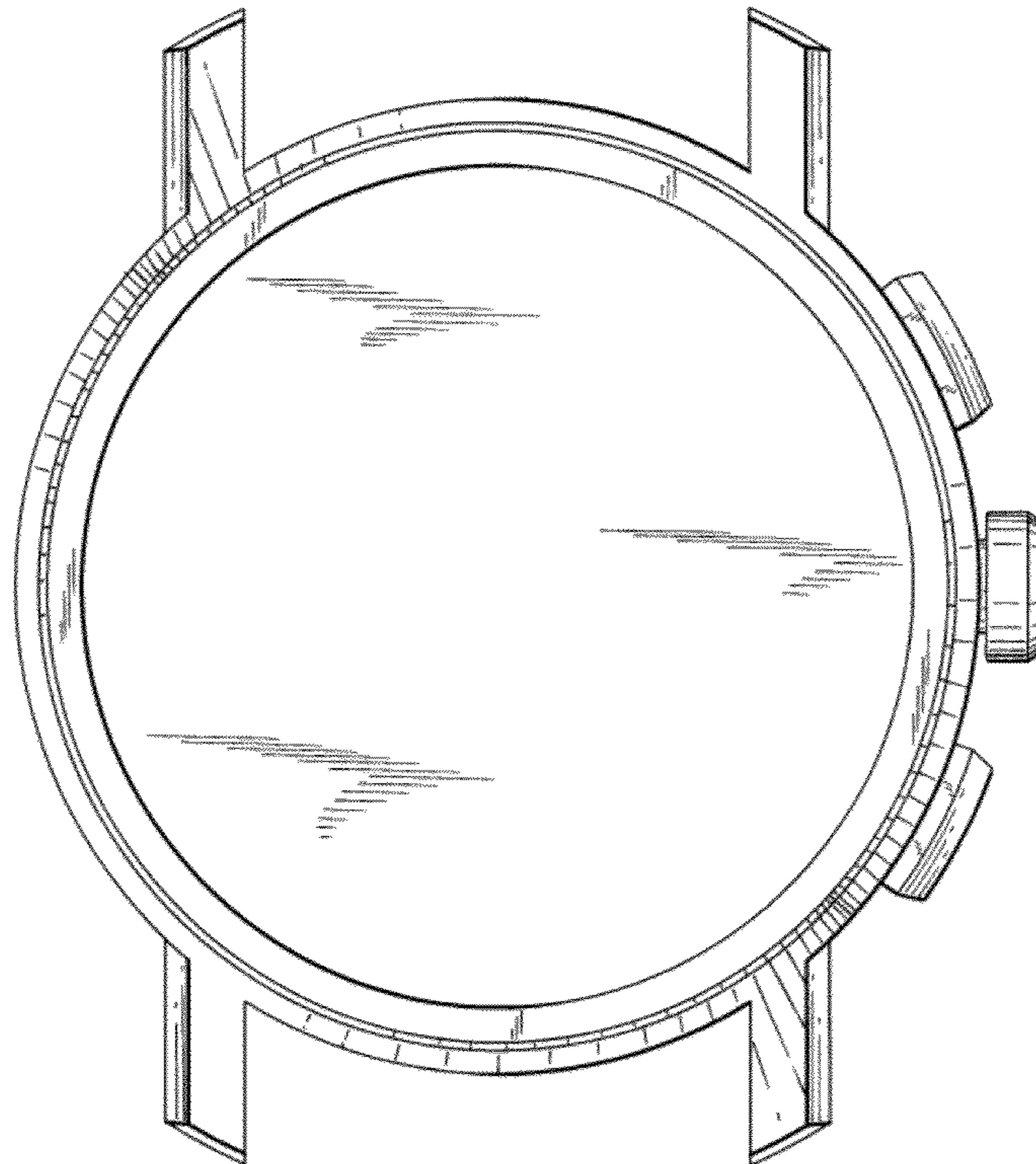

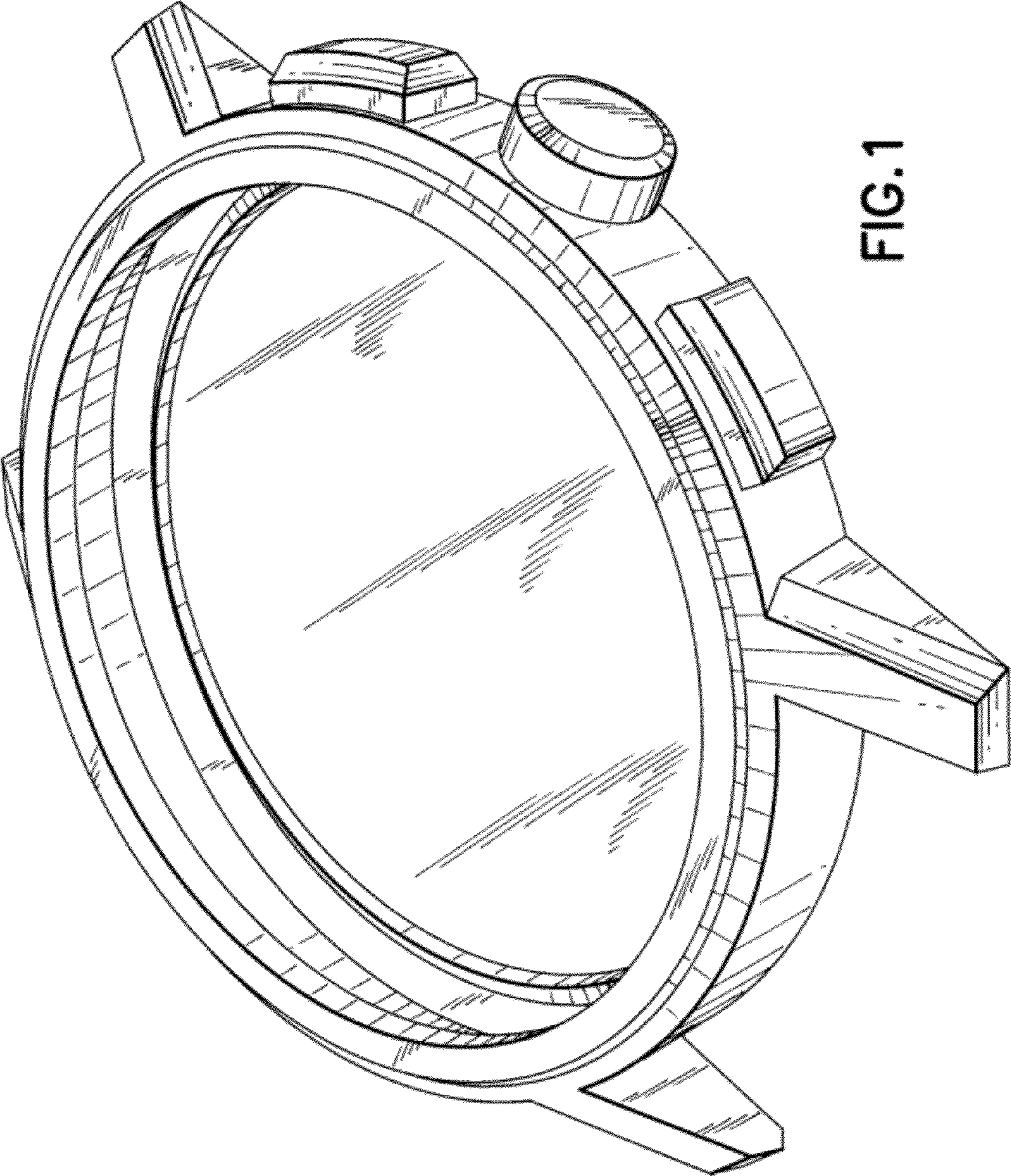

FIG. 1

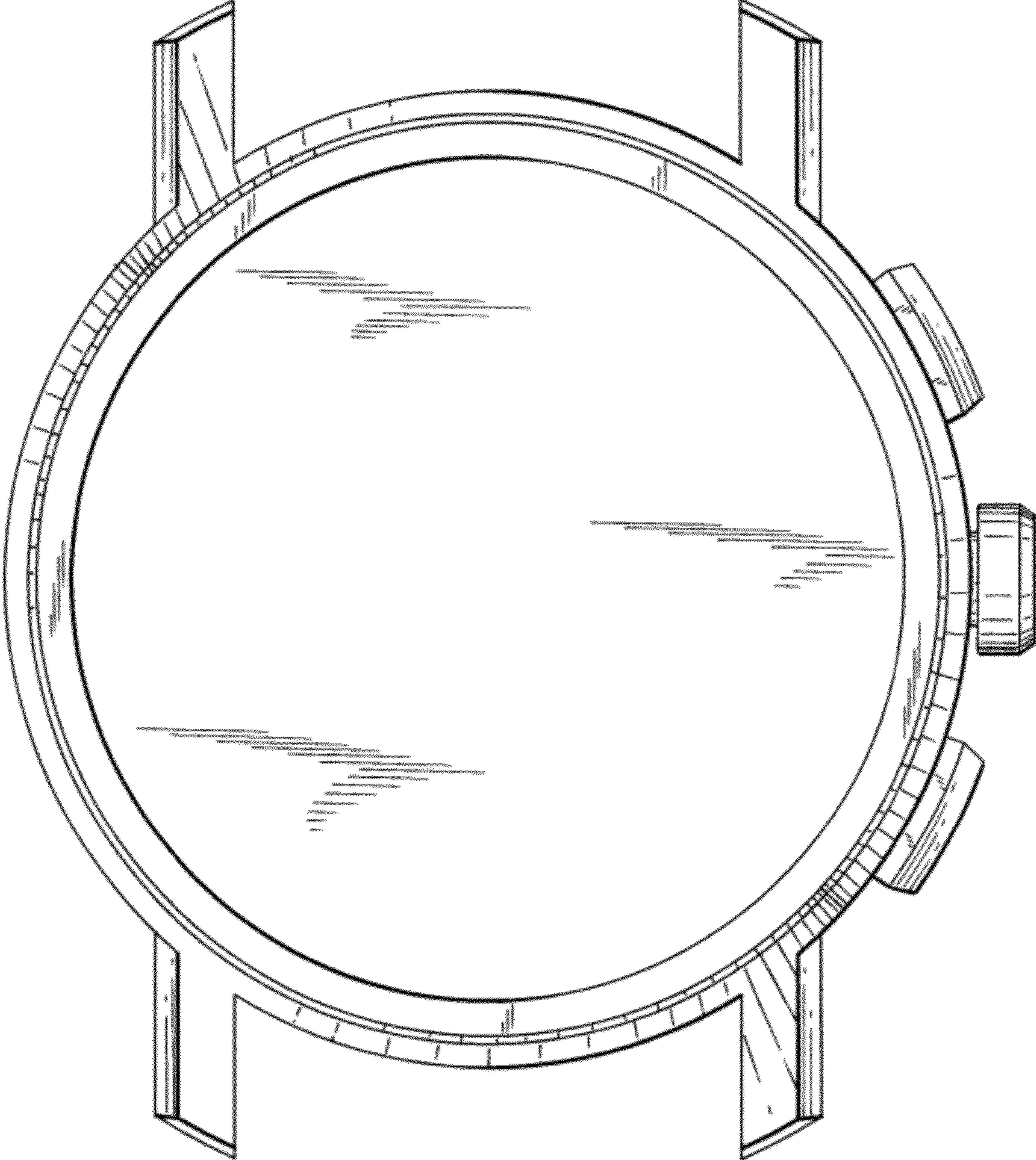

FIG. 2

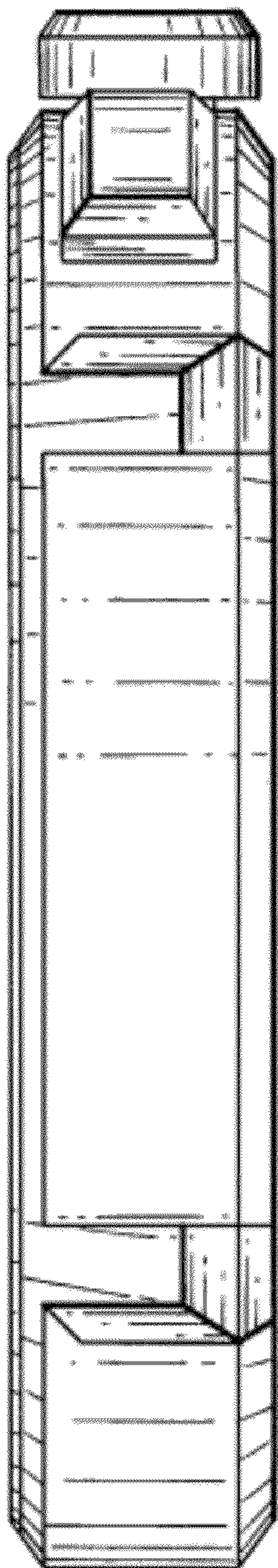

FIG. 3

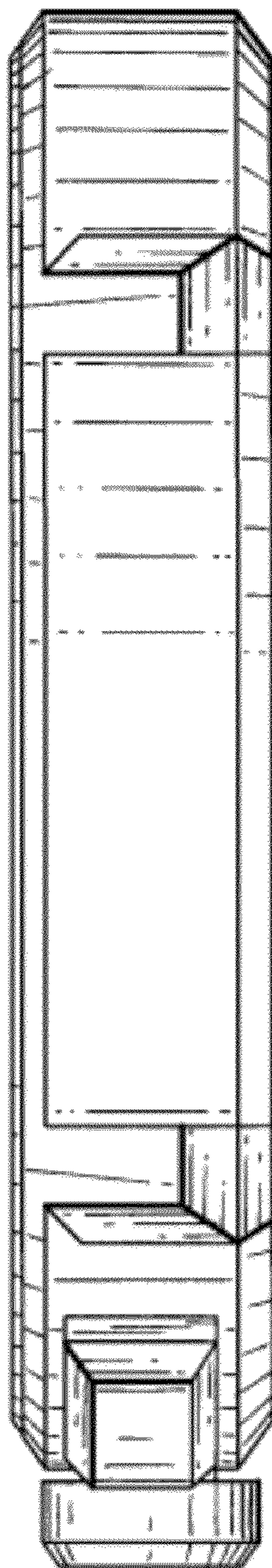

FIG. 4

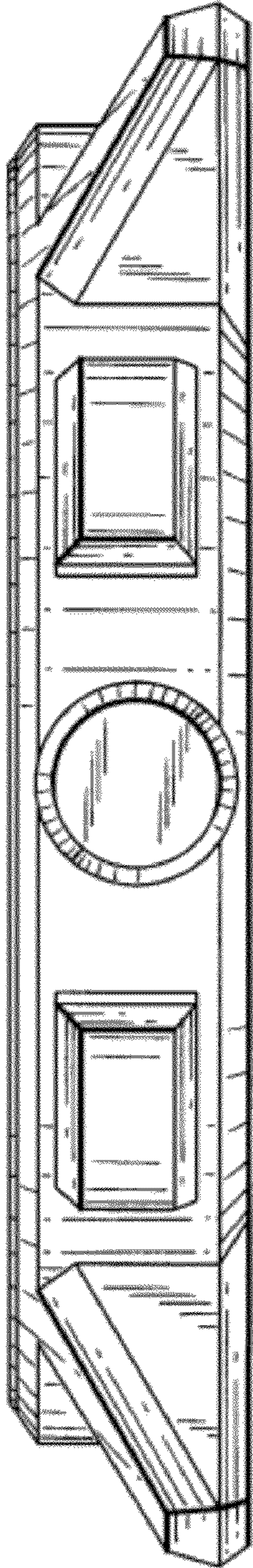

FIG. 5

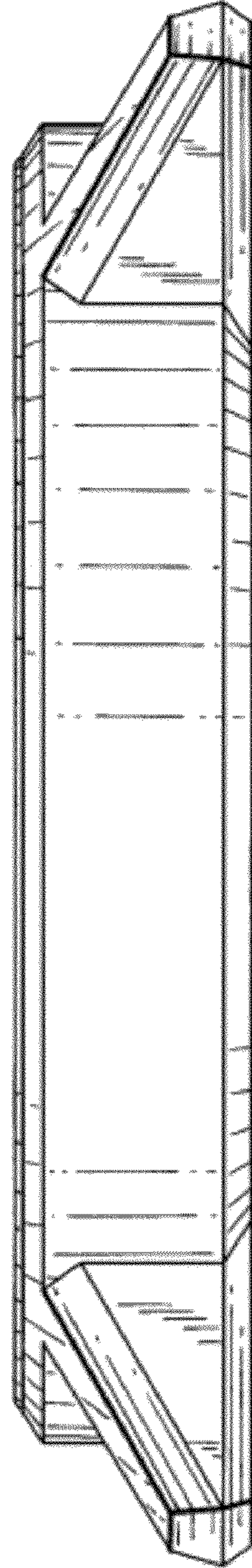

FIG. 6

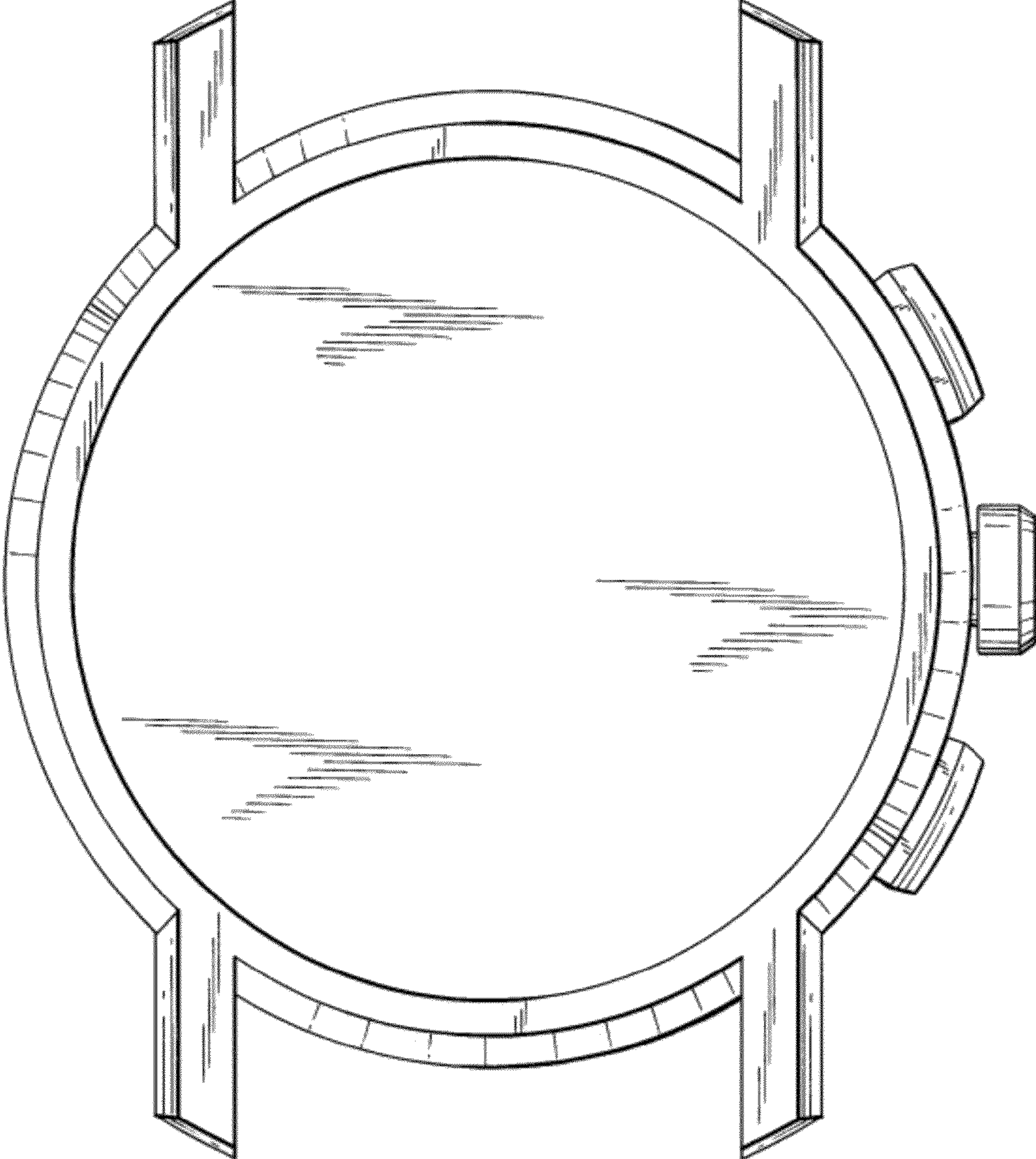

FIG. 7