



US00D662785S

(12) **United States Design Patent**
Kern et al.

(10) **Patent No.:** **US D662,785 S**

(45) **Date of Patent:** **** Jul. 3, 2012**

(54) **UTENSIL HOLDER**

(75) Inventors: **Elizabeth C. Kern**, Minneapolis, MN (US); **Ashley L. Kneller**, Minneapolis, MN (US); **Rachel A. Jones**, Minneapolis, MN (US)

(73) Assignee: **Target Brands, Inc.**, Minneapolis, MN (US)

(**) Term: **14 Years**

(21) Appl. No.: **29/384,572**

(22) Filed: **Feb. 1, 2011**

(51) **LOC (9) Cl.** **07-06**

(52) **U.S. Cl.** **D7/641; D32/55**

(58) **Field of Classification Search** D7/637-641, D7/603-608; D32/55-57, 3; 211/10, 11, 211/69.1-69.9, 41.4; 220/607, 606, 449, 220/494, 488, 485, 902, 903; 215/12.1, 12.2, 215/13.1; 210/94, 86, 241, 338

See application file for complete search history.

(56) **References Cited**

U.S. PATENT DOCUMENTS

3,529,742 A * 9/1970 Cumming 220/606
D287,175 S * 12/1986 Gecchelin D32/55
D305,193 S * 12/1989 Sajadieh D7/509
D333,594 S 3/1993 Lin

(Continued)

OTHER PUBLICATIONS

Aspen Grove, "Bamboo utensil holder", p. 1 of 1, http://www.aspengrovehome.com/images/BOO-TH_wELAs.jpg (last visited Nov. 17, 2010).

Primary Examiner — Terry Wallace

(74) *Attorney, Agent, or Firm* — Leanne Taveggia Farrell; Westman, Champlin & Kelly, P.A.

(57) **CLAIM**

The ornamental design for a utensil holder, as shown and described.

DESCRIPTION

FIG. 1 is a perspective view of one embodiment of the utensil holder.

FIG. 2 is a left side view of the utensil holder illustrated in FIG. 1.

FIG. 3 is a right side view of the utensil holder illustrated in FIG. 1.

FIG. 4 is a front view of the utensil holder illustrated in FIG. 1.

FIG. 5 is a back view of the utensil holder illustrated in FIG. 1.

FIG. 6 is a top view of the utensil holder illustrated in FIG. 1.

FIG. 7 is a bottom view of the utensil holder illustrated in FIG. 1.

FIG. 8 is a sectional view of the utensil holder illustrated in FIG. 1.

FIG. 9 is a perspective view of a second embodiment of the utensil holder.

FIG. 10 is a left side view of the utensil holder illustrated in FIG. 9.

FIG. 11 is a right side view of the utensil holder illustrated in FIG. 9.

FIG. 12 is a front view of the utensil holder illustrated in FIG. 9.

FIG. 13 is a back view of the utensil holder illustrated in FIG. 9.

FIG. 14 is a top view of the utensil holder illustrated in FIG. 9.

FIG. 15 is a bottom view of the utensil holder illustrated in FIG. 9; and,

FIG. 16 is a sectional view of the utensil holder illustrated in FIG. 9.

The broken lines in FIGS. 5, 7, 8 and 13-16 form no part of the claimed design.

1 Claim, 16 Drawing Sheets

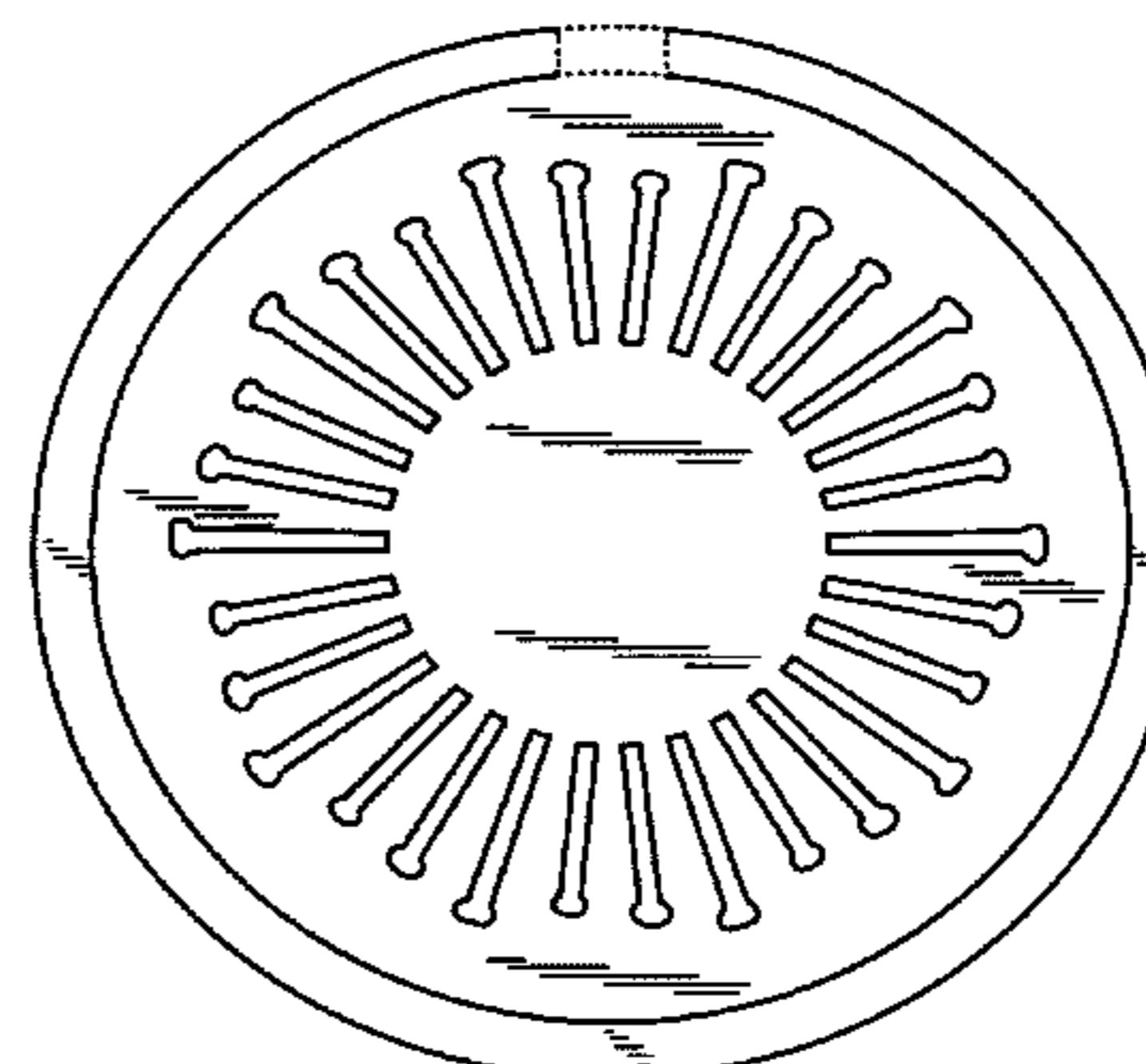
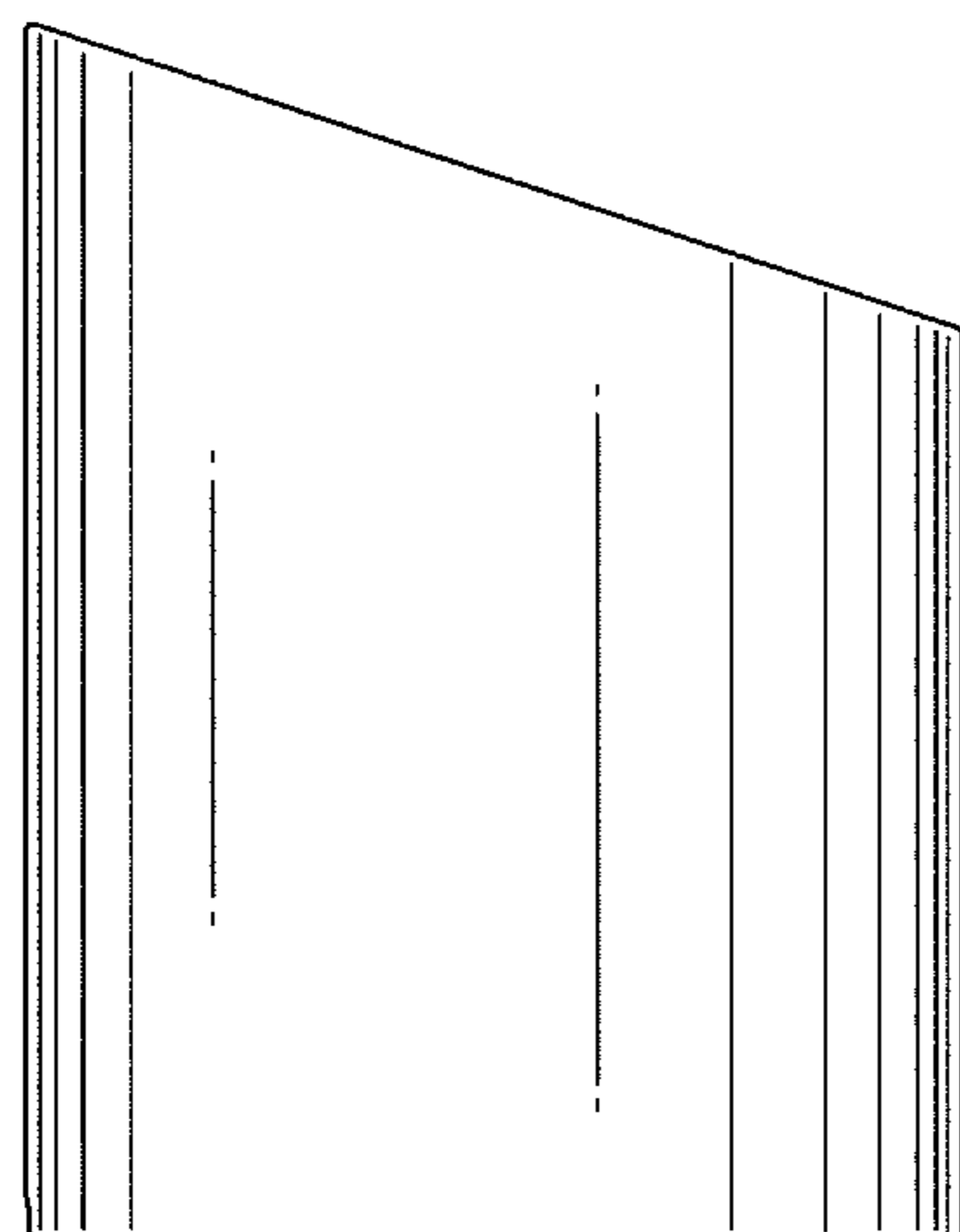

US D662,785 S

Page 2

U.S. PATENT DOCUMENTS

D334,265 S *	3/1993	Giugiaro	D32/55	D543,790 S *	6/2007	Szymanski	D7/607
D497,777 S *	11/2004	Sanders et al.	D7/603	D579,616 S	10/2008	Li	
D506,644 S *	6/2005	Poupel et al.	D7/603	D621,223 S *	8/2010	Bas	D7/603

* cited by examiner

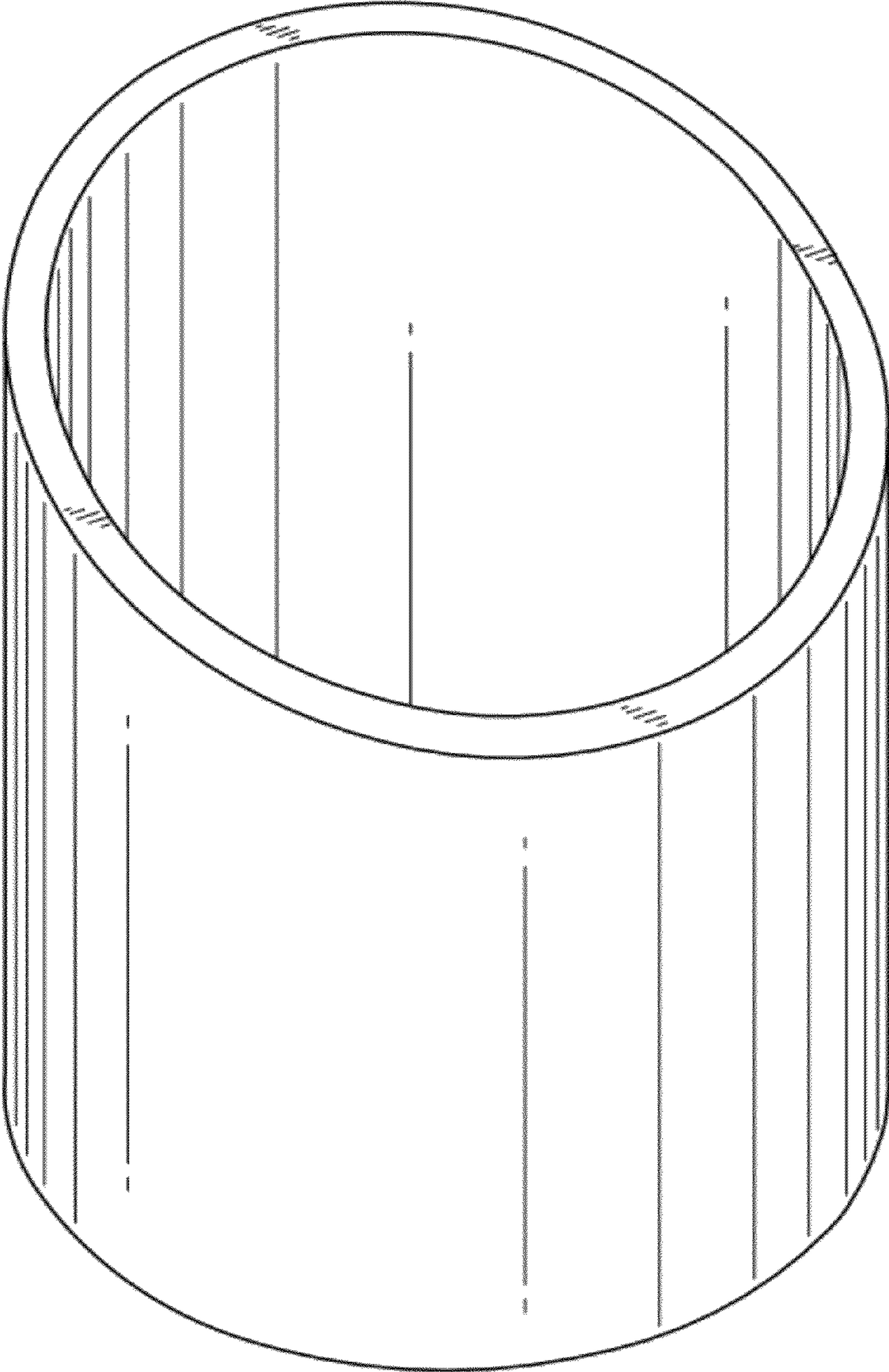

FIG. 1

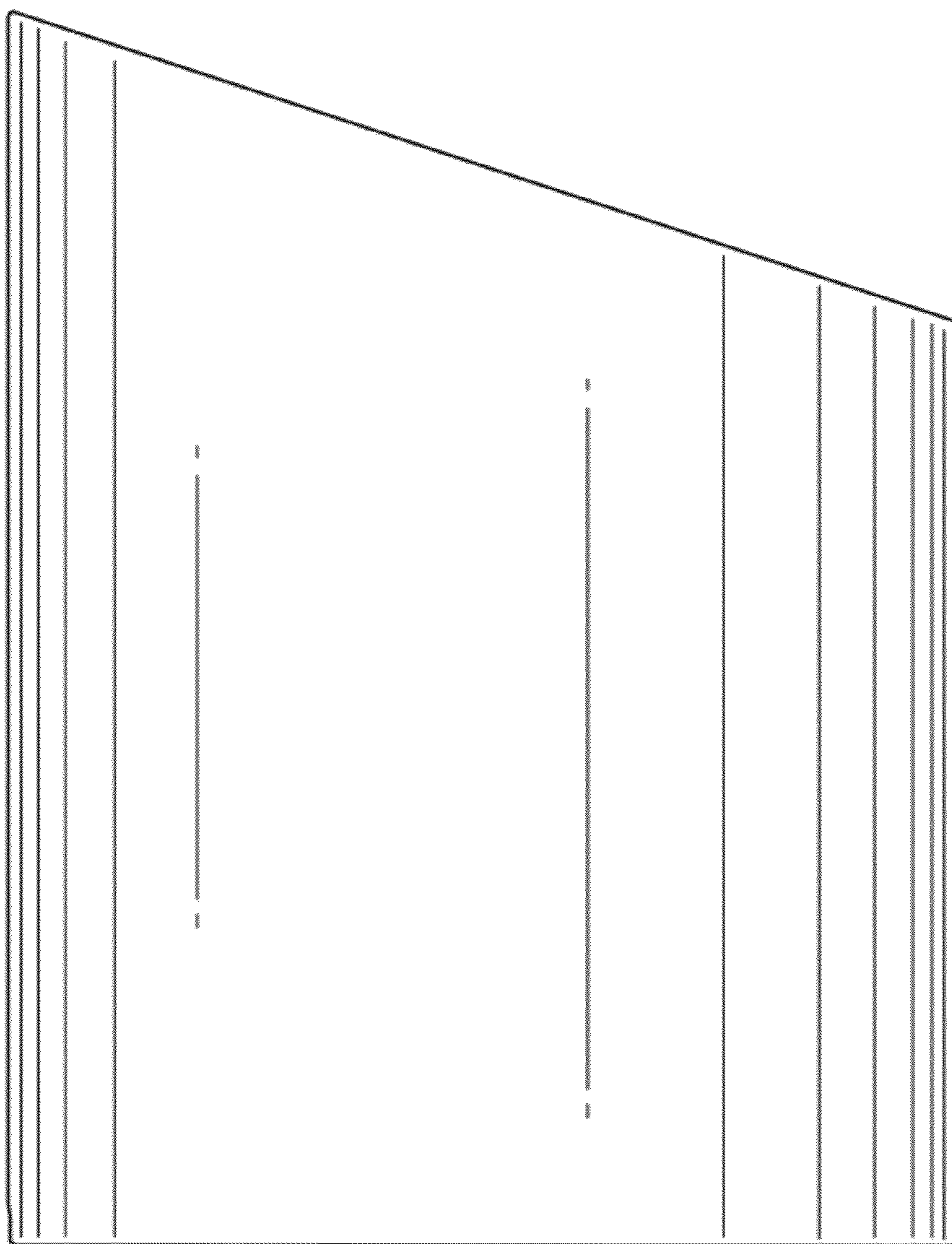

FIG. 2

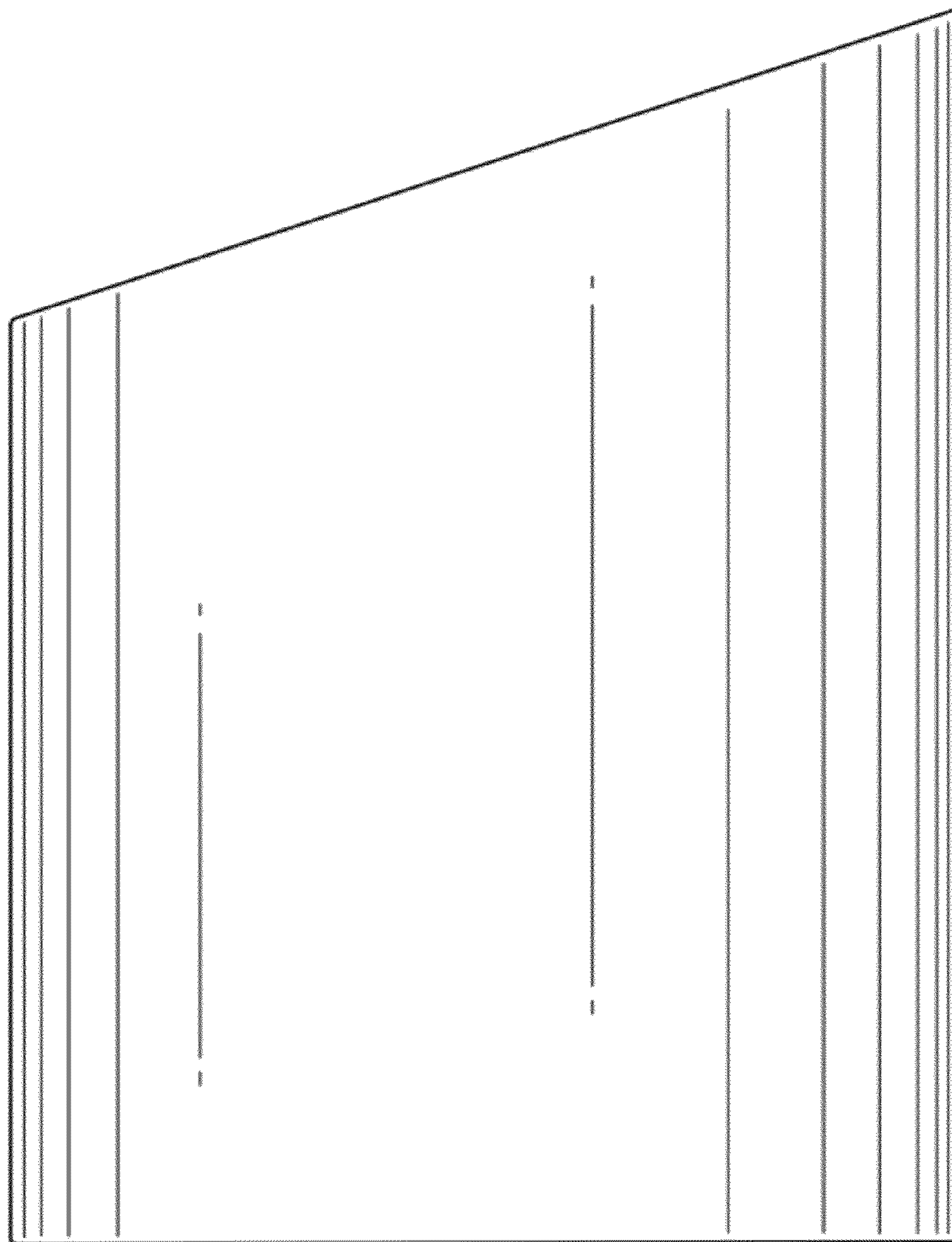

FIG. 3

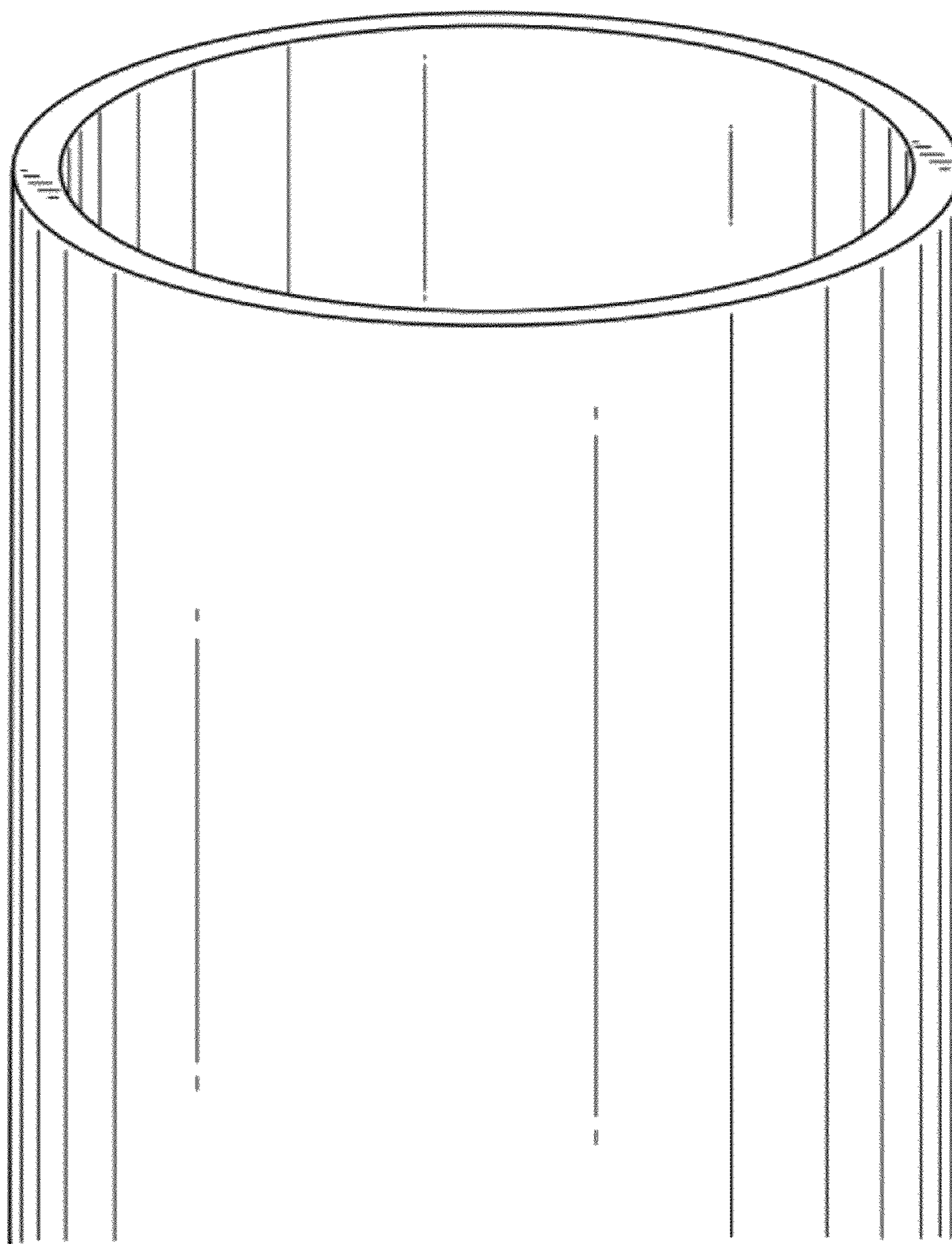

FIG. 4

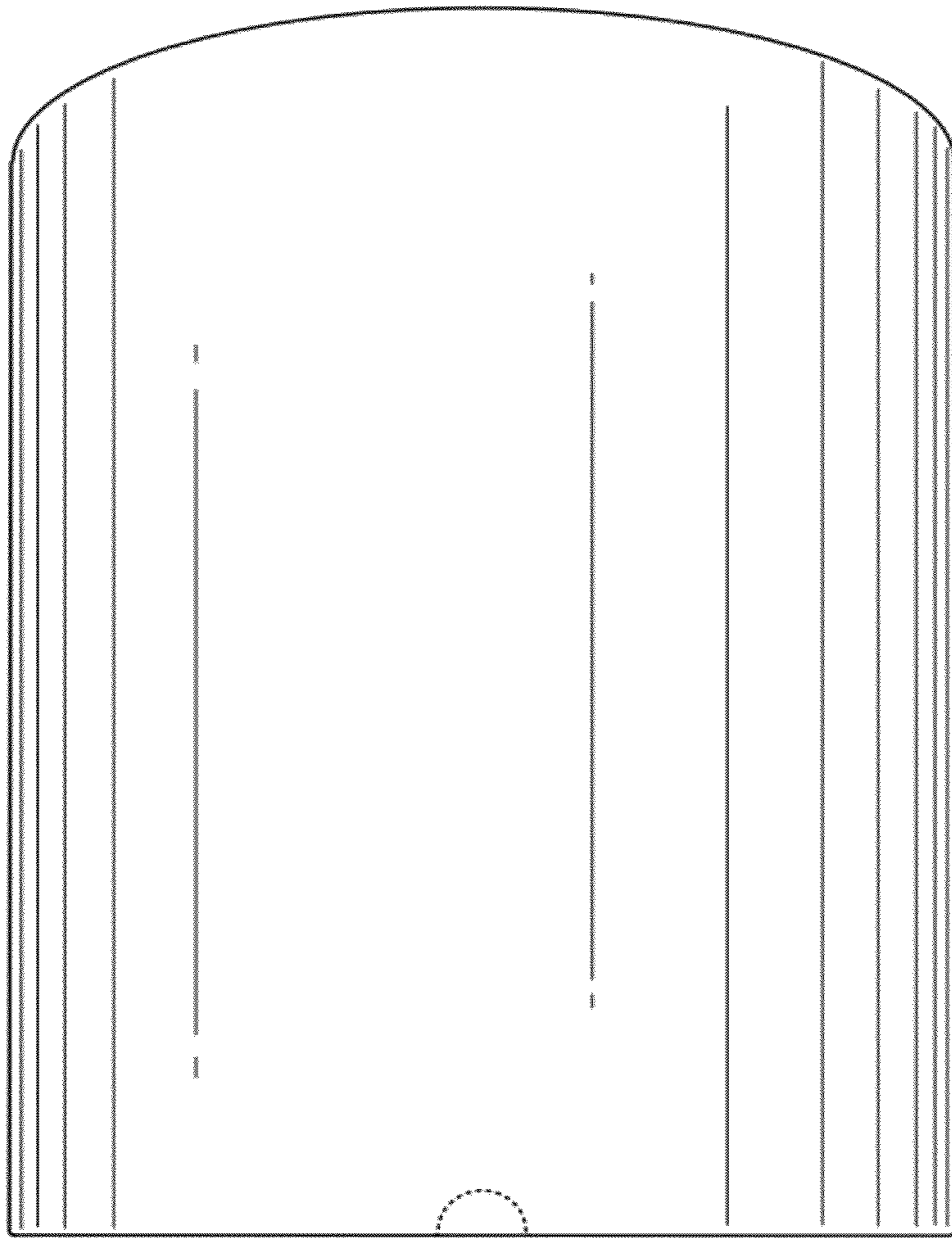

FIG. 5

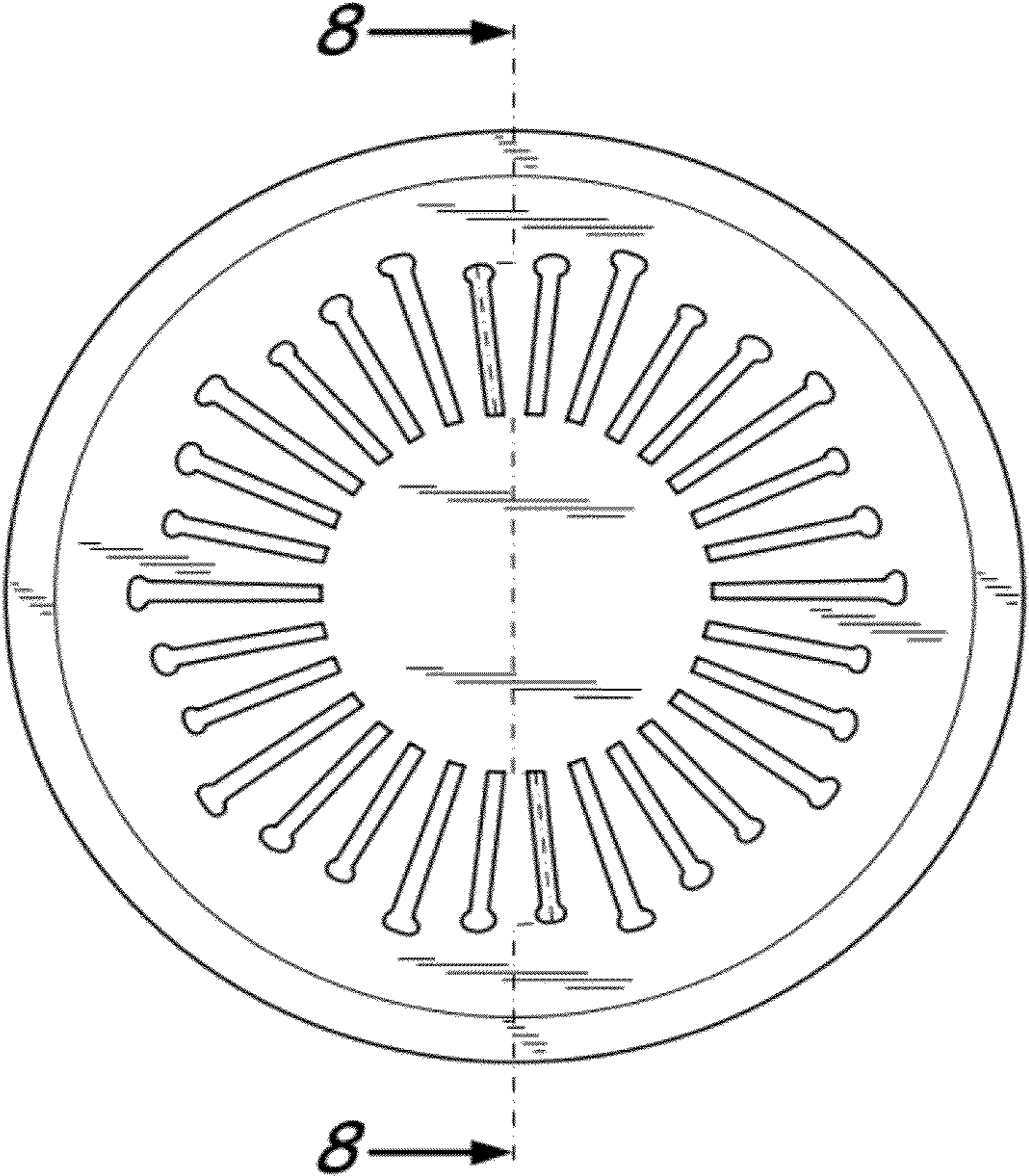

FIG. 6

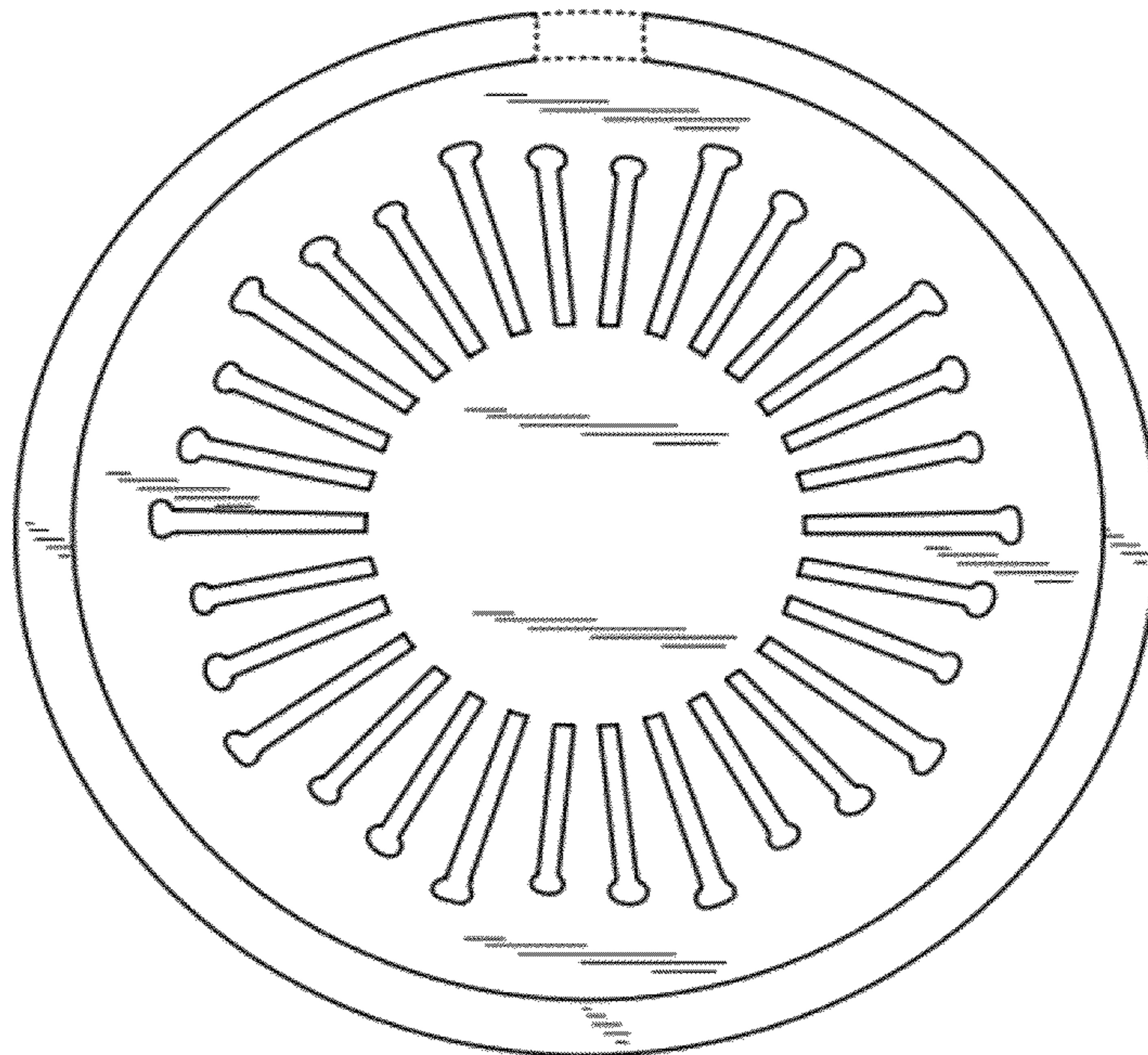

FIG. 7

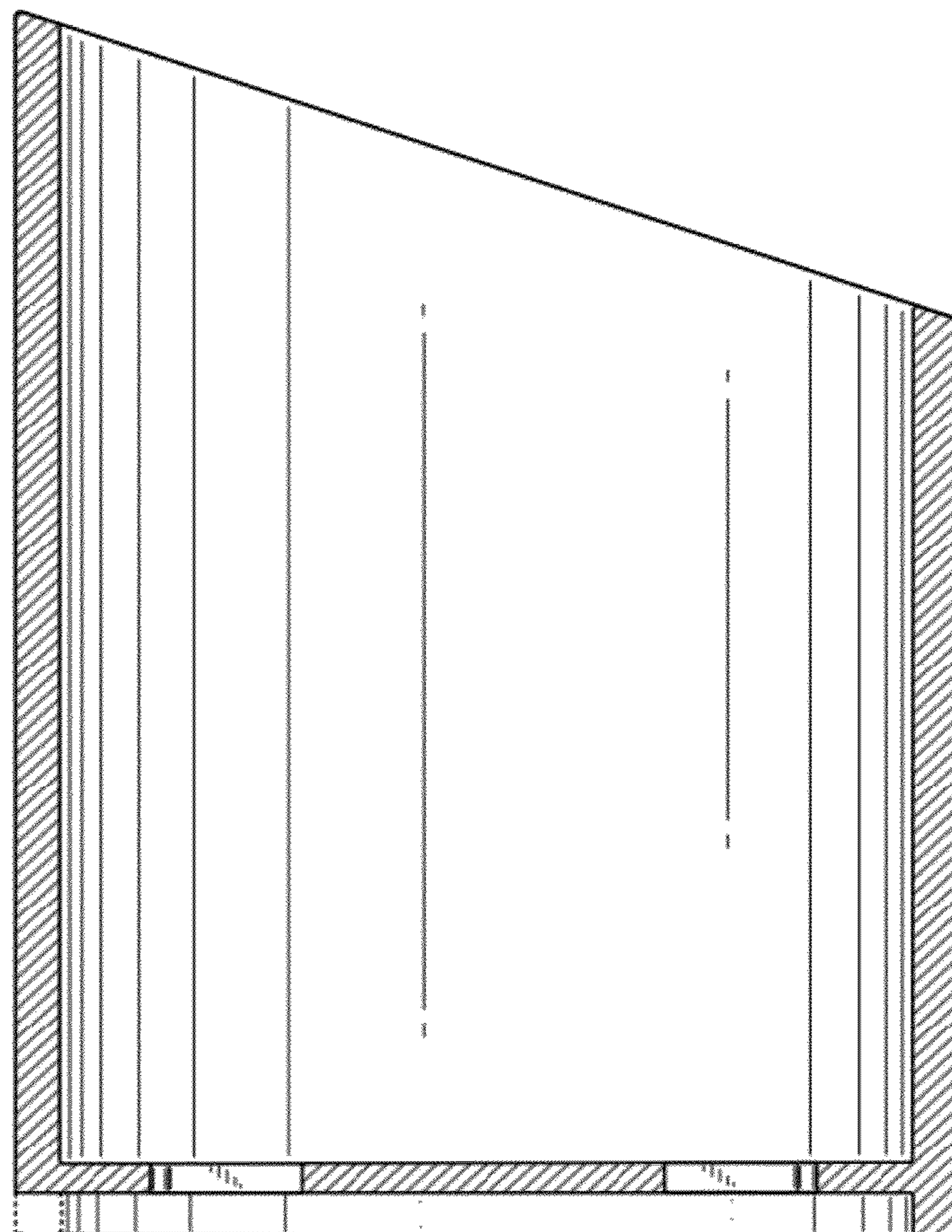

FIG. 8

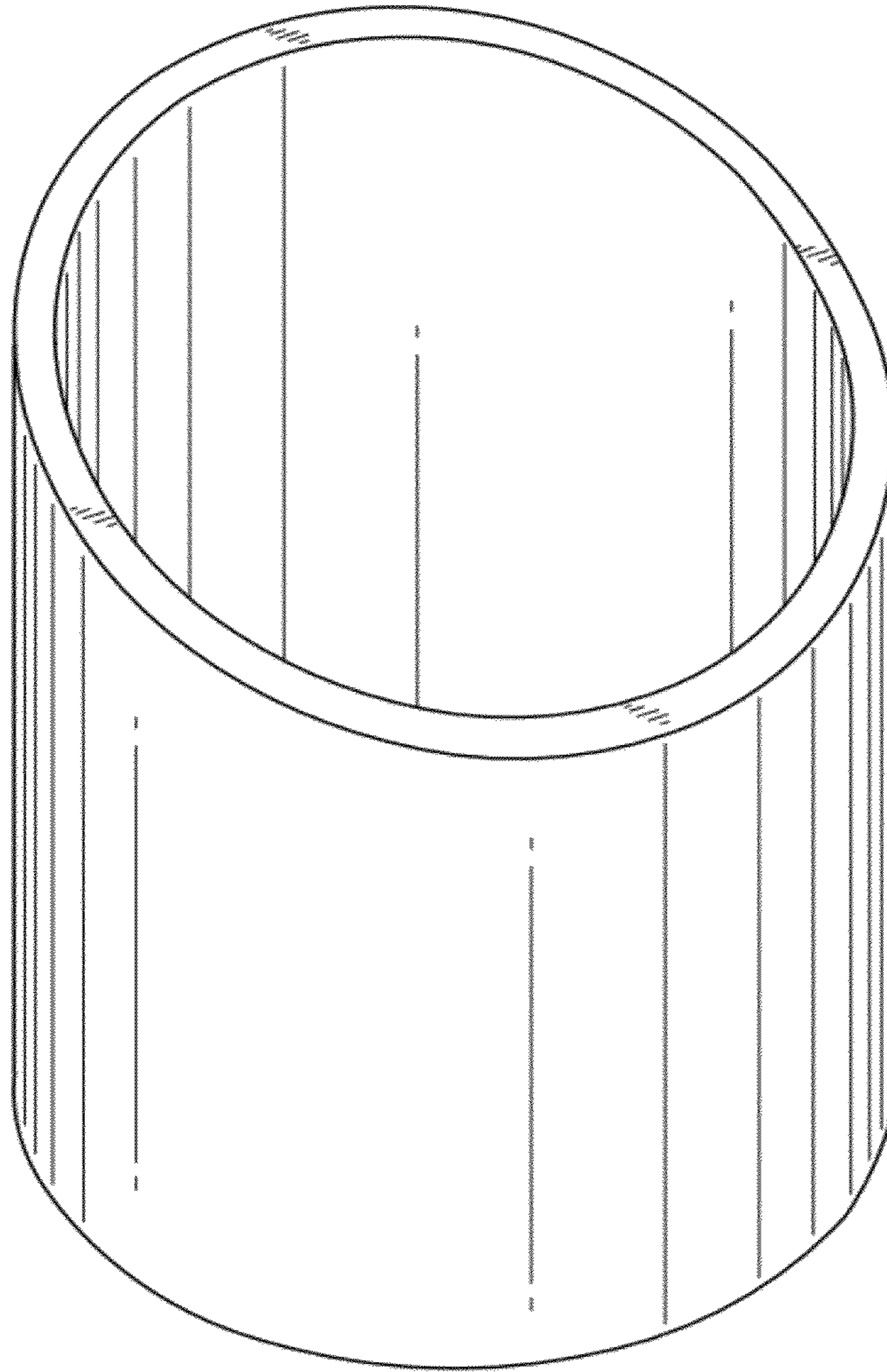

FIG. 9

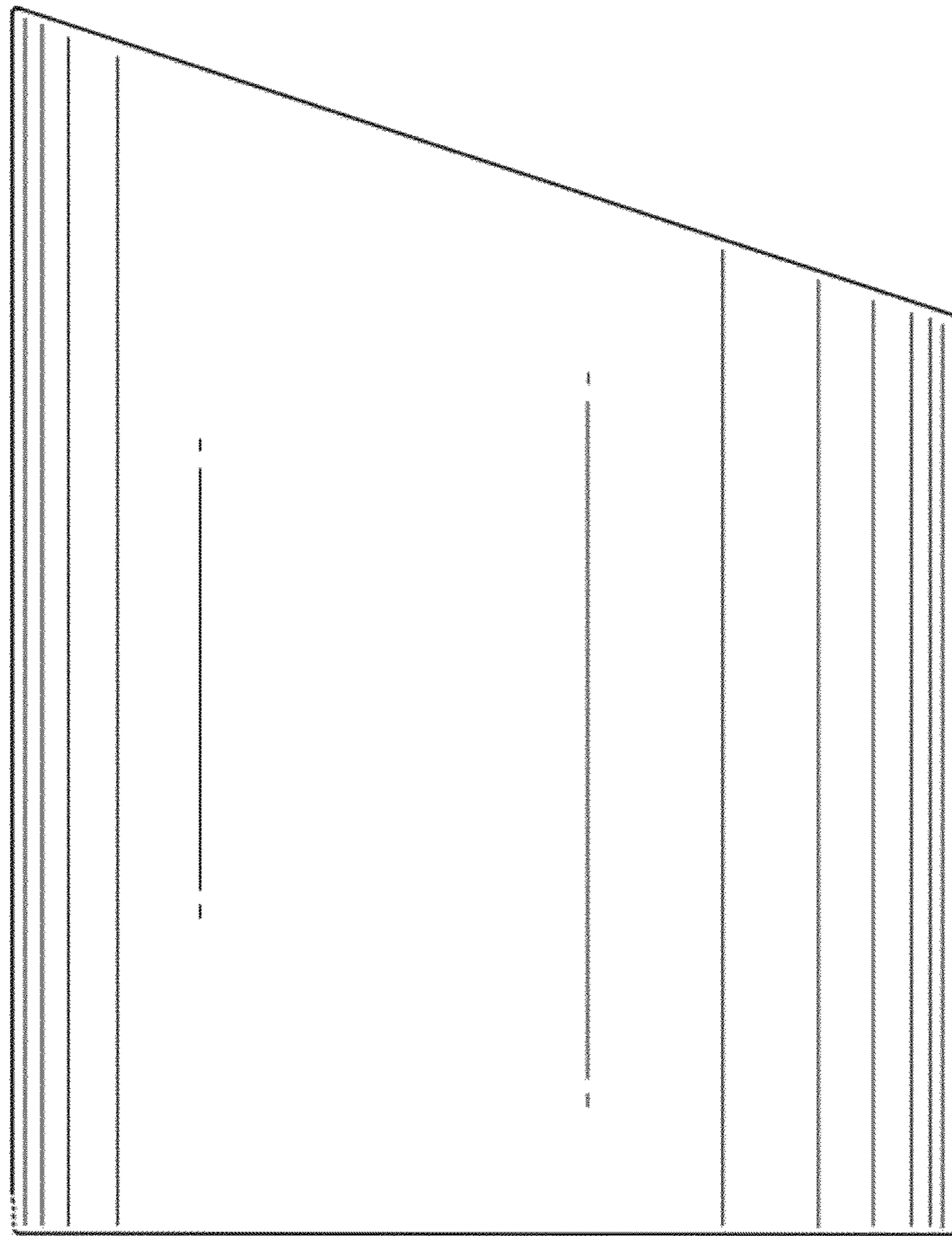

FIG. 10

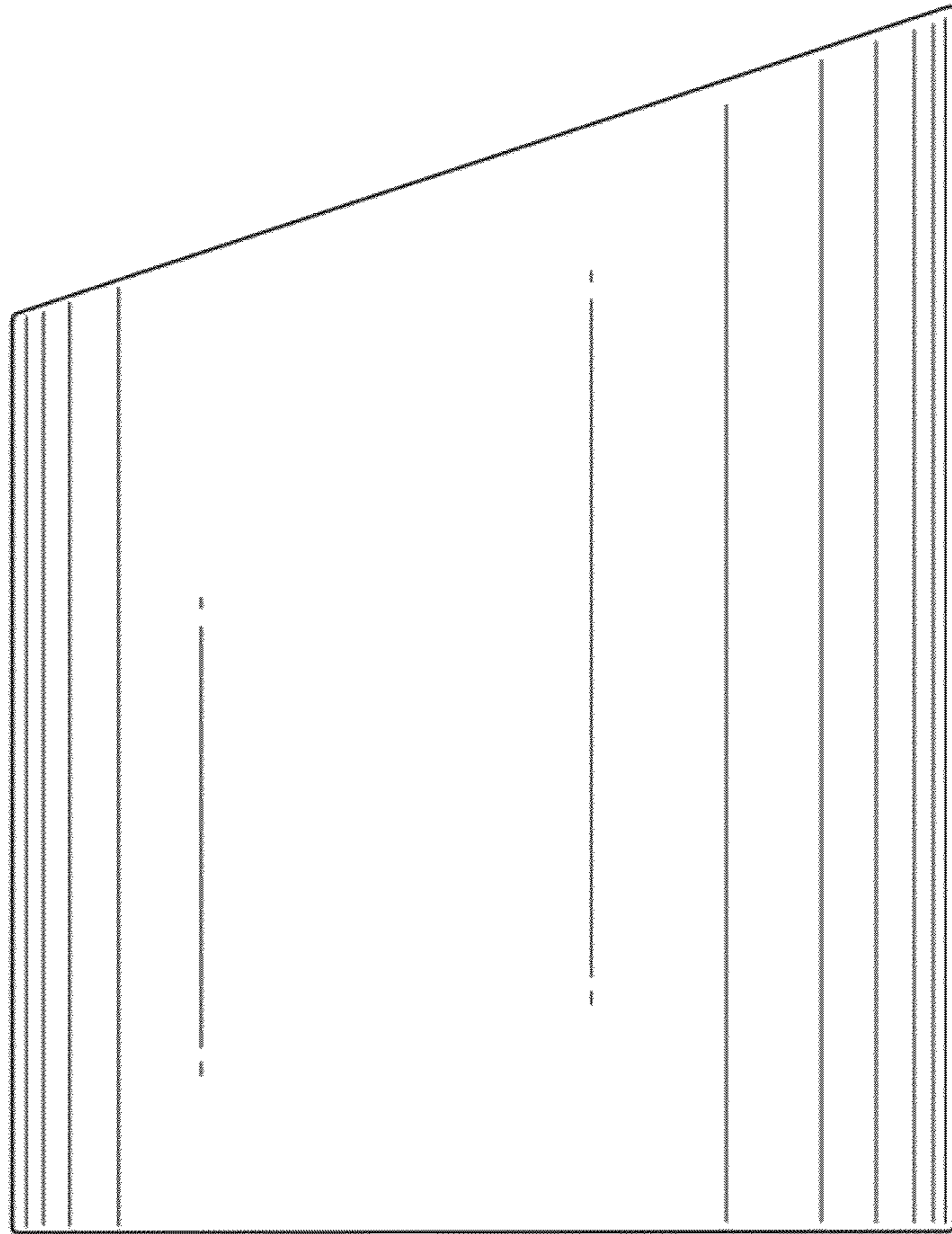

FIG. 11

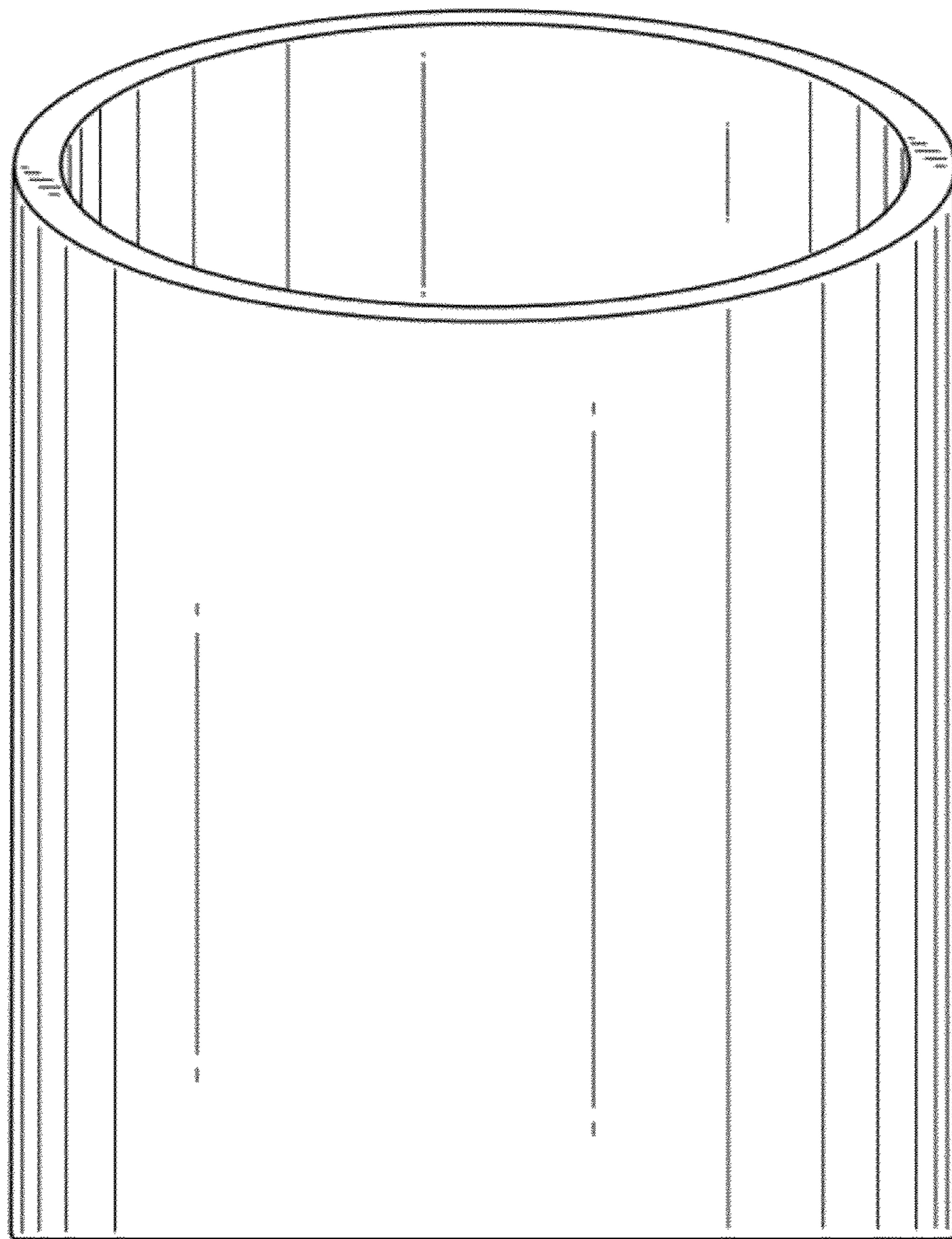

FIG. 12

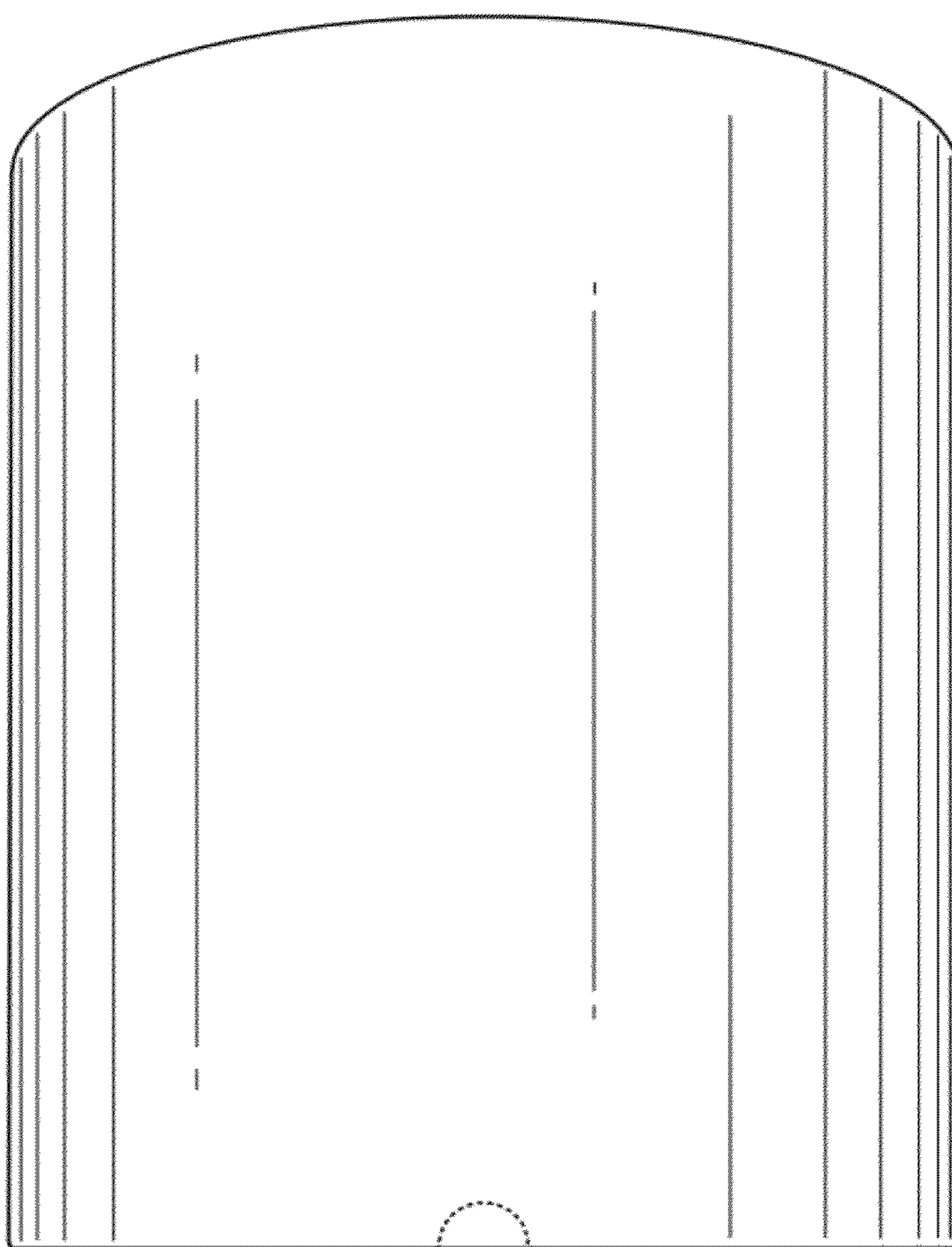

FIG. 13

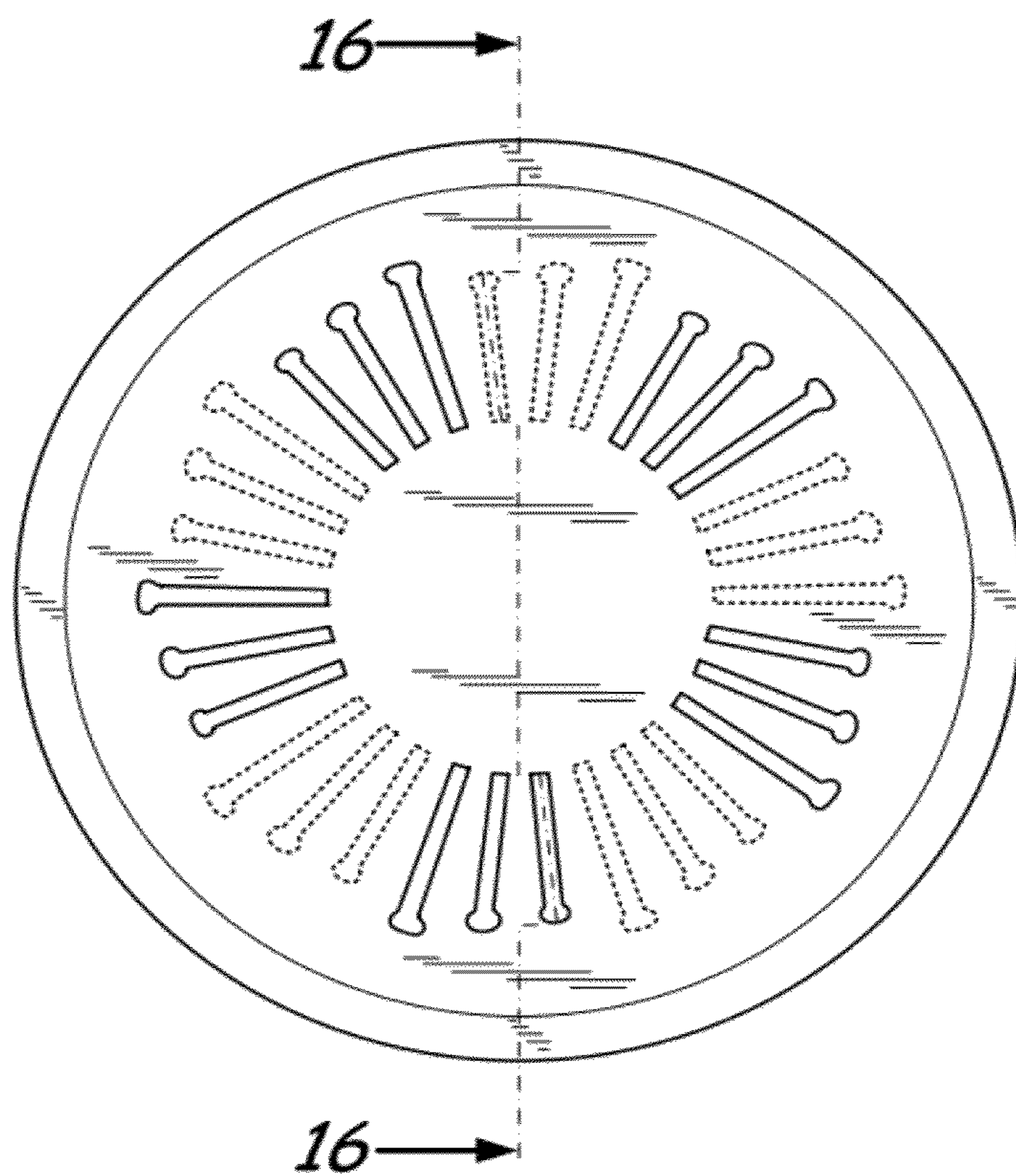

FIG. 14

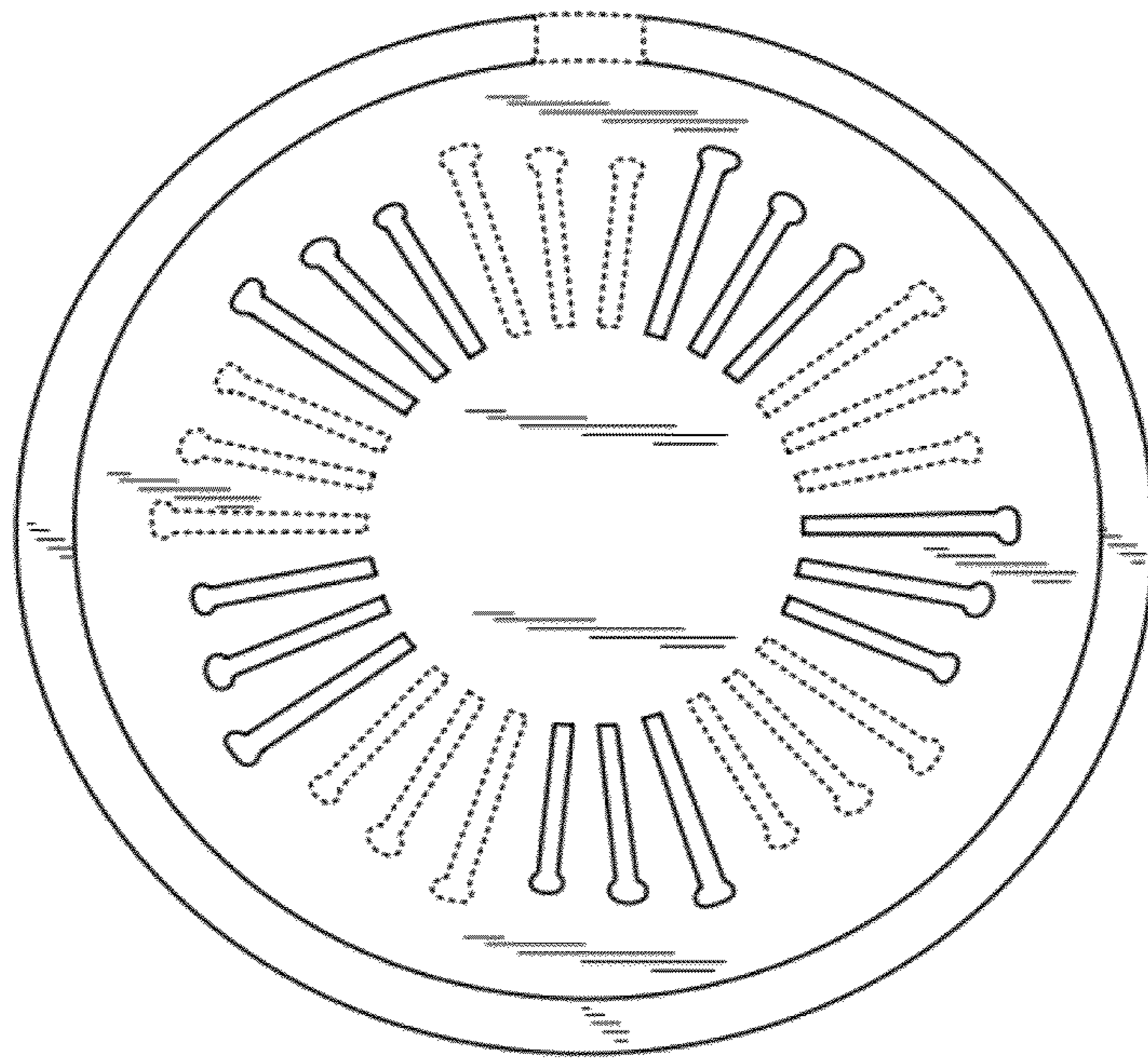

FIG. 15

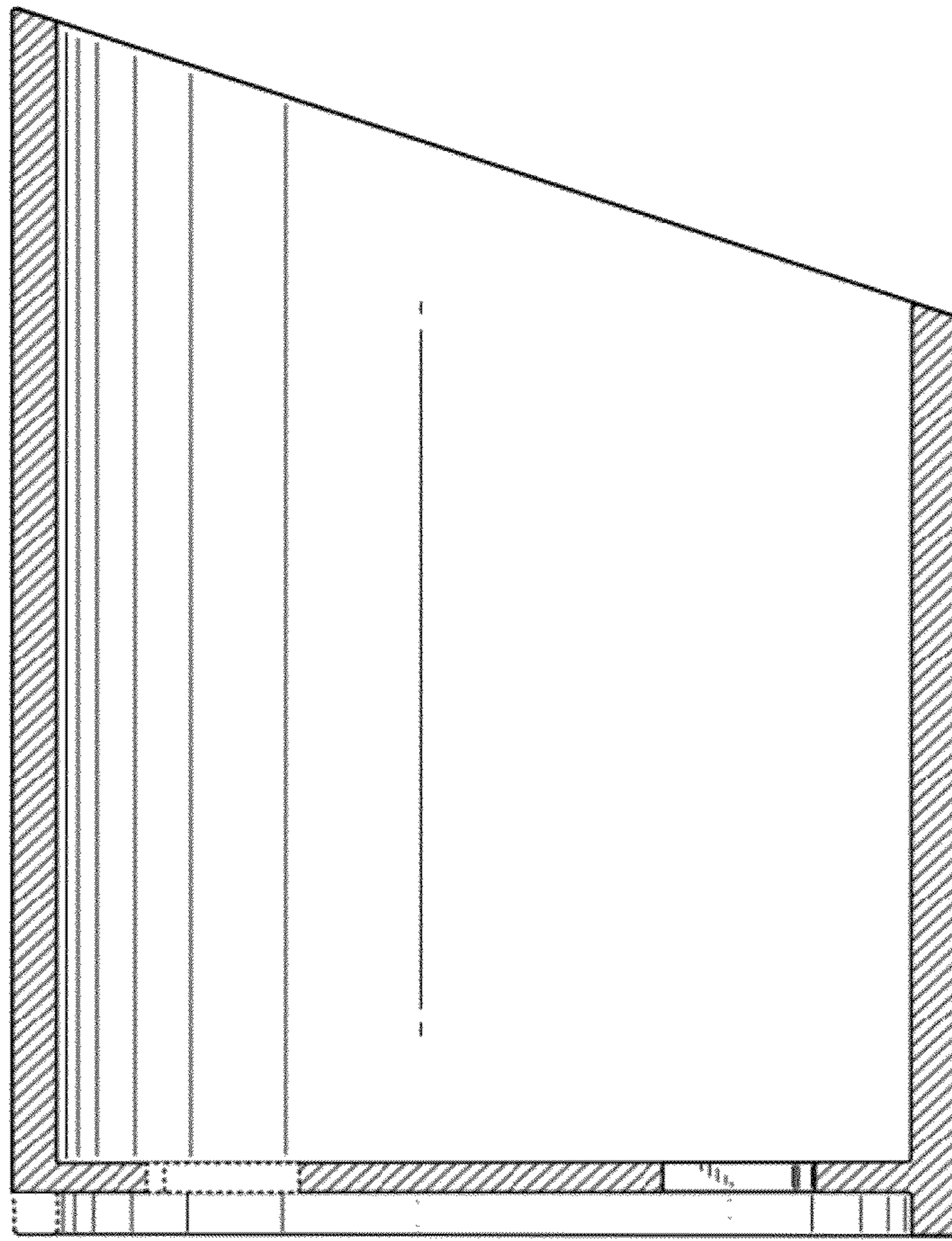

FIG. 16