

US00D662757S

(12) **United States Design Patent**  
**Roos et al.**

(10) **Patent No.:** **US D662,757 S**  
(45) **Date of Patent:** **\*\* Jul. 3, 2012**

(54) **BEER KEG**

(75) Inventors: **Jorrit Roos**, Amsterdam (NL);  
**Jan-Willem Bouwknecht**, Leiden (NL);  
**Herman Van der Vegt**, Utrecht (NL)

(73) Assignee: **Heineken Supply Chain B.V.** (NL)

(\*\*) Term: **14 Years**

(21) Appl. No.: **29/390,638**

(22) Filed: **Apr. 27, 2011**

(30) **Foreign Application Priority Data**

Nov. 5, 2010 (WO) ..... DM/074 823

(51) **LOC (9) Cl.** ..... **07-01**

(52) **U.S. Cl.** ..... **D7/313; D7/306; D7/312; D34/39**

(58) **Field of Classification Search** ..... D7/306,  
D7/313, 300, 308, 312; 222/155; D9/633;  
D34/39; 215/384

See application file for complete search history.

(56) **References Cited**

U.S. PATENT DOCUMENTS

3,212,335 A \* 10/1965 Guiffre ..... 73/328  
4,220,048 A \* 9/1980 Grepiotis et al. .... 73/323  
D264,431 S \* 5/1982 Maeda ..... D9/502  
D264,638 S \* 5/1982 Maeda ..... D9/502

D362,990 S \* 10/1995 Losordo ..... D7/305  
D374,959 S \* 10/1996 Mull ..... D34/39  
D486,347 S \* 2/2004 Meike et al. .... D7/313  
D526,827 S \* 8/2006 Allen et al. .... D7/306  
D529,749 S \* 10/2006 Allen et al. .... D7/306  
D555,967 S \* 11/2007 Rasmussen ..... D7/306  
D558,950 S \* 1/2008 Brans ..... D34/39  
D594,175 S \* 6/2009 Rasmussen ..... D34/39  
D595,474 S \* 6/2009 Rasmussen ..... D34/39  
D625,541 S \* 10/2010 Kauer ..... D7/300.1

\* cited by examiner

*Primary Examiner* — Marianne Pandozzi

(74) *Attorney, Agent, or Firm* — Altera Law Group, LLC

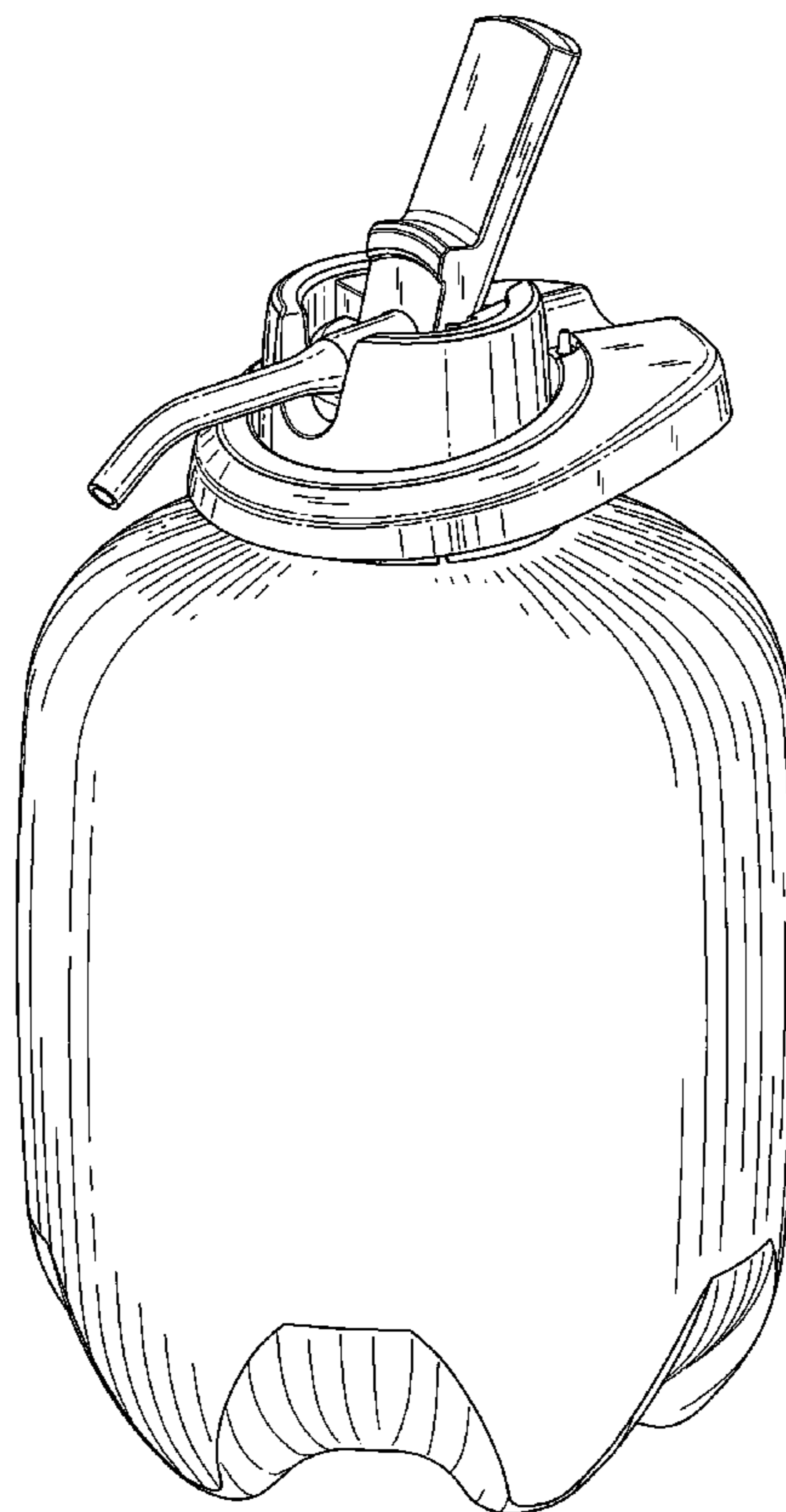
(57) **CLAIM**

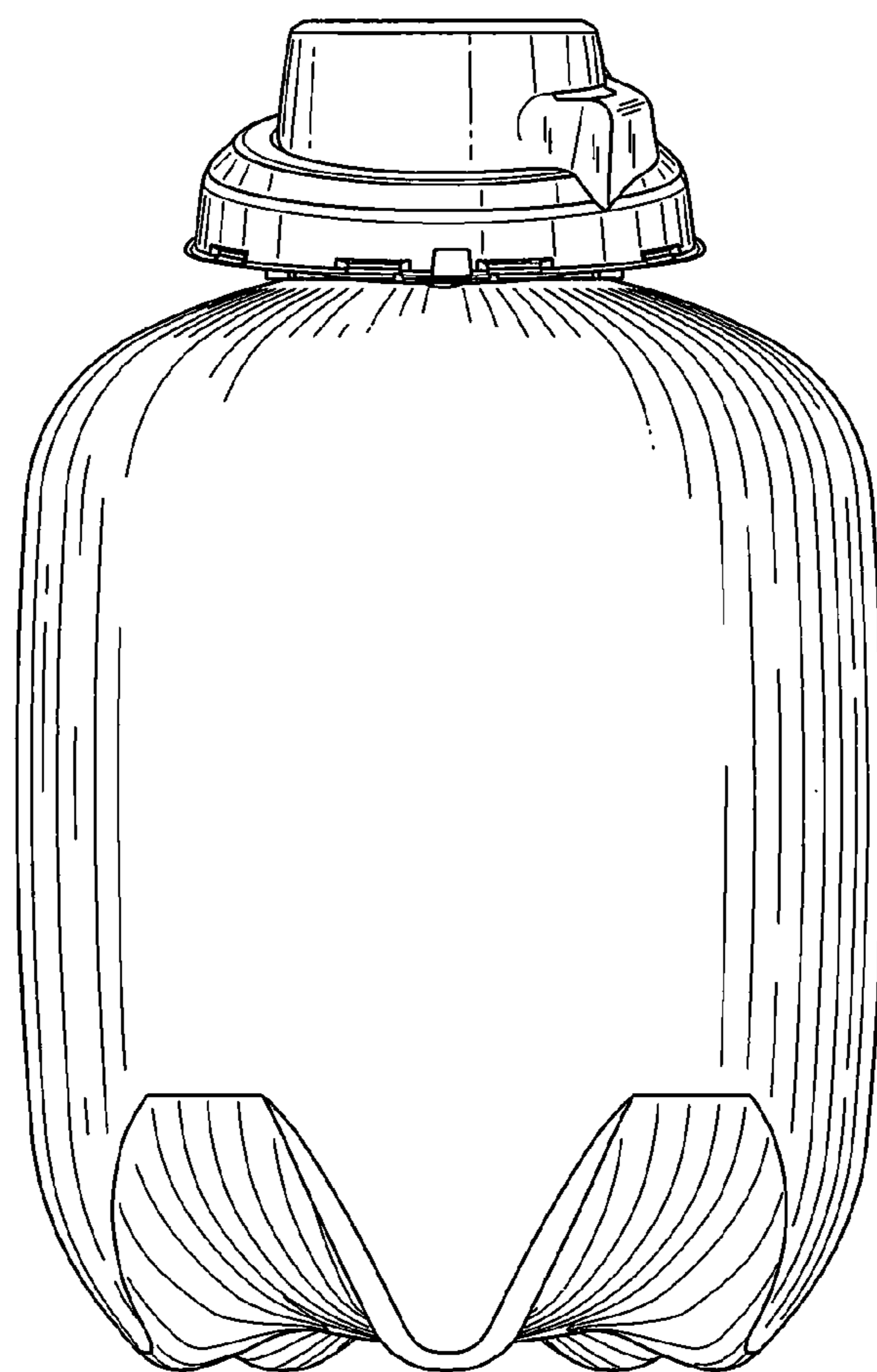
The ornamental design for a beer keg, as shown and described.

**DESCRIPTION**

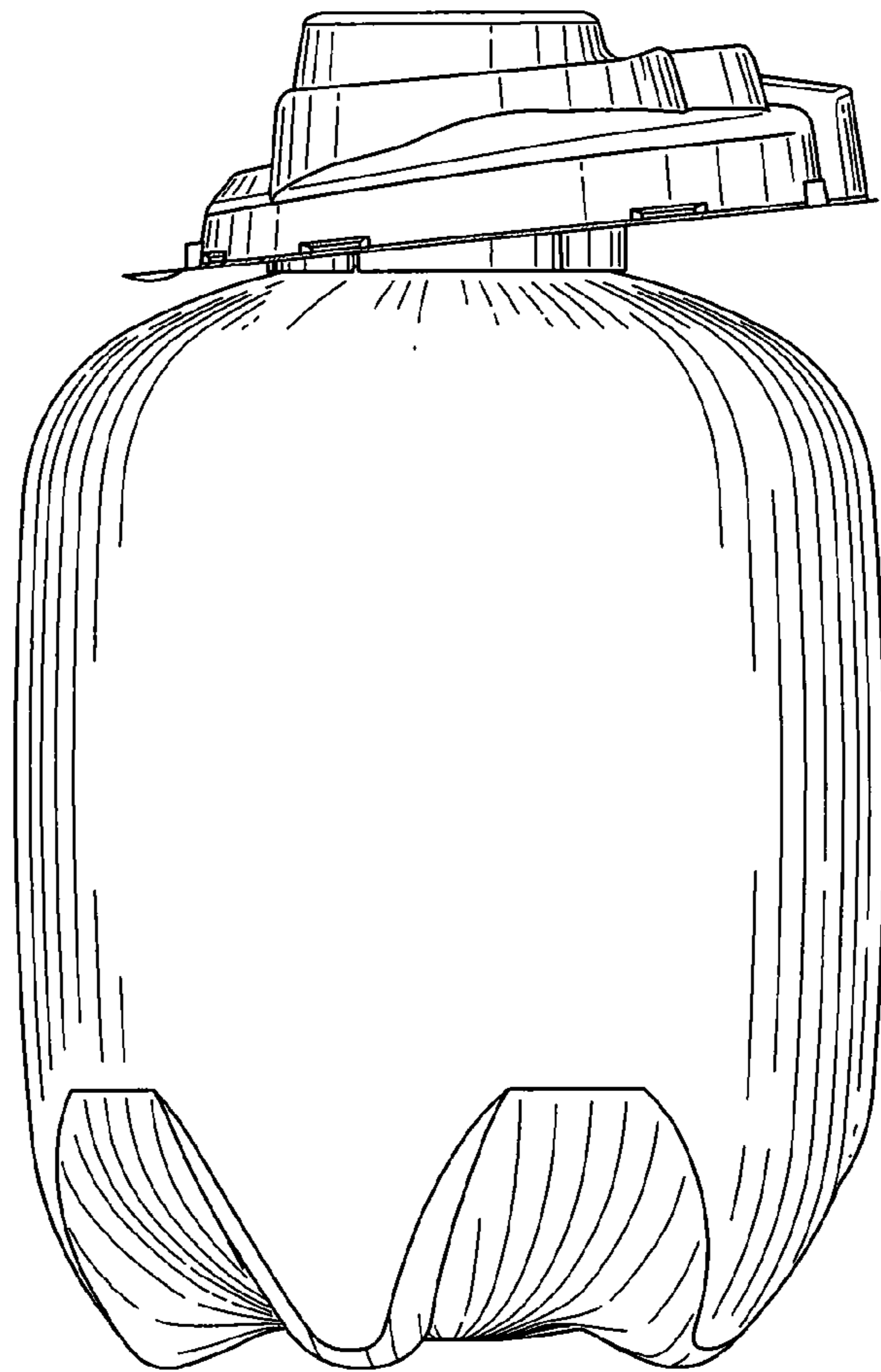
FIG. 1 is a front view of a beer keg showing our new design;  
FIG. 2 is a side view thereof;  
FIG. 3 is a rear view thereof;  
FIG. 4 is a top plan view thereof;  
FIG. 5 is a rear perspective view thereof;  
FIG. 6 is a front perspective view thereof;  
FIG. 7 is a front view of the beer keg in open position;  
FIG. 8 is a side view thereof;  
FIG. 9 is a rear view thereof;  
FIG. 10 is a top plan view thereof;  
FIG. 11 is a rear perspective view thereof; and,  
FIG. 12 is a front perspective view thereof.

**1 Claim, 12 Drawing Sheets**

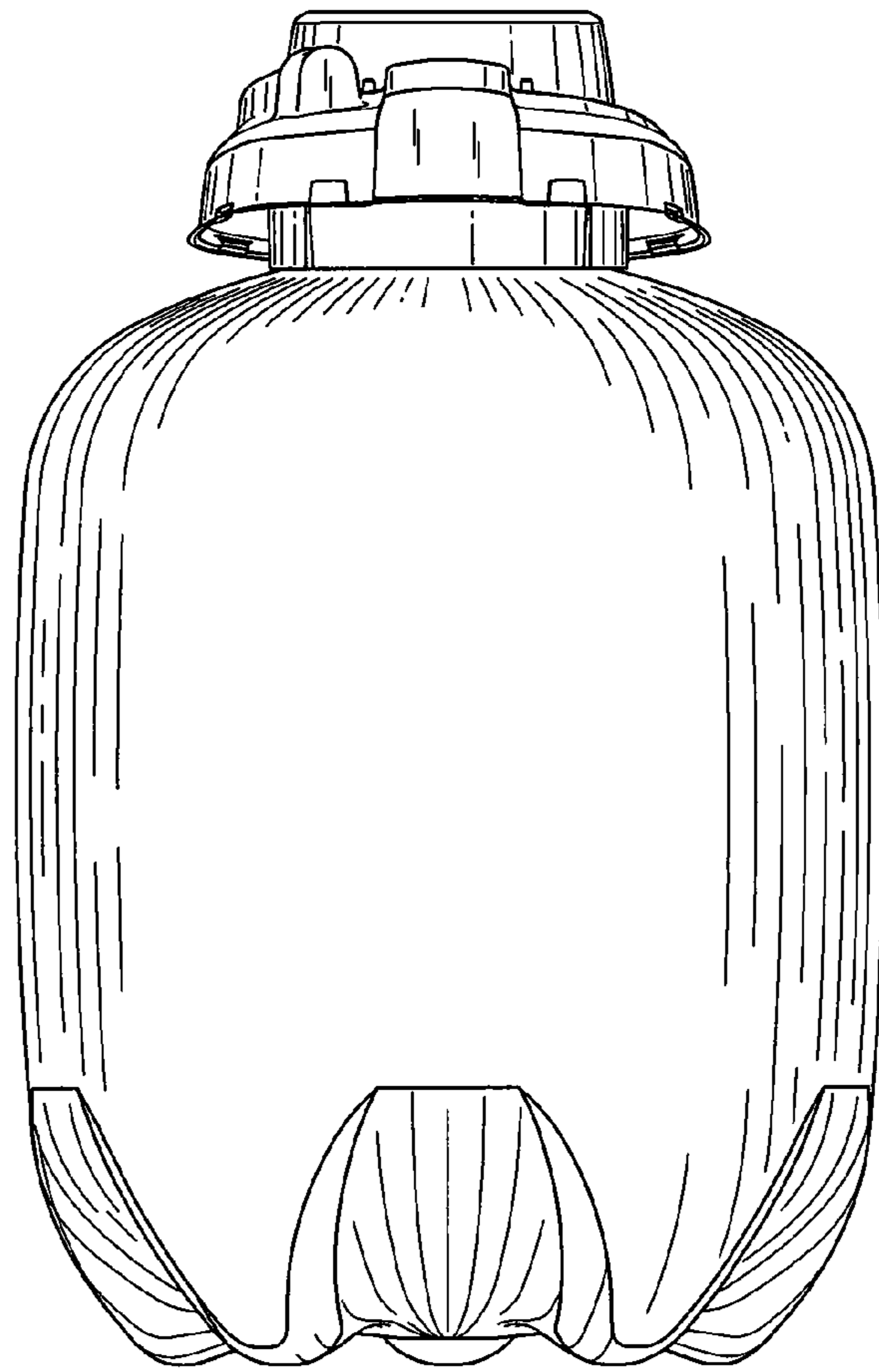




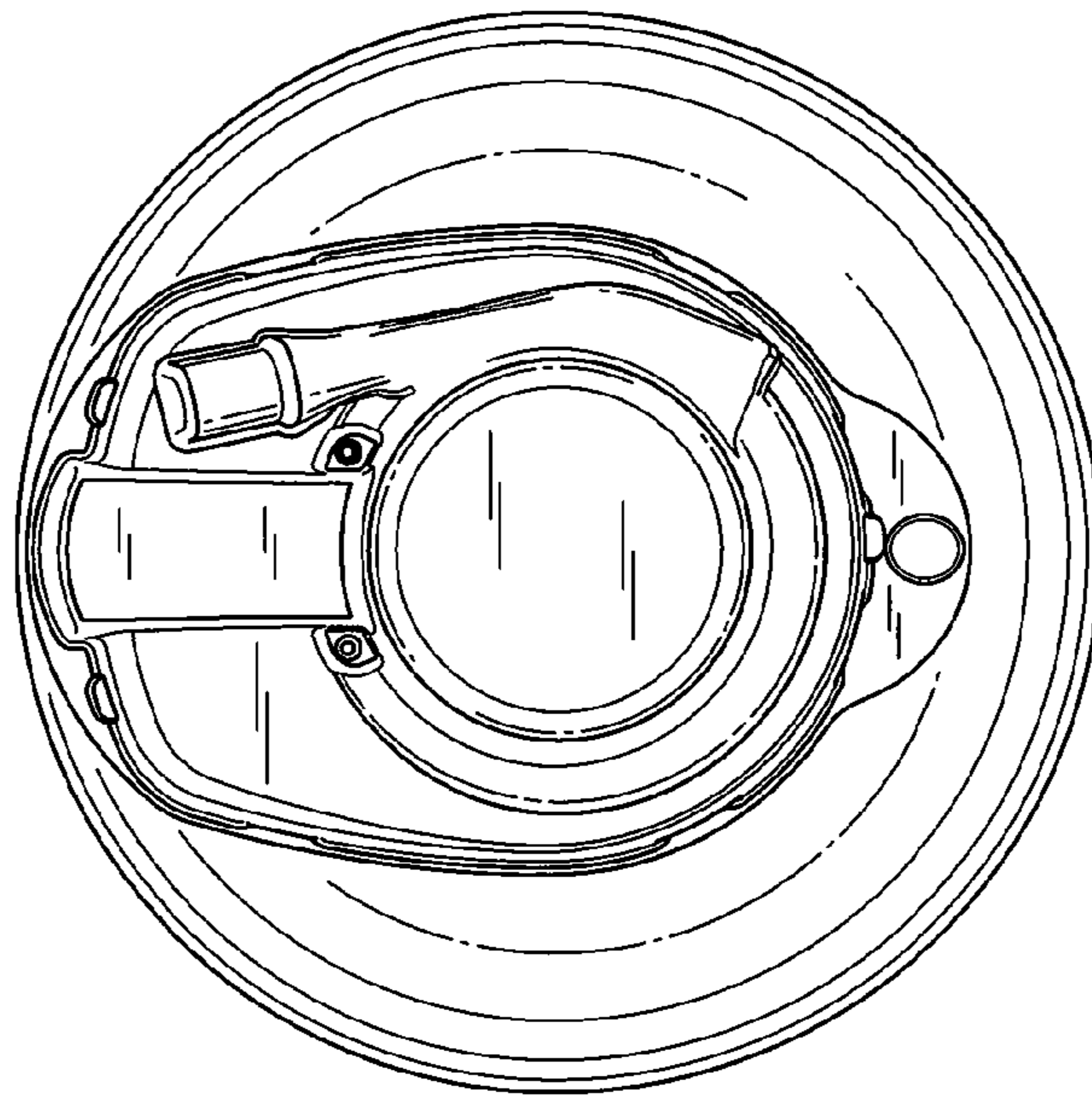
**Fig. 1**



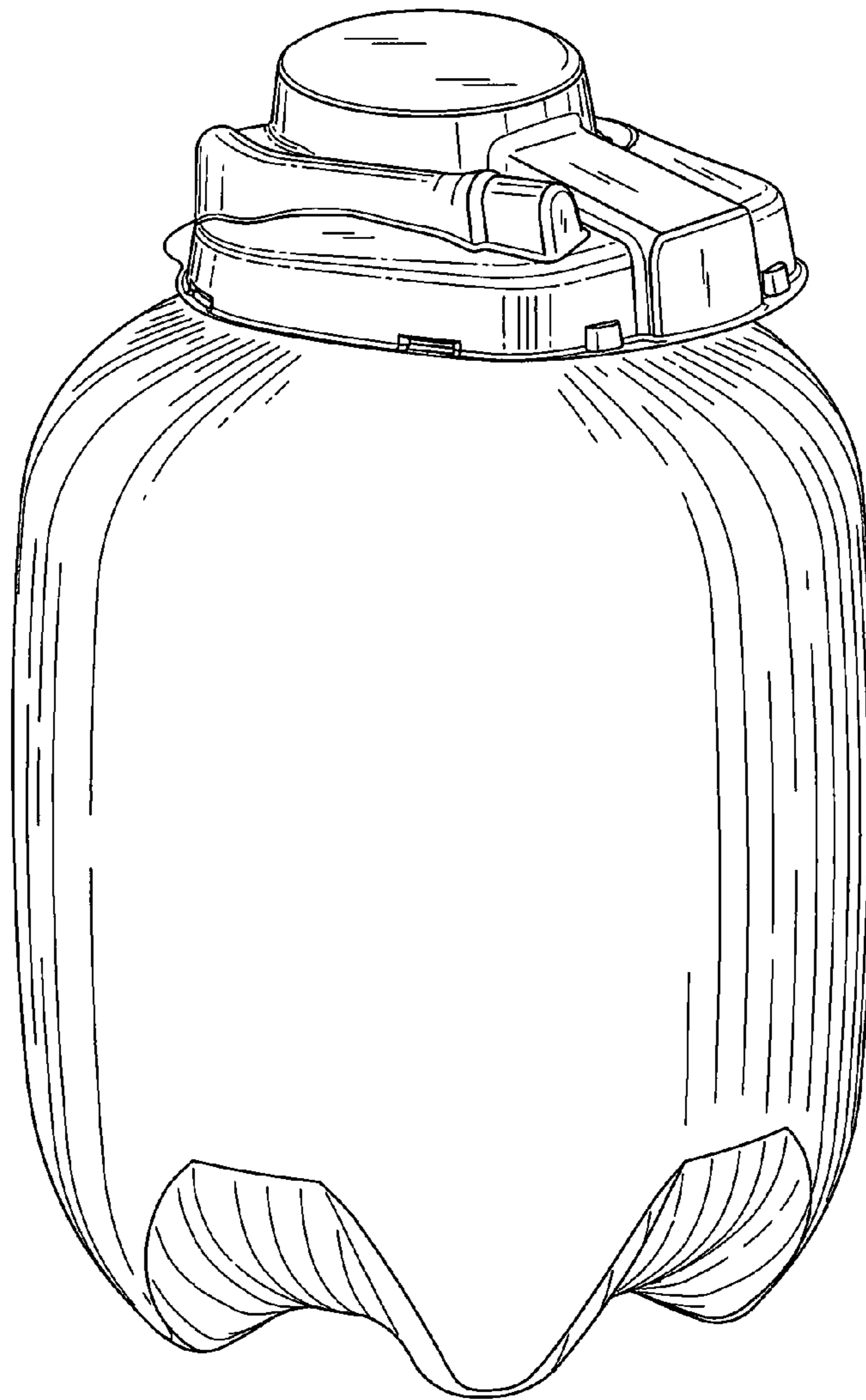
**Fig. 2**



**Fig. 3**

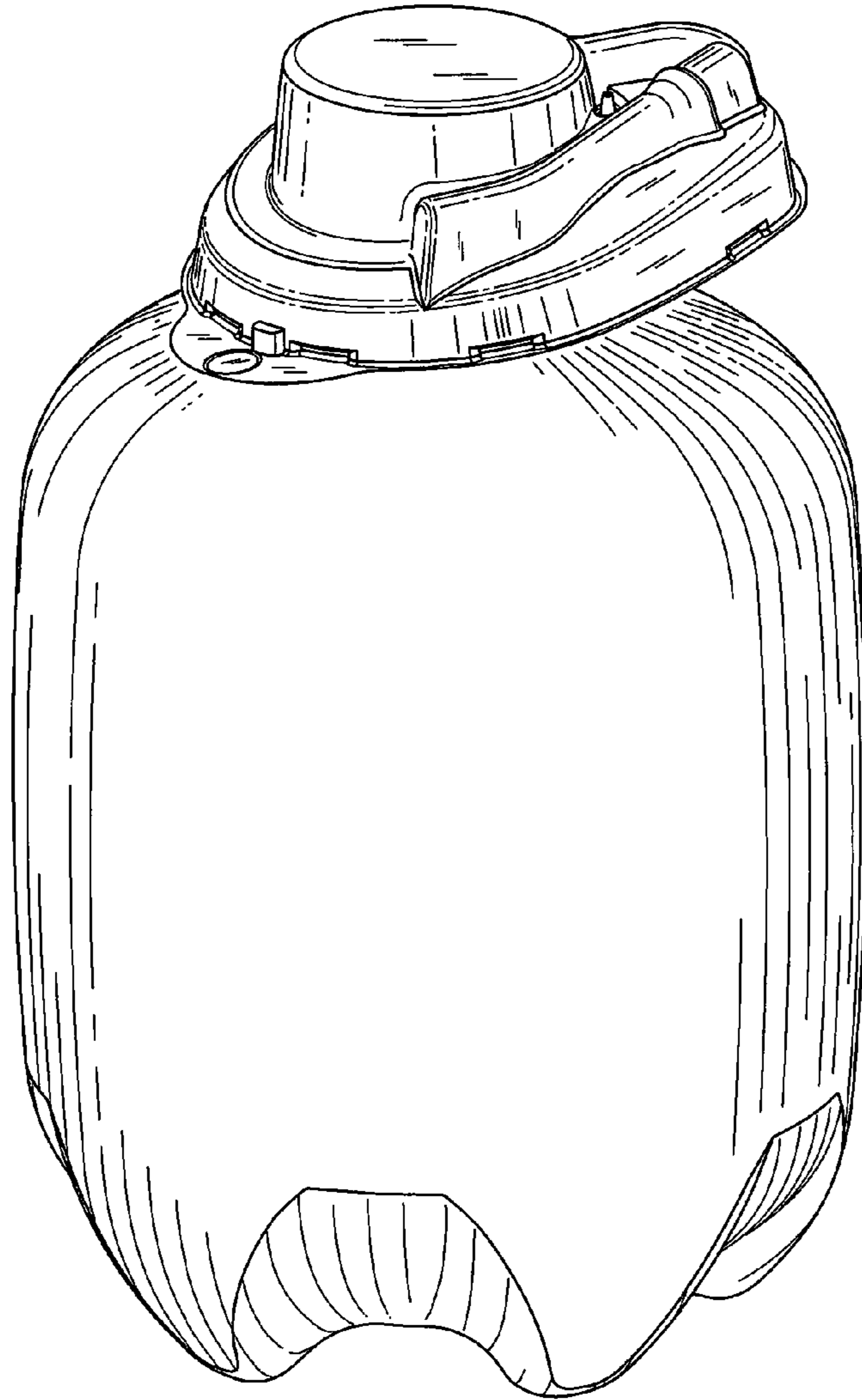


**Fig. 4**

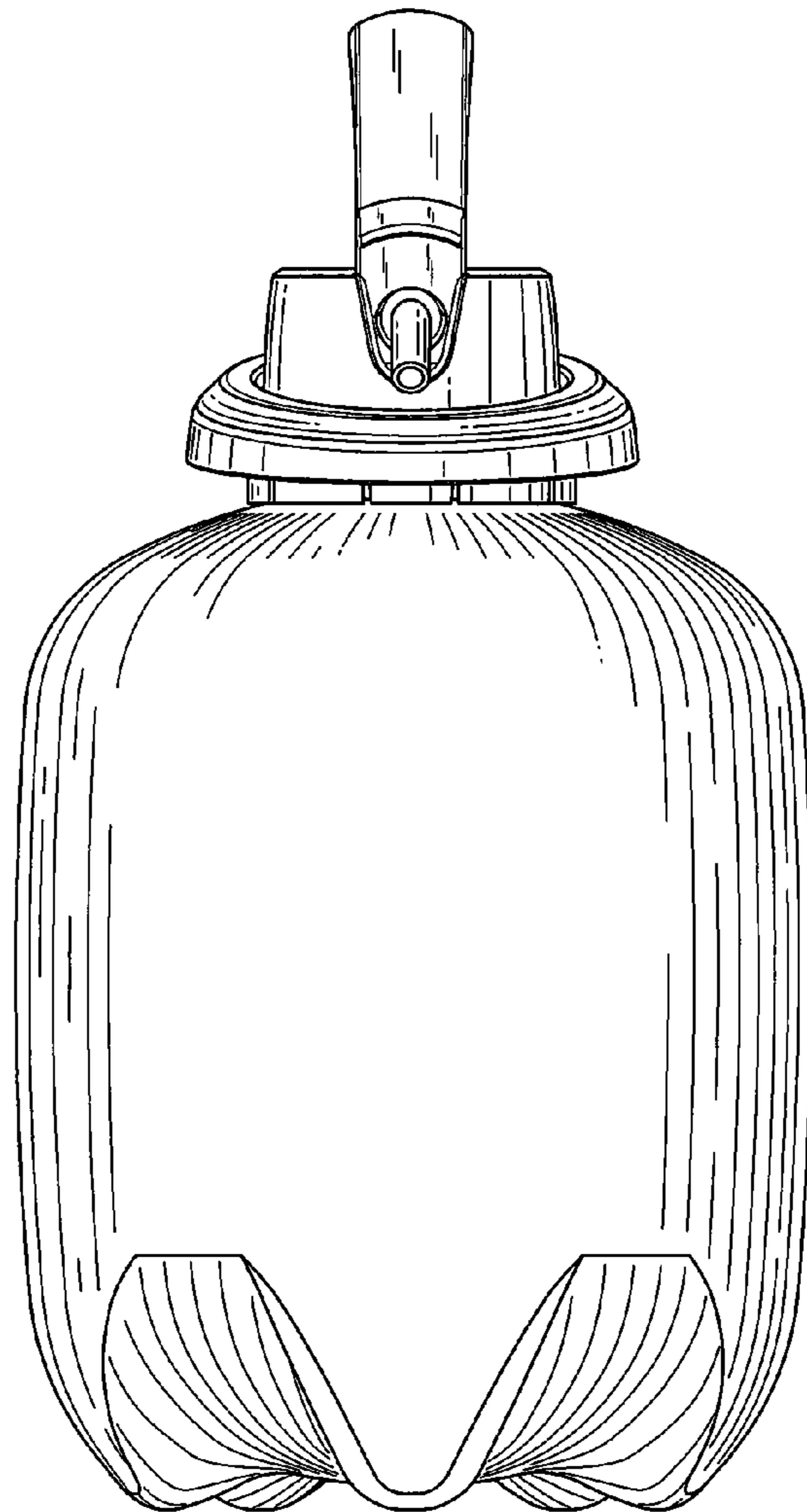


**Fig. 5**





**Fig. 6**



**Fig. 7**



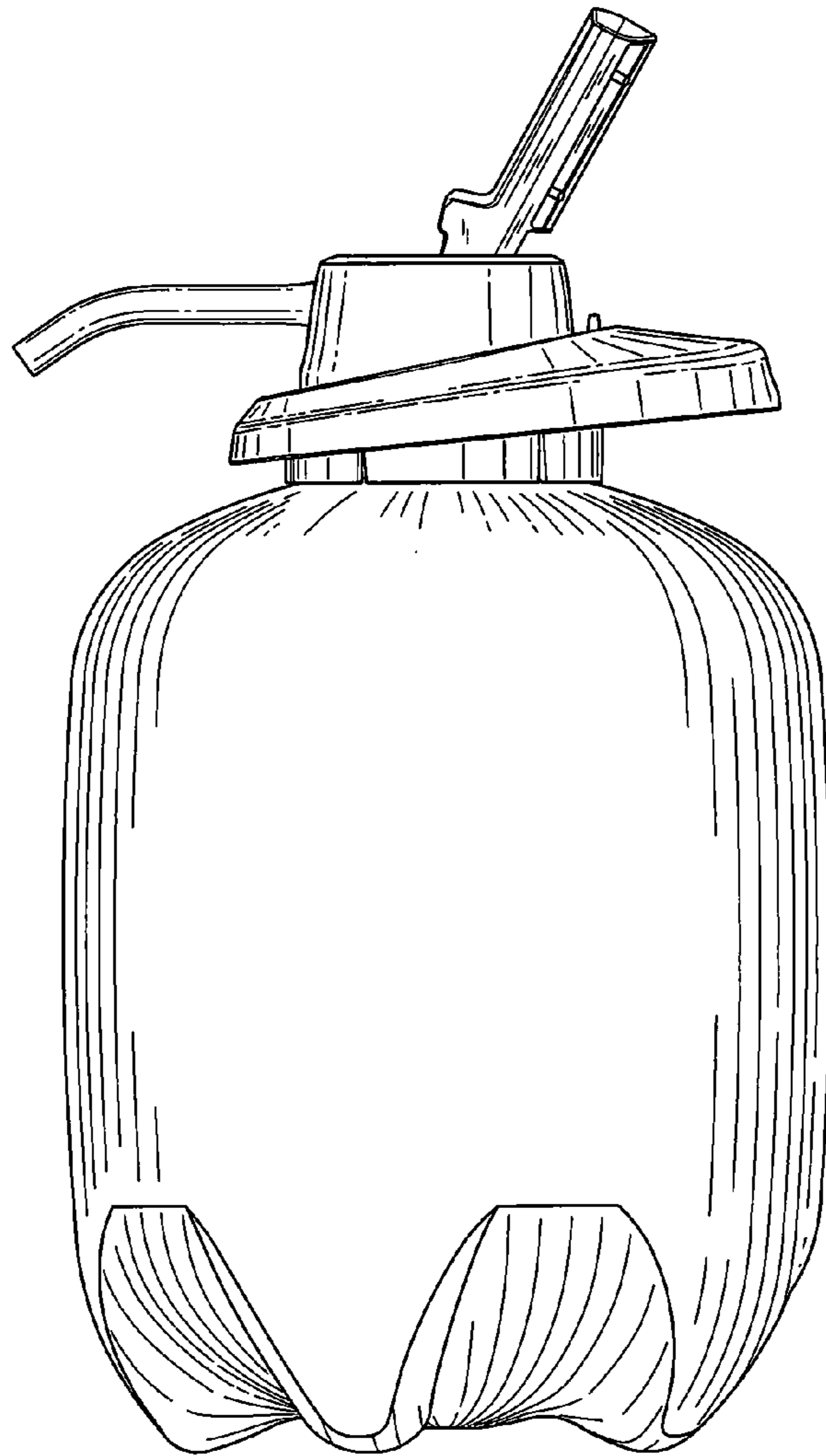


Fig. 8

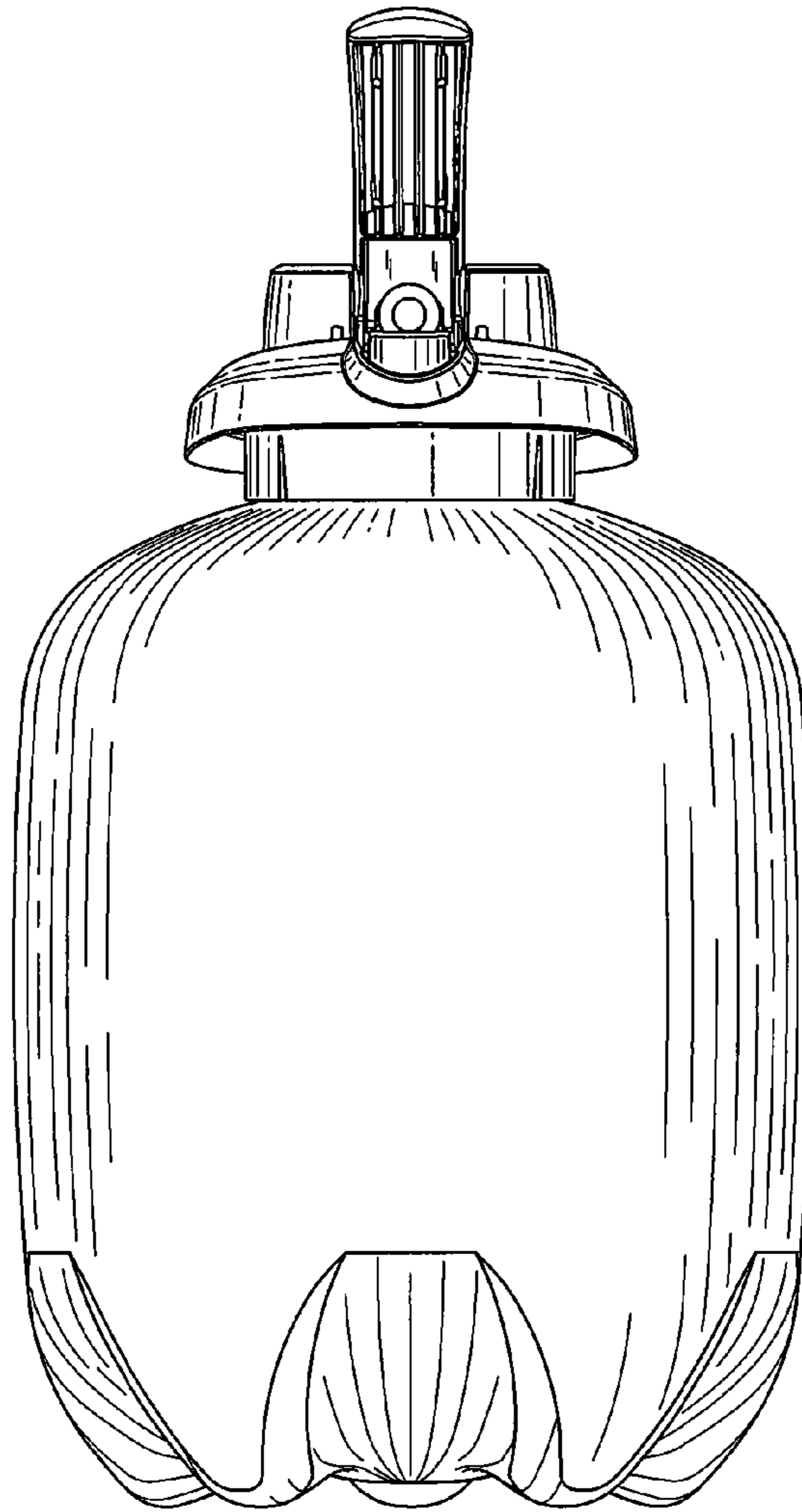
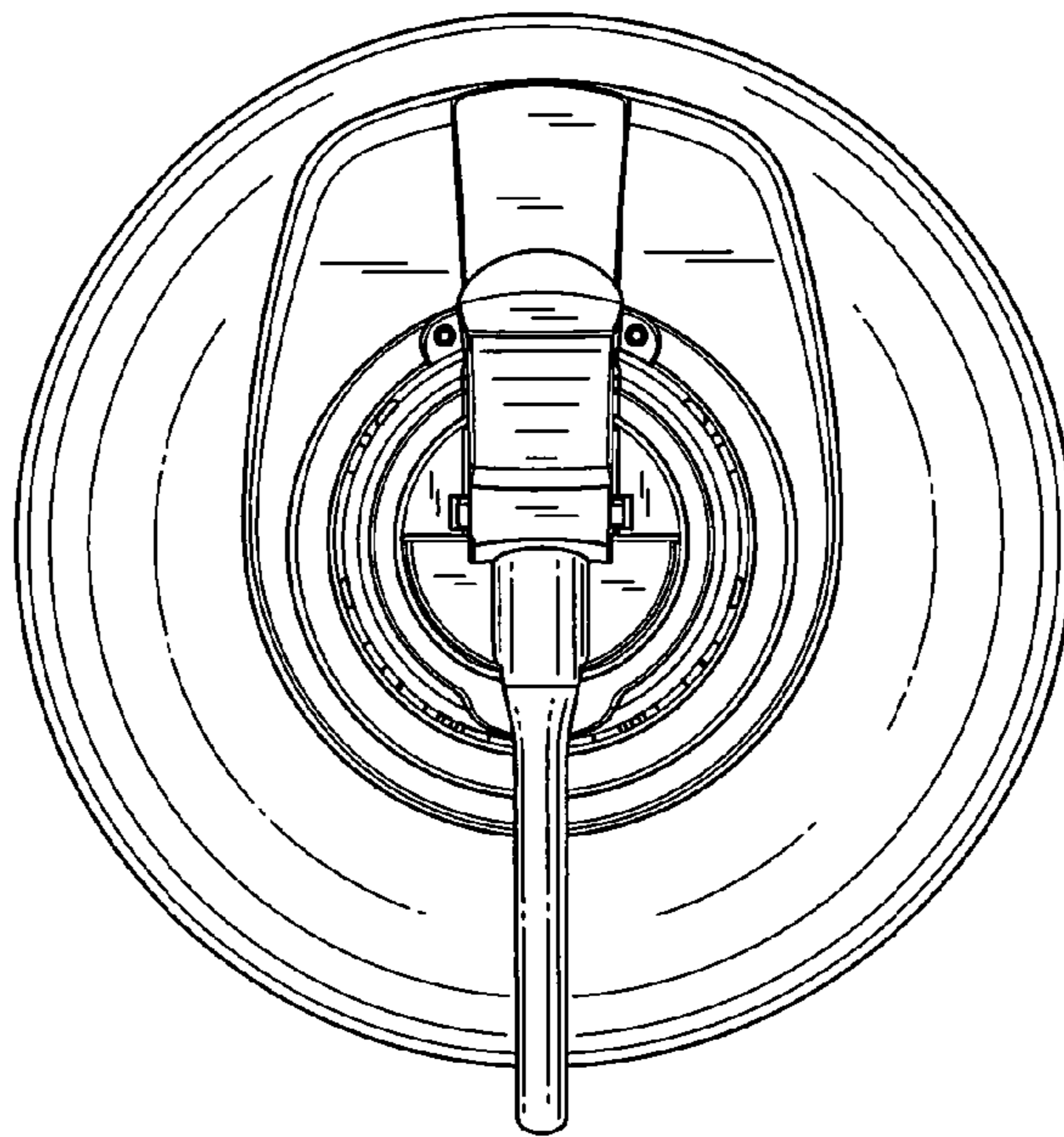
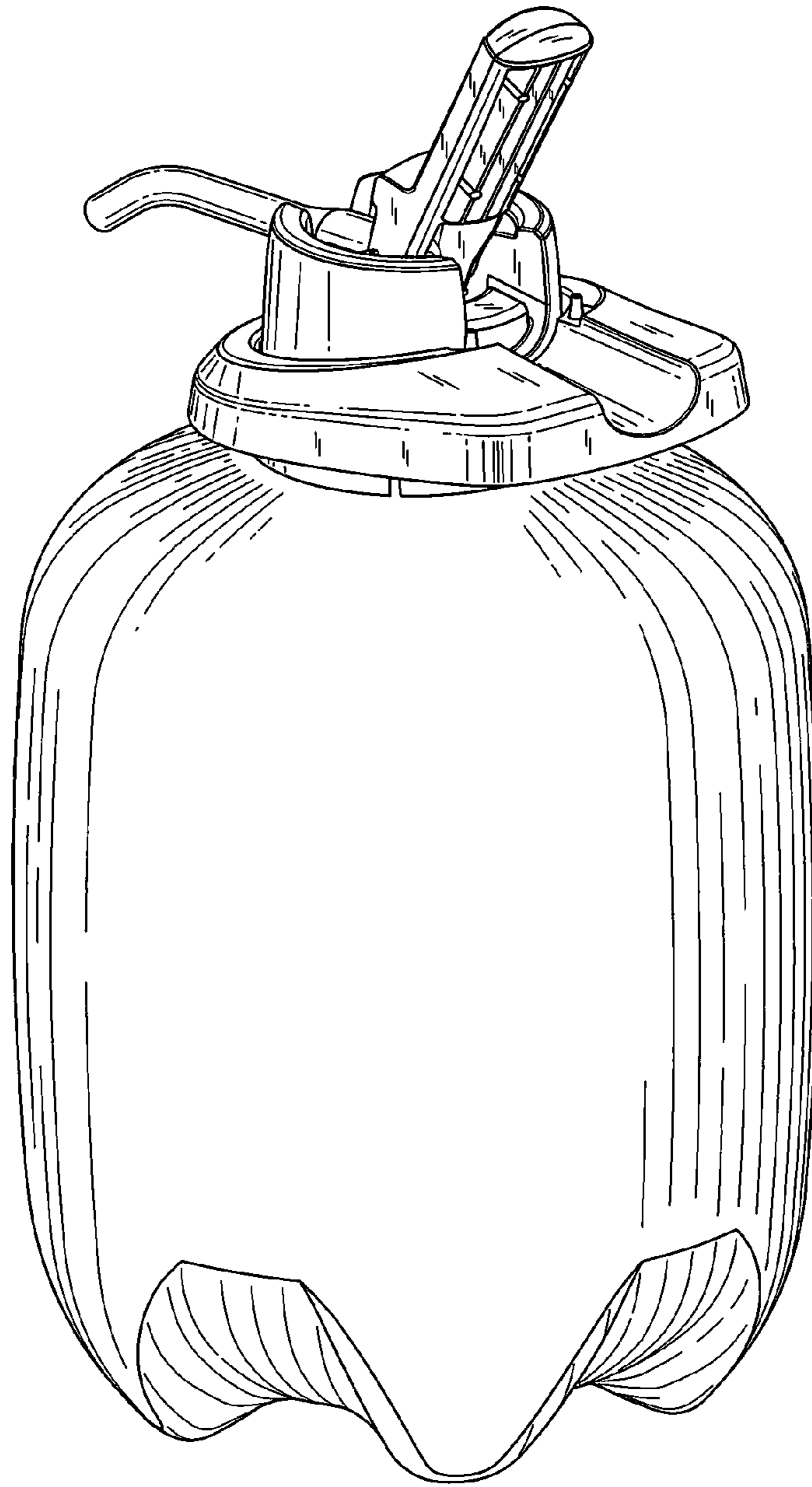


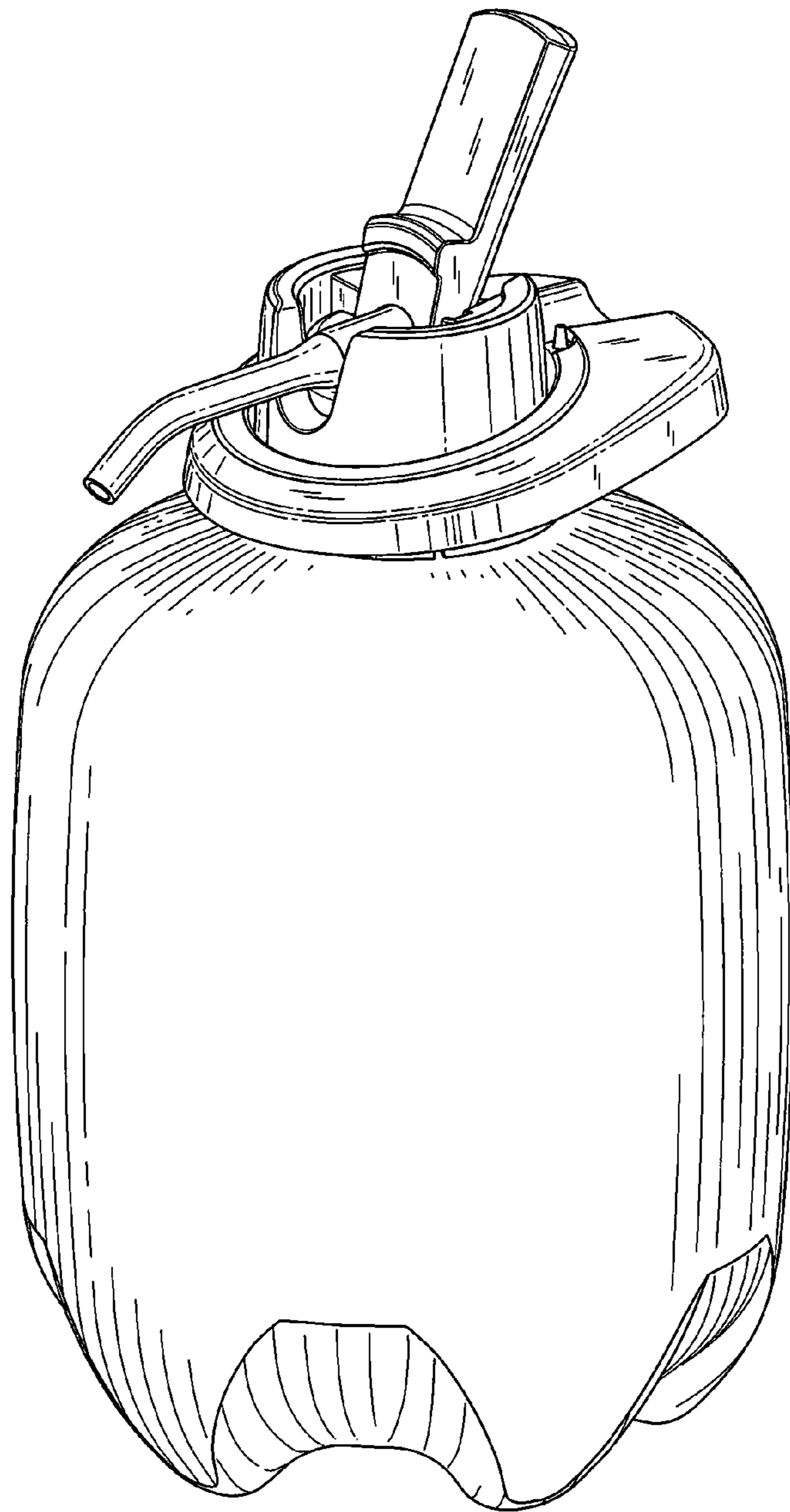
Fig. 9



**Fig. 10**



**Fig. 11**



**Fig. 12**