



US00D662690S

(12) **United States Design Patent**  
**Peoples et al.**

(10) **Patent No.:** **US D662,690 S**

(45) **Date of Patent:** **\*\* Jul. 3, 2012**

(54) **EXERCISE GARMENT**

(76) Inventors: **Jennae Peoples**, Simi Valley, CA (US);  
**Jane Steele**, Simi Valley, CA (US)

(\*\*) Term: **14 Years**

(21) Appl. No.: **29/404,290**

(22) Filed: **Oct. 18, 2011**

(51) **LOC (9) Cl.** ..... **02-02**

(52) **U.S. Cl.** ..... **D2/731**

(58) **Field of Classification Search** ..... D2/700,  
D2/717, 741, 749, 750, 751, 840, 841, 844,  
D2/845, 847, 731; 2/90, 106, 113, 114, 115;  
D29/101.3-101.5

See application file for complete search history.

(56) **References Cited**

**U.S. PATENT DOCUMENTS**

50,702	A	5/1917	Perillat	
2,374,093	A	4/1945	Gluckin	
3,409,007	A *	11/1968	Fuller	600/382
4,425,667	A *	1/1984	Harrison	2/462
4,538,614	A	9/1985	Henderson	
4,590,622	A *	5/1986	Wolfe et al.	2/462
D298,365	S *	11/1988	Acerbis	D29/101.2
D300,382	S	3/1989	Keithan	
D300,910	S	5/1989	Buford	
5,004,231	A	4/1991	Alread	
D341,919	S *	12/1993	Grimes	D2/743
D356,400	S *	3/1995	Wagner	D29/101.3
D393,243	S *	4/1998	Ferguson	D2/841
D393,338	S	4/1998	Rubin	
D403,486	S	1/1999	Chetwynd	
5,937,441	A *	8/1999	Raines	2/69
D420,467	S *	2/2000	Breitbach et al.	D29/100
D438,691	S	3/2001	Zagame	
D516,753	S	3/2006	Grissom	
7,090,558	B2	8/2006	Ott	
D550,930	S *	9/2007	Davila et al.	D2/840
D553,299	S *	10/2007	Le Carpentier	D29/101.2
D577,827	S *	9/2008	Miyazawa et al.	D24/188

D609,429	S	2/2010	Erland	
D620,058	S	7/2010	Gaedke	
D629,998	S *	1/2011	Lambertz	D2/704
8,082,602	B2 *	12/2011	Crelinsten et al.	2/455
2004/0154083	A1 *	8/2004	McVicker	2/455

**FOREIGN PATENT DOCUMENTS**

DE 3139463 A1 \* 4/1983

**OTHER PUBLICATIONS**

Dakka Dakka. <http://www.dakkadakka.com/dakkaforum/posts/list/480/394917.page>. Nov. 2011. "Female Armour".\*

This or That (blog) <http://thisorthat.com/blog/7-badass-action-heroines-with-completely-impractical-outfits>. Date Unknown: Viewed Feb. 2012. "Female Body Armour".\*

\* cited by examiner

*Primary Examiner* — Rashida Johnson

(74) *Attorney, Agent, or Firm* — QuickPatents, Inc.; Kevin Prince

(57) **CLAIM**

We claim the ornamental design for an exercise garment, as shown and described.

**DESCRIPTION**

FIG. 1 is a perspective view of an exercise garment, showing a first embodiment of our new design; FIG. 2 is a front elevational view thereof; FIG. 3 is a rear elevational view thereof; FIG. 4 is a left-side elevational view thereof; FIG. 5 is a right-side elevational view thereof; FIG. 6 is a top plan view thereof; and, FIG. 7 is a bottom plan view thereof.

The broken lines showing a person in FIG. 1 and design elements in FIGS. 1, 2, and 4 depict environmental matter and form no part of the claimed design.

**1 Claim, 3 Drawing Sheets**

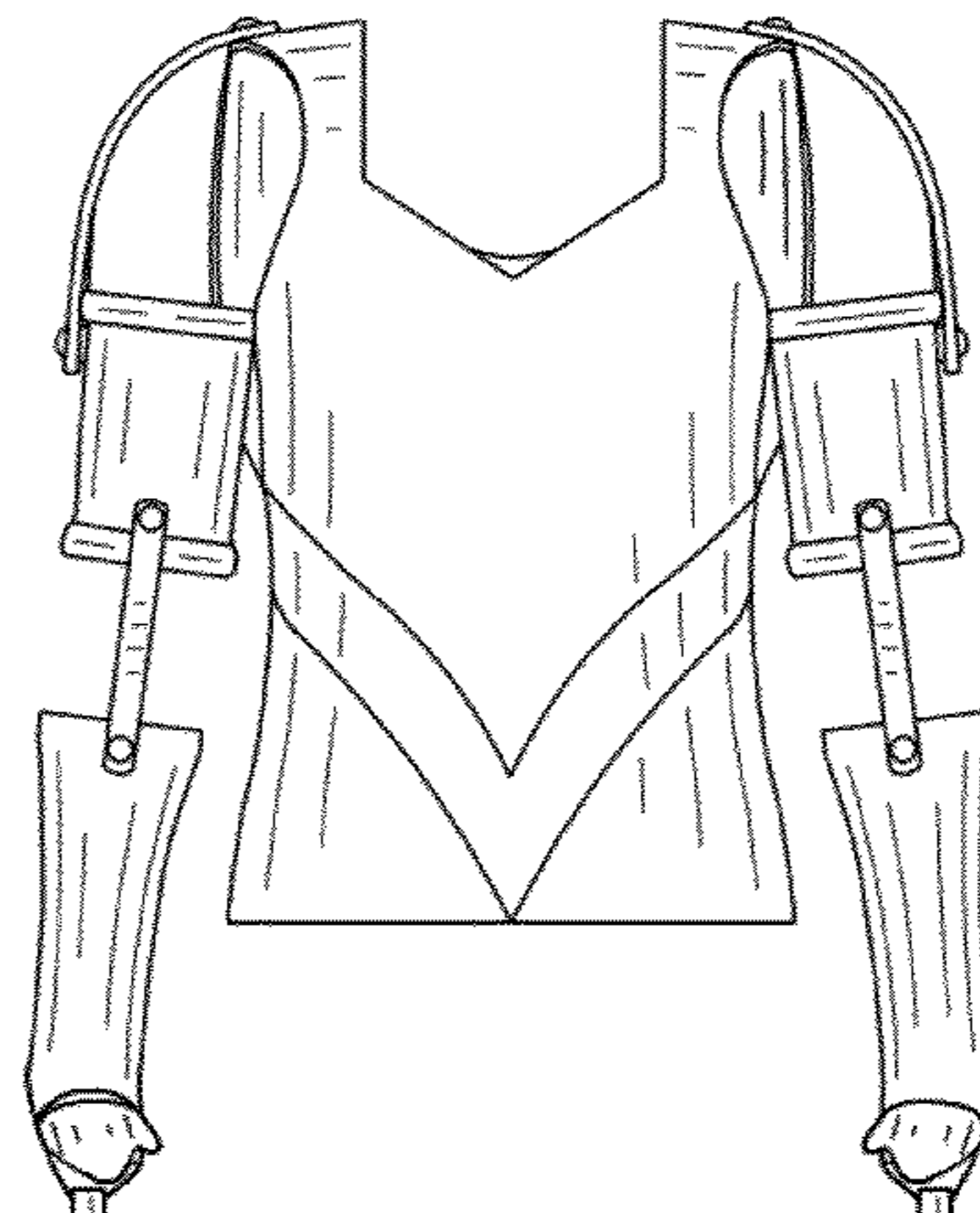
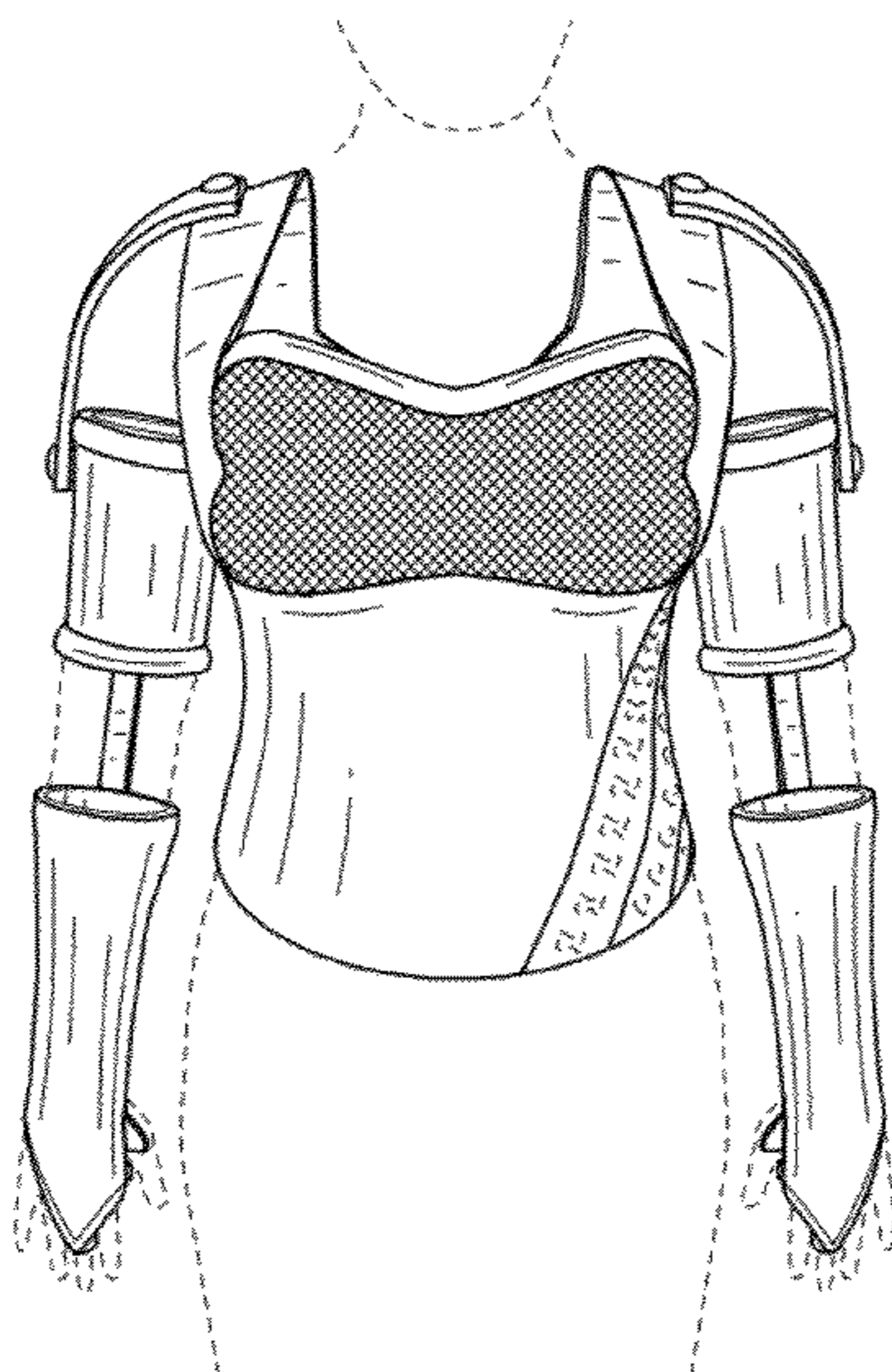

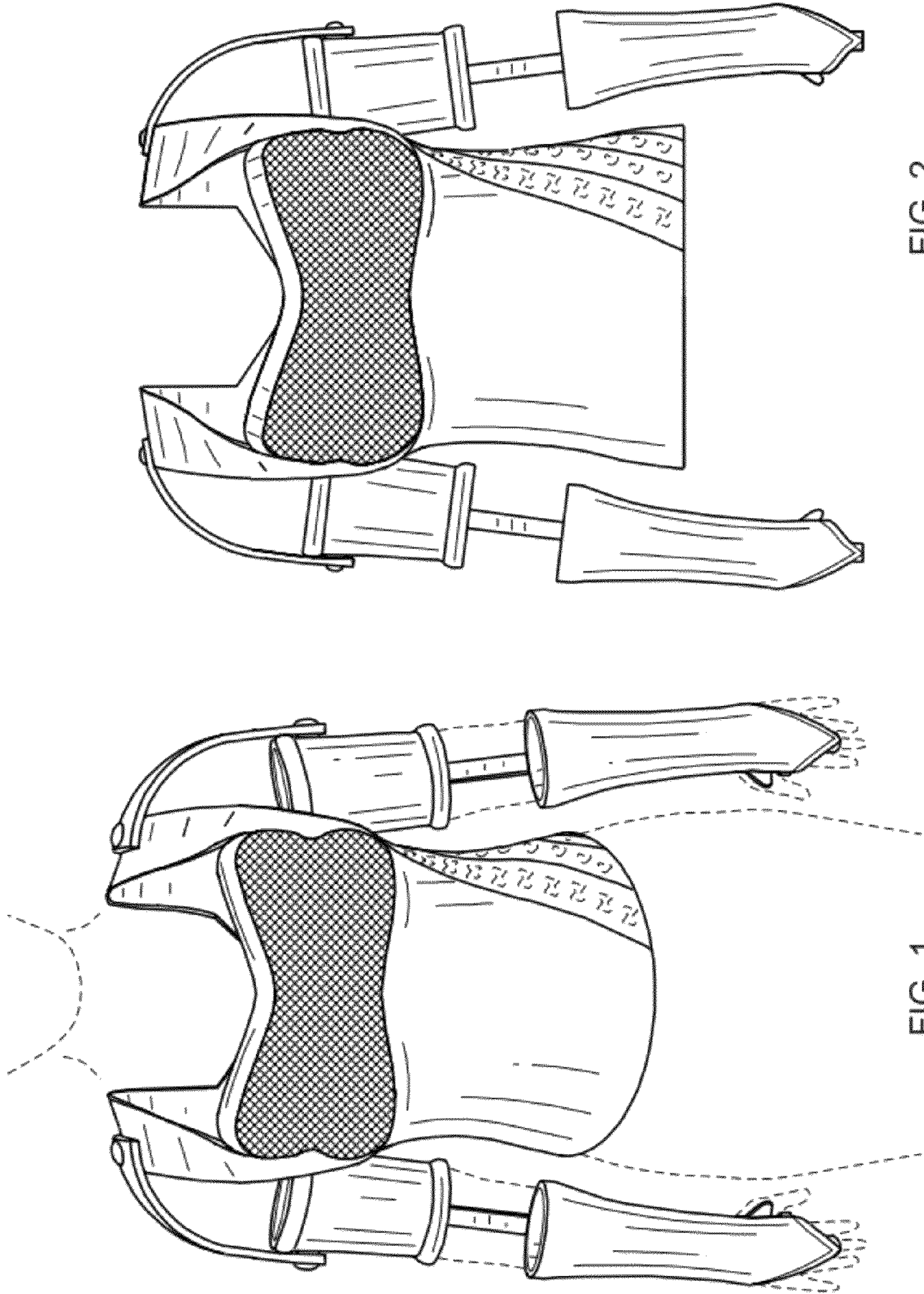

FIG. 2

FIG. 1

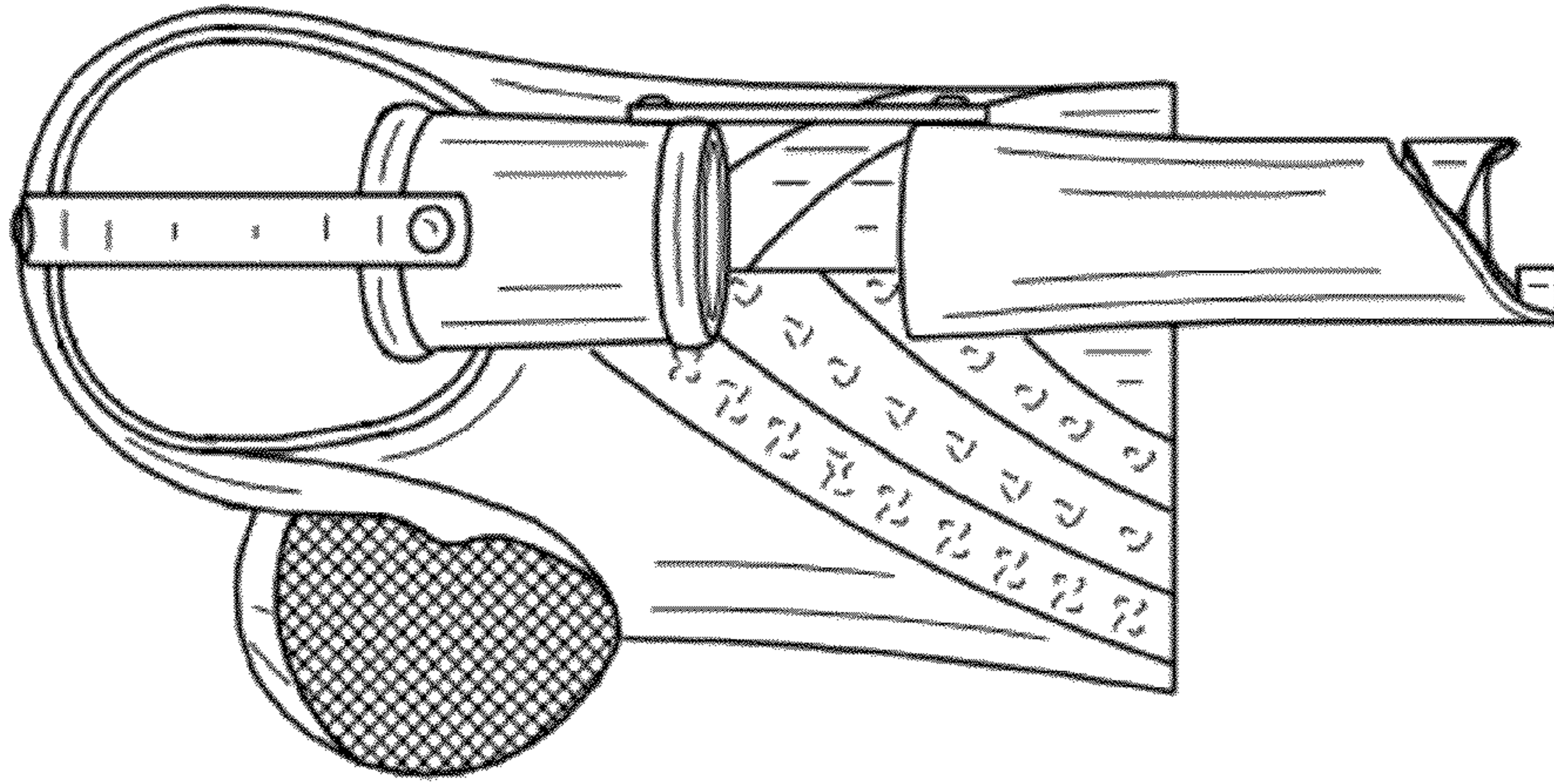

FIG. 4

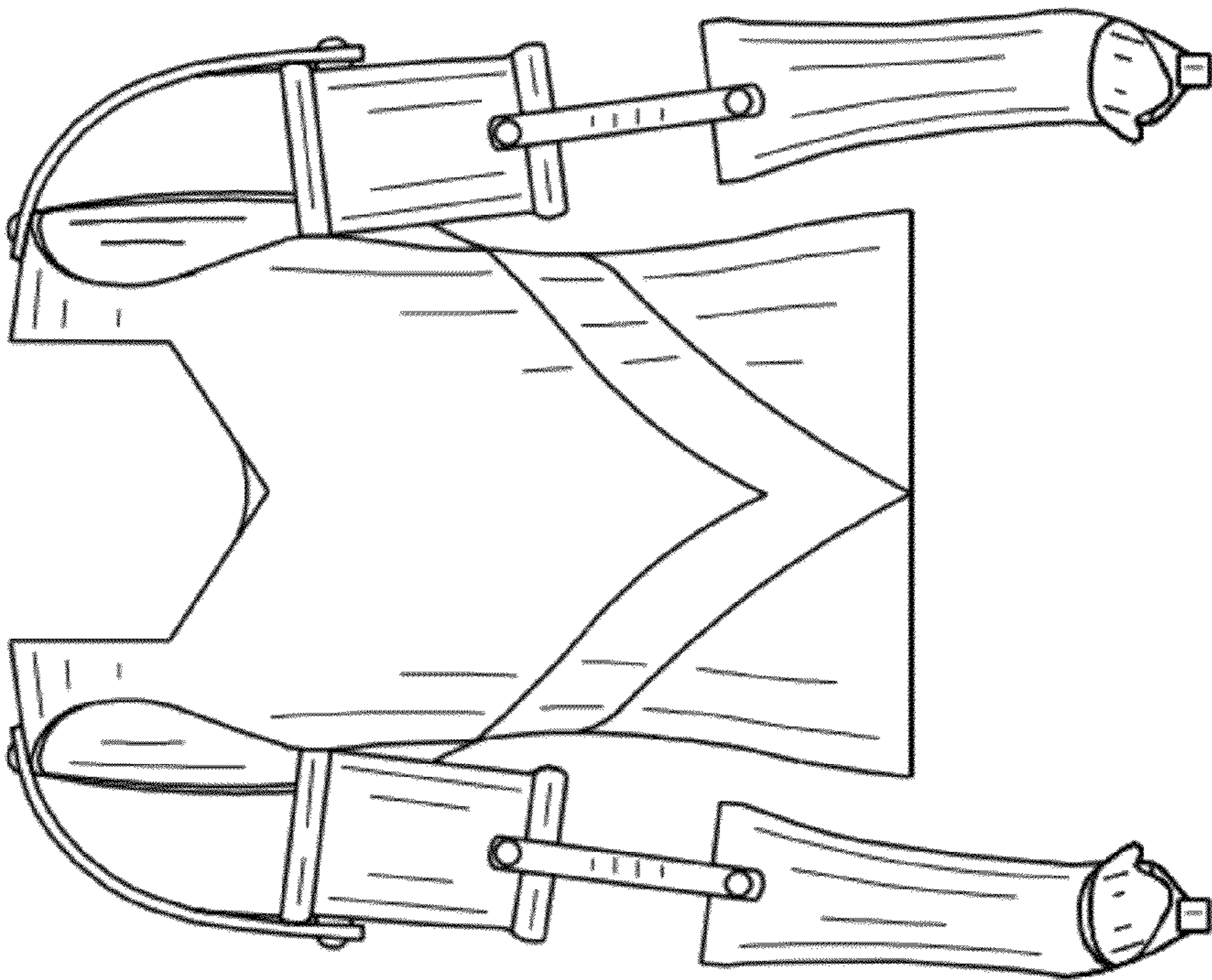

FIG. 3

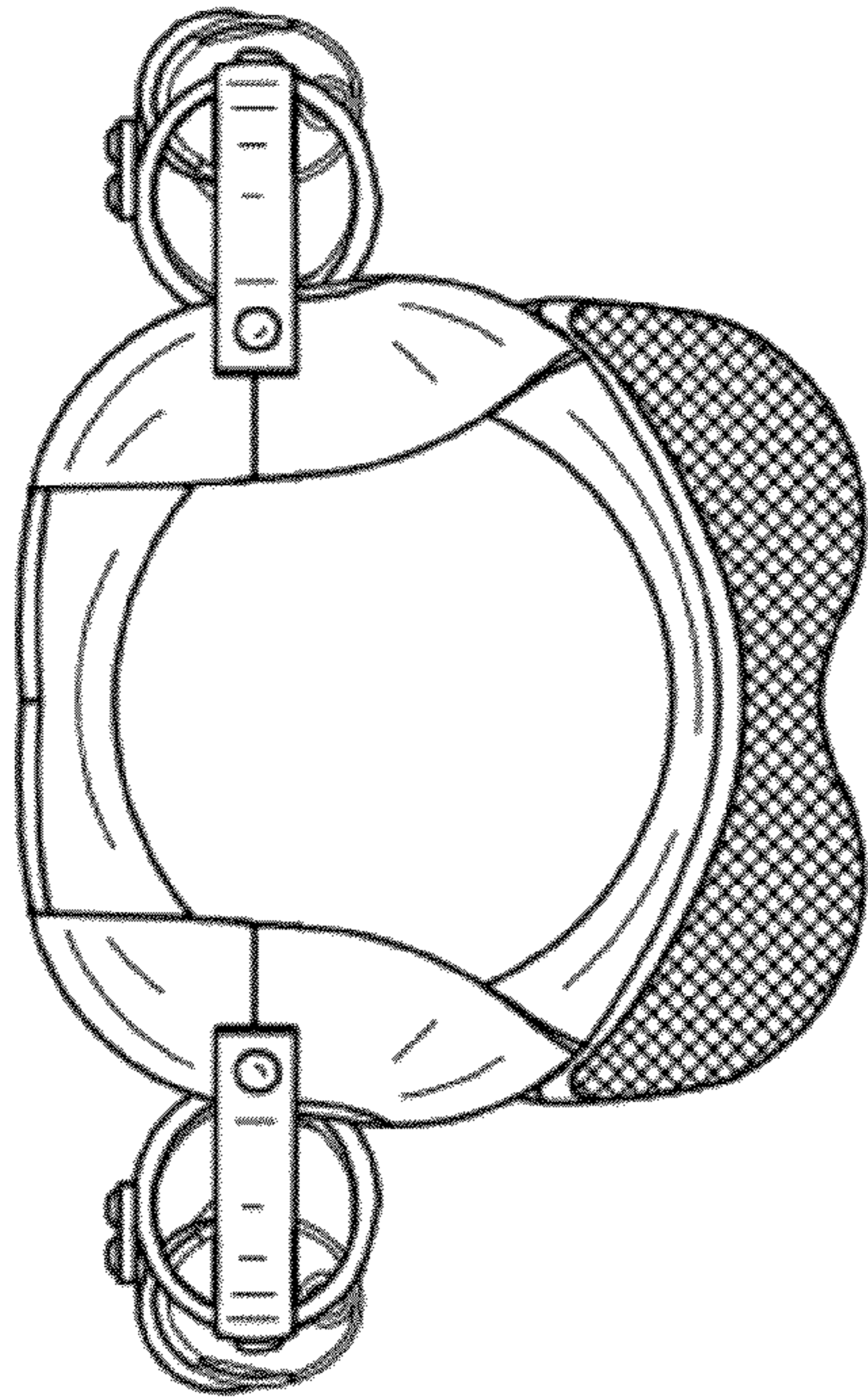

FIG. 6

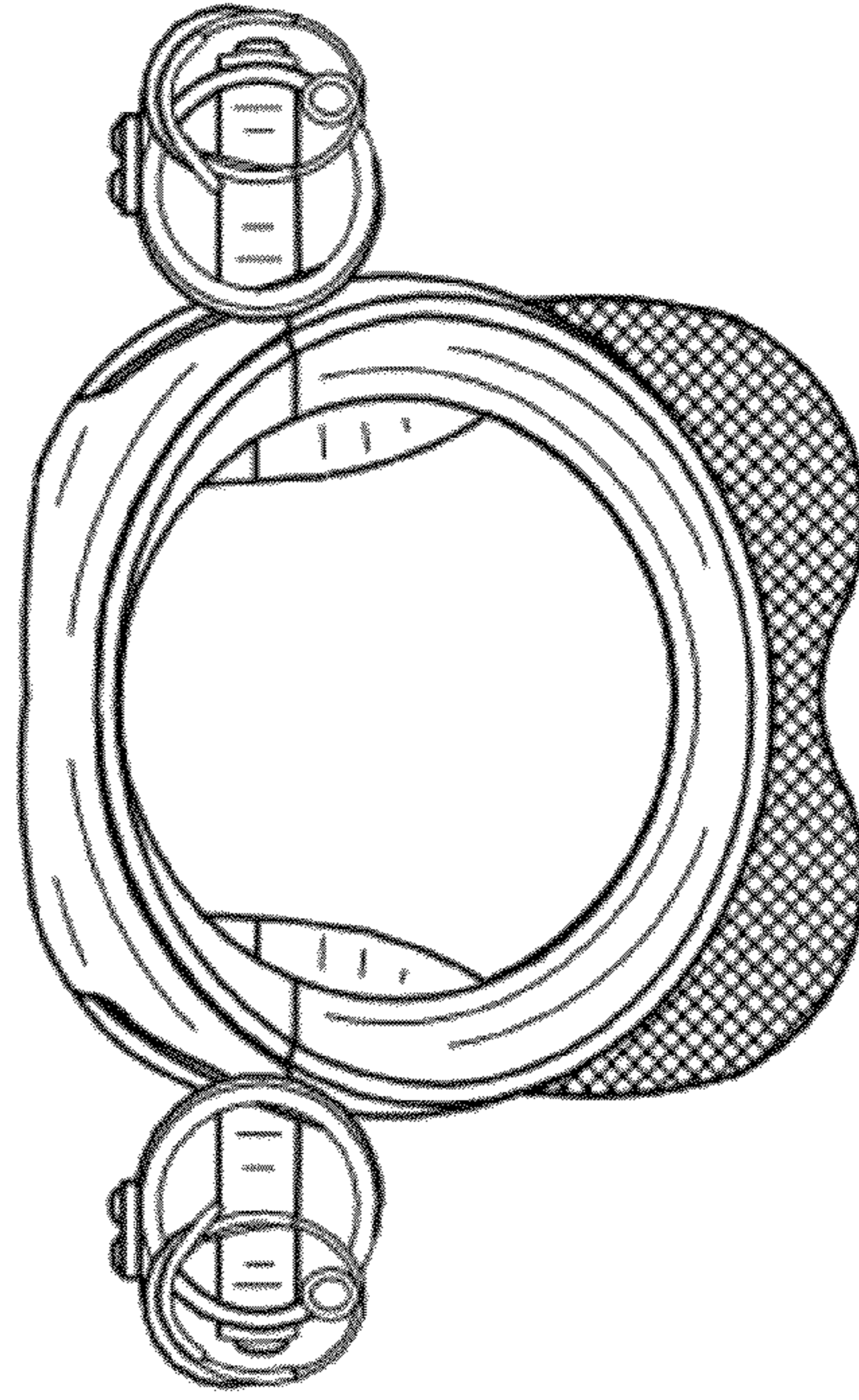

FIG. 7

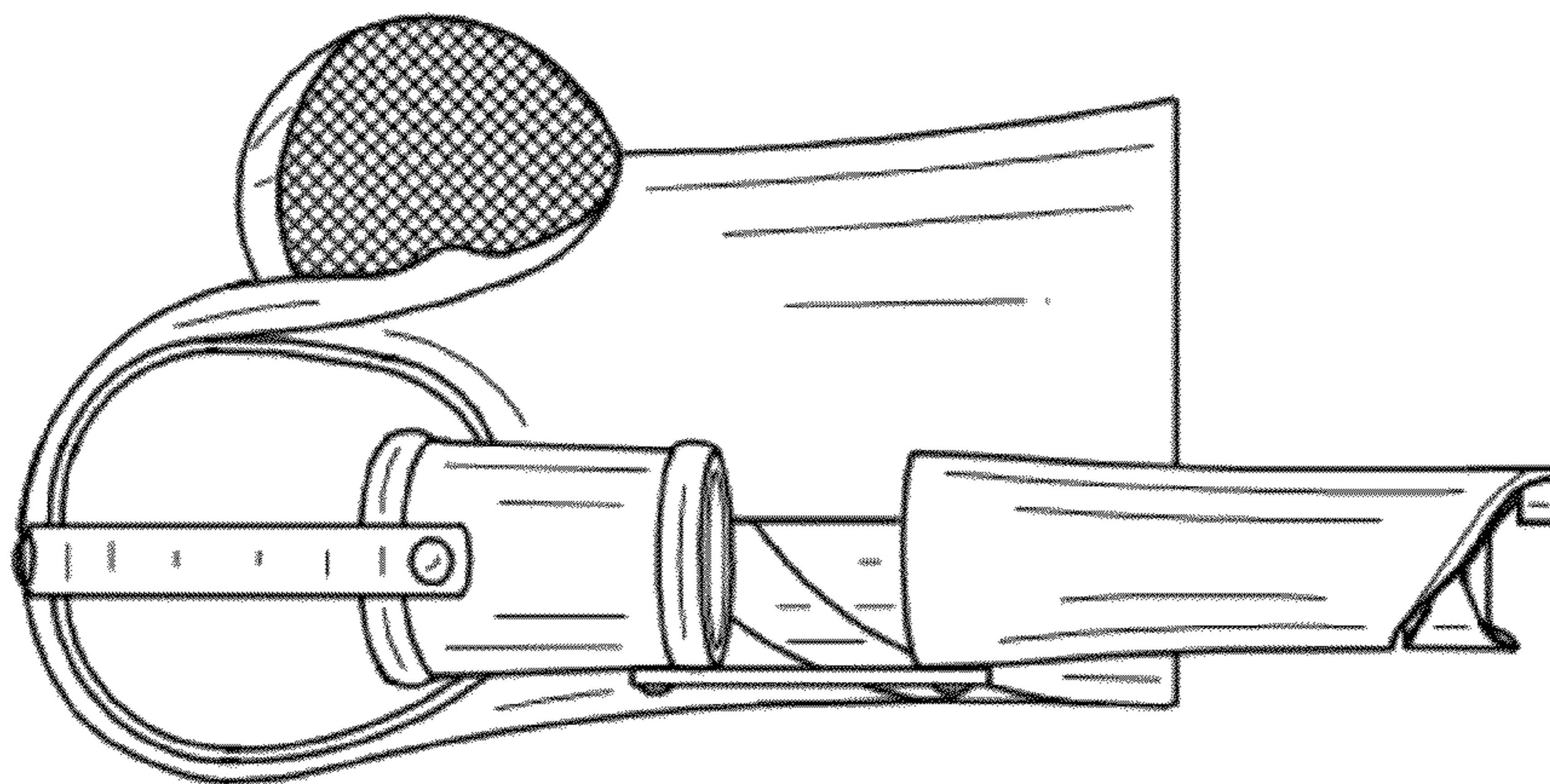

FIG. 5