

US00D662582S

(12) **United States Design Patent**
Olchovy et al.

(10) **Patent No.:** **US D662,582 S**
(45) **Date of Patent:** **** Jun. 26, 2012**

(54) **AIR FRESHENER HOUSING**
(75) Inventors: **Jason John Olchovy**, West Chester, OH (US); **Ada Ho Yau Ko**, Cincinnati, OH (US); **Norio Fujikawa**, San Francisco, CA (US); **Byron Ben-Ming Hsieh**, San Francisco, CA (US)

(73) Assignee: **The Procter & Gamble Company**, Cincinnati, OH (US)

(**) Term: **14 Years**

(21) Appl. No.: **29/410,440**

(22) Filed: **Jan. 9, 2012**

(51) **LOC (9) Cl.** **28-99**

(52) **U.S. Cl.** **D23/366**

(58) **Field of Classification Search** D23/355-369;
D28/5, 6; 261/DIG. 17, DIG. 42, DIG. 65,
261/DIG. 88, DIG. 89; 392/386, 390, 394,
392/395; 239/34, 44, 53, 55, 56, 326; D26/14,
D26/17, 98

See application file for complete search history.

(56) **References Cited**

U.S. PATENT DOCUMENTS

D250,041 S	10/1978	Schimanski	
D262,138 S *	12/1981	Bousgarbies et al.	D23/366
4,849,606 A *	7/1989	Martens et al.	392/390
D345,787 S *	4/1994	Martin	D23/366
5,478,505 A *	12/1995	McElfresh et al.	261/30
5,527,493 A *	6/1996	McElfresh et al.	261/30
D373,822 S *	9/1996	Leonard et al.	D23/366
D385,025 S *	10/1997	Ho	D23/367
D395,146 S	6/1998	Miller et al.	
D449,099 S	10/2001	Juhlin et al.	
D484,228 S	12/2003	Zhang et al.	
D496,720 S	9/2004	Dudley	
D504,943 S	5/2005	Dudley	
D508,285 S	8/2005	Velicescu	
D508,559 S *	8/2005	Spiegel et al.	D23/366
D509,578 S	9/2005	Yao	
D510,422 S	10/2005	Schriner et al.	
D522,640 S	6/2006	Miro	
D544,087 S	6/2007	Baraky et al.	

D570,980 S	6/2008	Isono et al.	
D585,536 S	1/2009	Wang	
D596,281 S	7/2009	Schwartz et al.	
D609,322 S	2/2010	Schwartz et al.	
D631,146 S *	1/2011	Shu et al.	D23/366
D638,531 S *	5/2011	Irwin et al.	D23/366
D642,667 S *	8/2011	Irwin et al.	D23/366
2008/0253755 A1	10/2008	Smith et al.	

* cited by examiner

Primary Examiner — Sandra Snapp

(74) *Attorney, Agent, or Firm* — Amy I Ahn-Roll; Leonard W Lewis

(57) **CLAIM**

The ornamental design for an air freshener housing, as shown and described.

DESCRIPTION

FIG. 1 is a perspective view of one embodiment of an air freshener housing according to the present invention;
 FIG. 2 is a front elevational view thereof;
 FIG. 3 is a rear elevational view thereof;
 FIG. 4 is a left side elevational view thereof;
 FIG. 5 is a right side elevational view thereof;
 FIG. 6 is a top view thereof;
 FIG. 7 is a bottom view thereof;
 FIG. 8 is a perspective view of a second embodiment of an air freshener housing according to the present invention;
 FIG. 9 is a front elevational view thereof;
 FIG. 10 is a rear elevational view thereof;
 FIG. 11 is a left side elevational view thereof;
 FIG. 12 is a right side elevational view thereof;
 FIG. 13 is a top view thereof;
 FIG. 14 is a bottom view thereof.
 FIG. 15 is a perspective view of a third embodiment of an air freshener housing according to the present invention;
 FIG. 16 is a front elevational view thereof;
 FIG. 17 is a rear elevational view thereof;
 FIG. 18 is a left side elevational view thereof;
 FIG. 19 is a right side elevational view thereof;
 FIG. 20 is a top view thereof; and,
 FIG. 21 is a bottom view thereof.

The broken lines shown in the drawings are for illustrative purposes only and form no part of the claimed design.

1 Claim, 6 Drawing Sheets

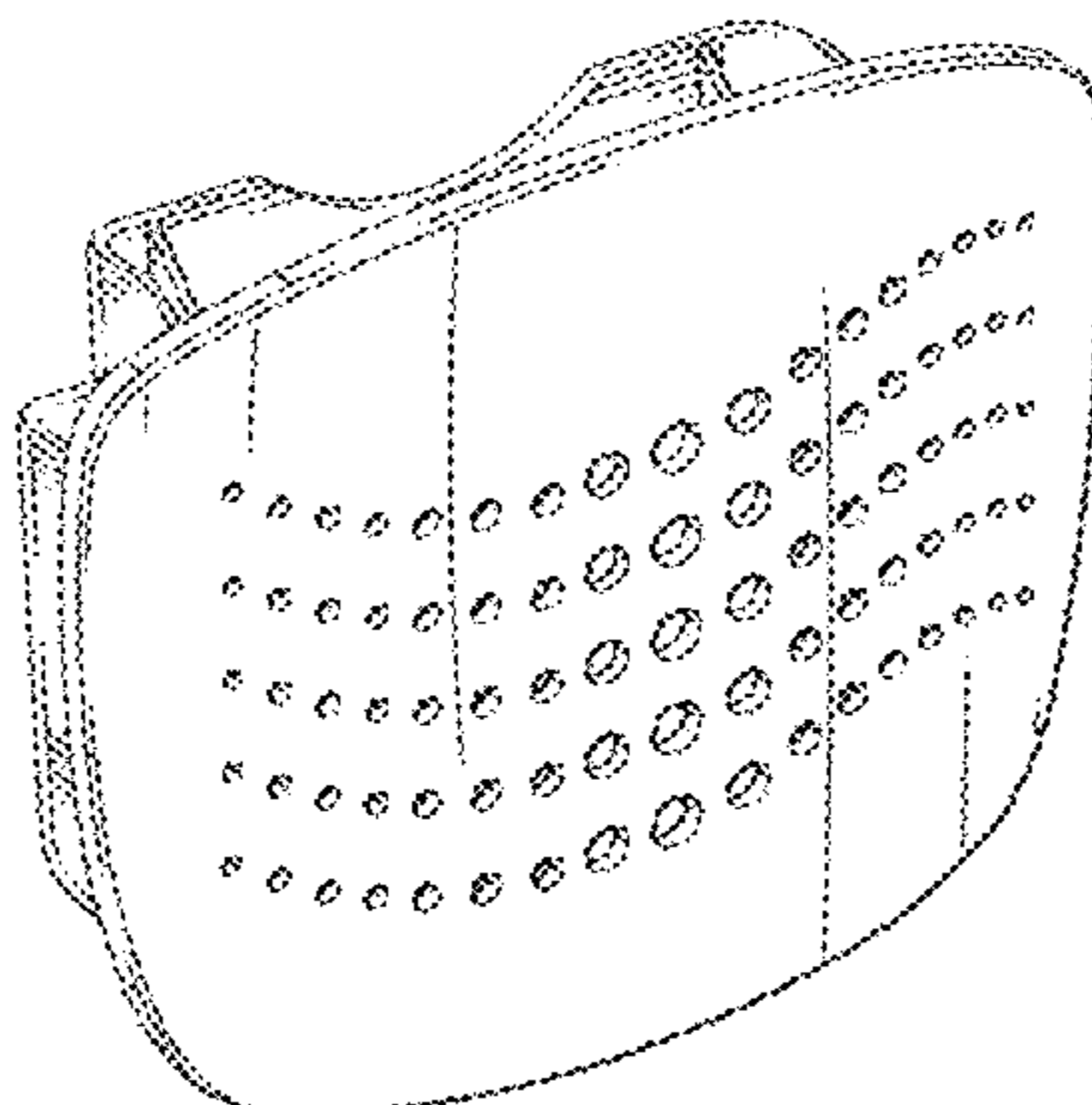

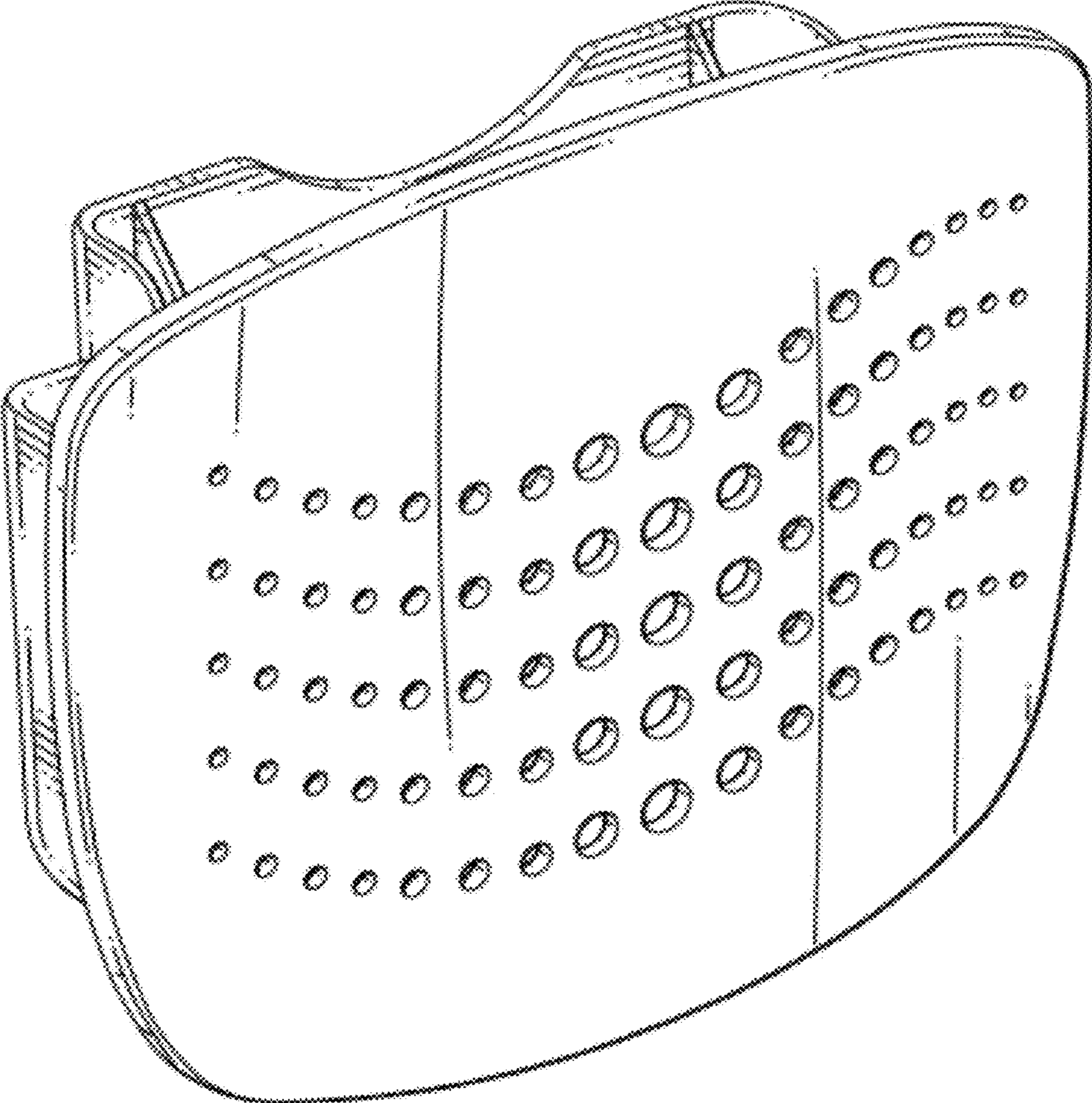

FIG. 1

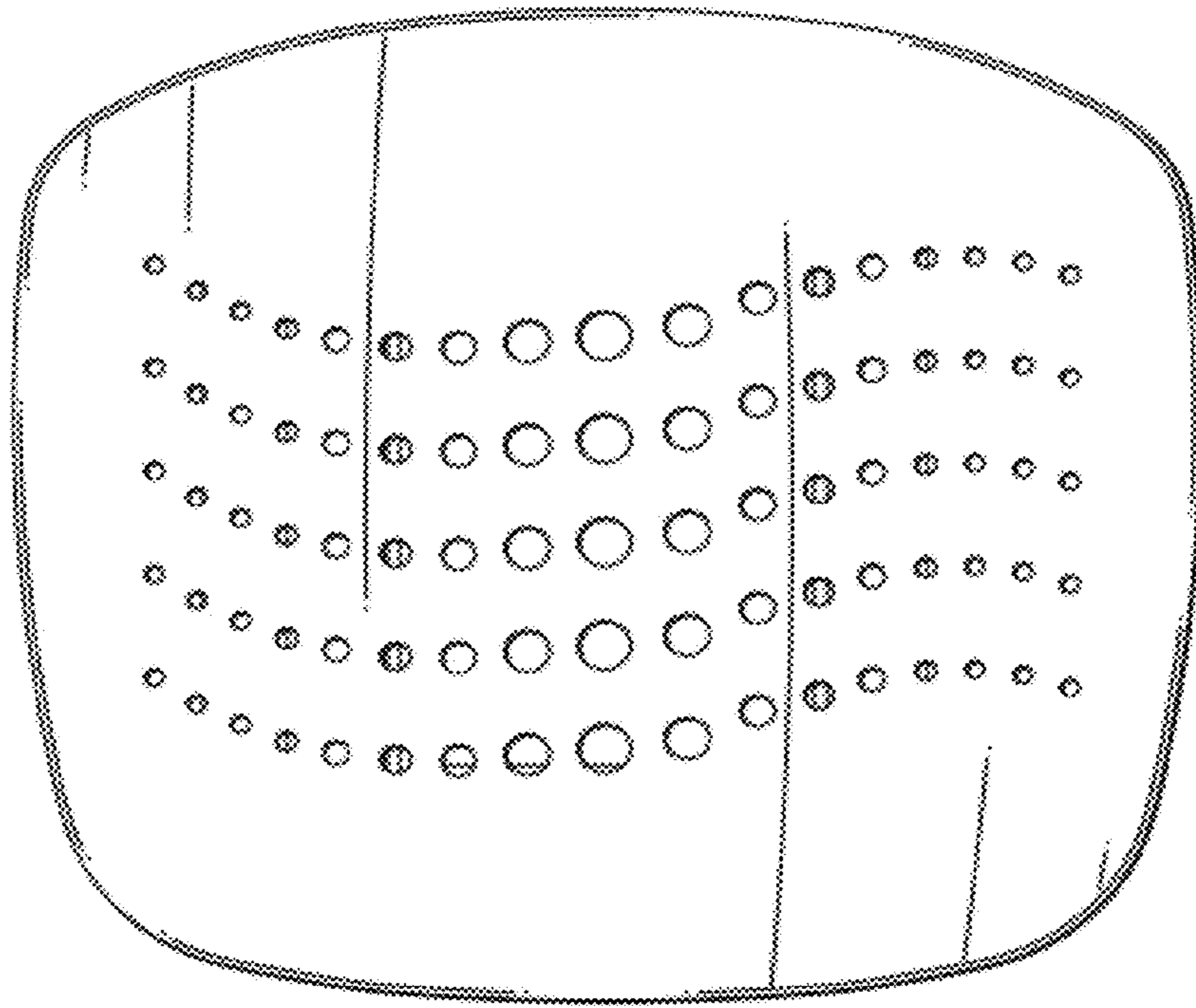

FIG. 2

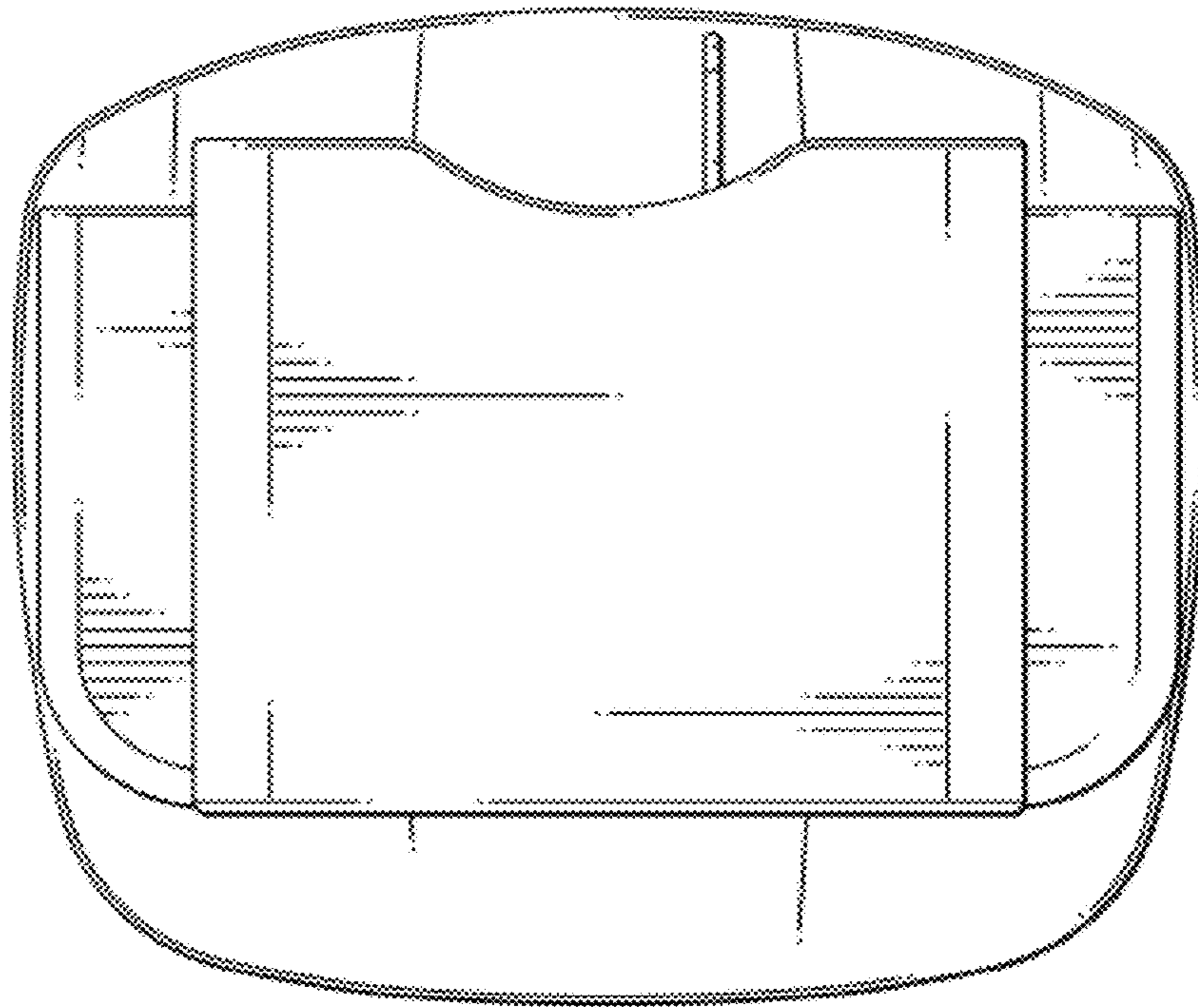

FIG. 3

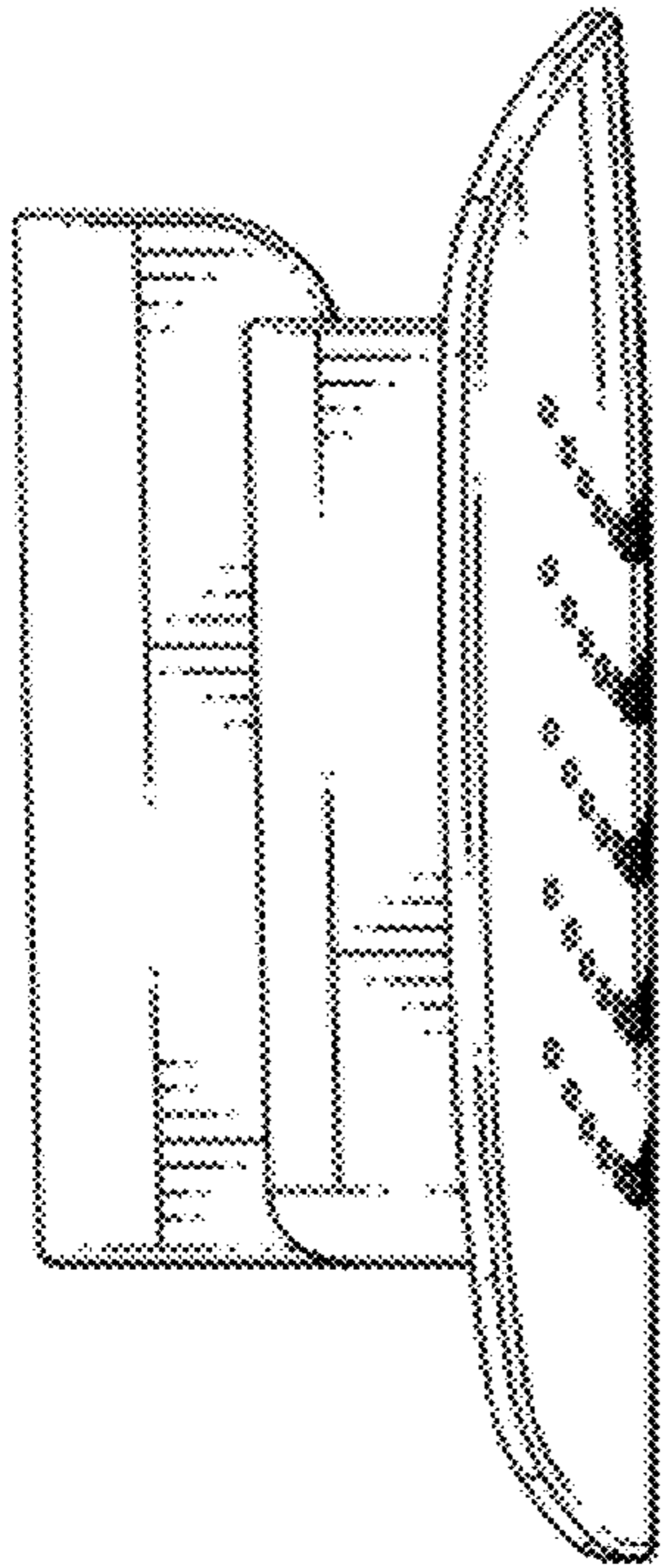

FIG. 4

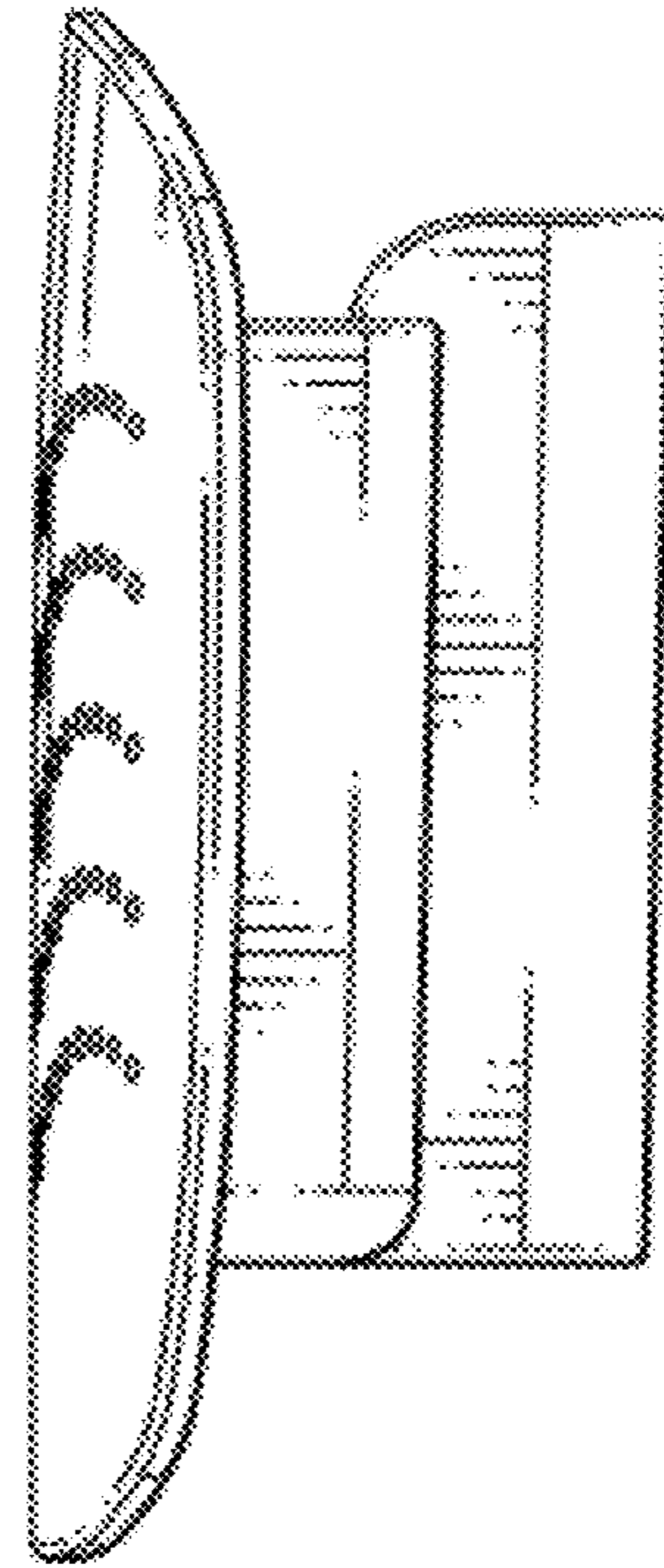

FIG. 5

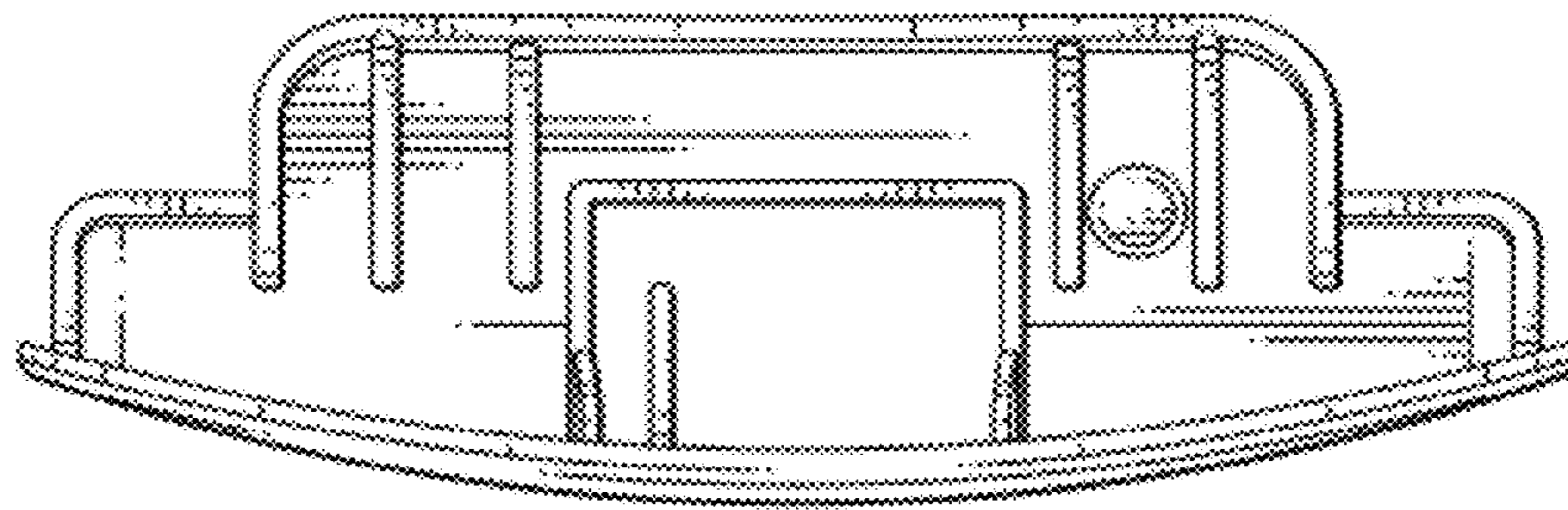

FIG. 6

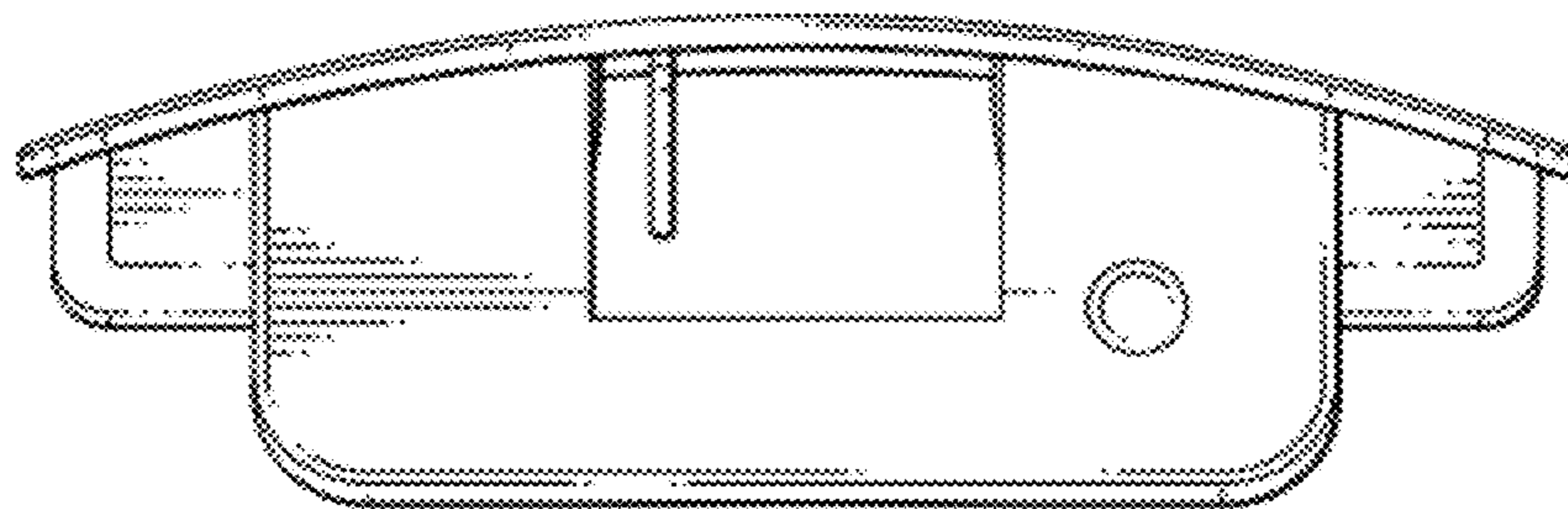

FIG. 7

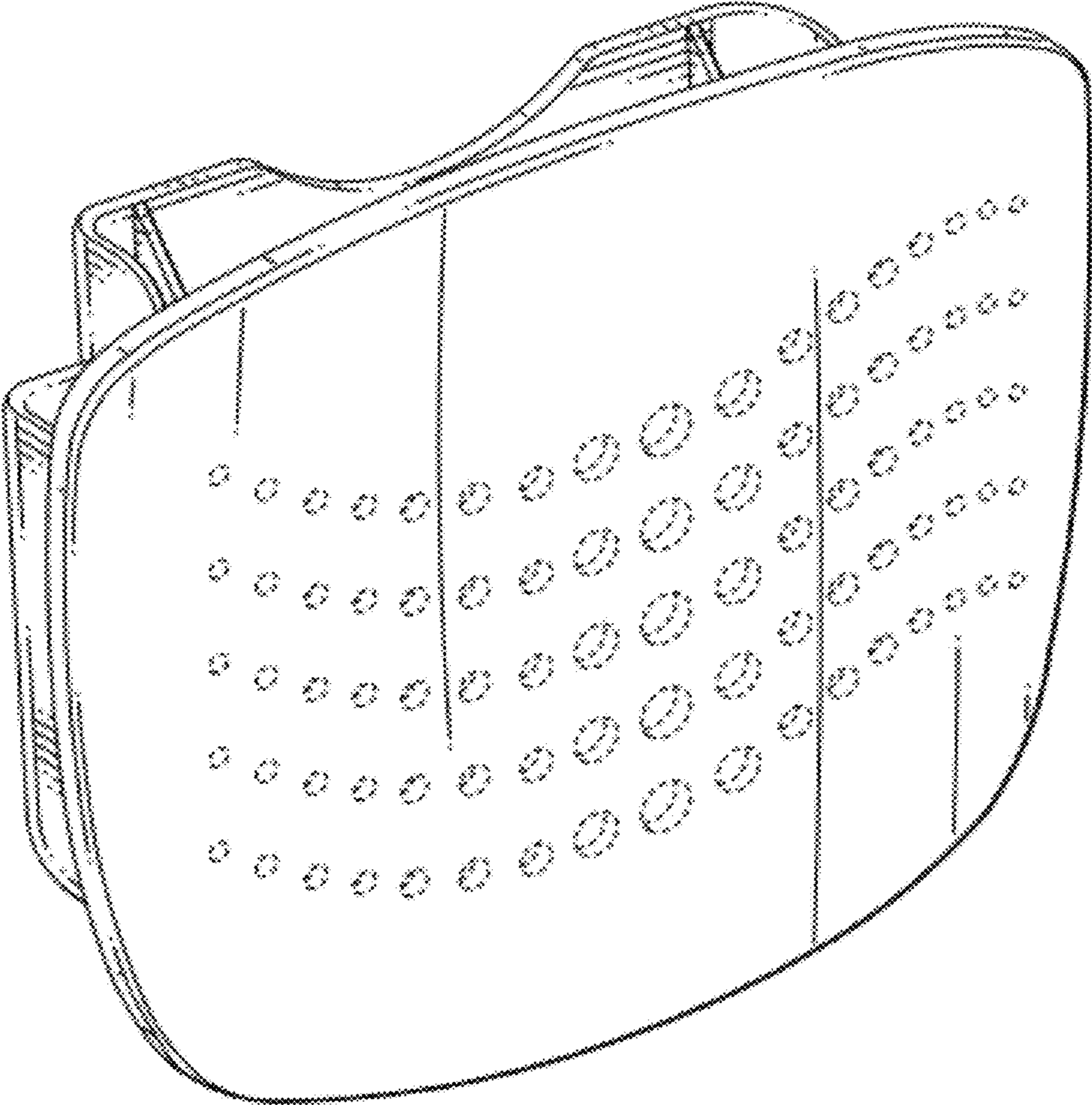

FIG. 8

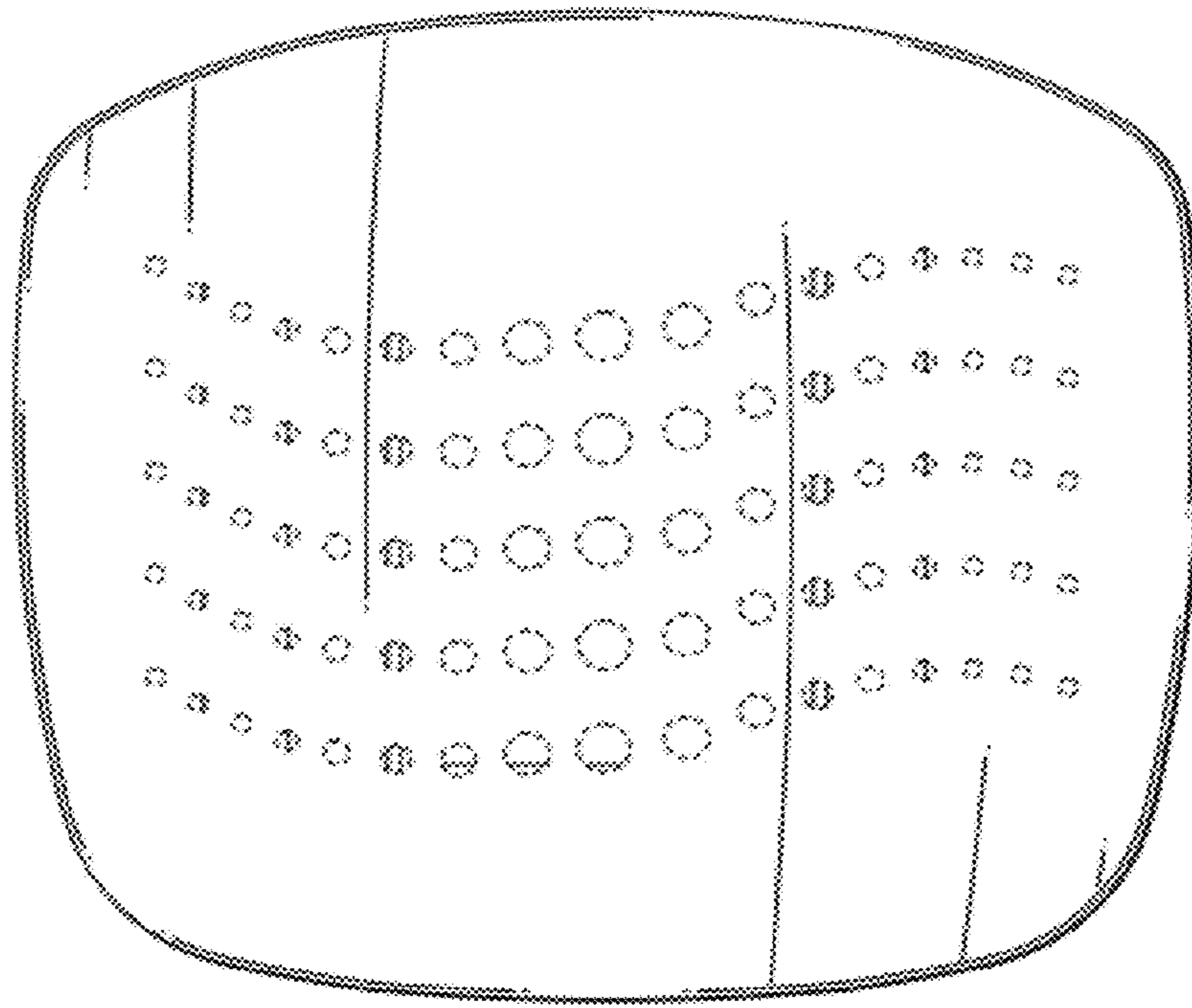

FIG. 9

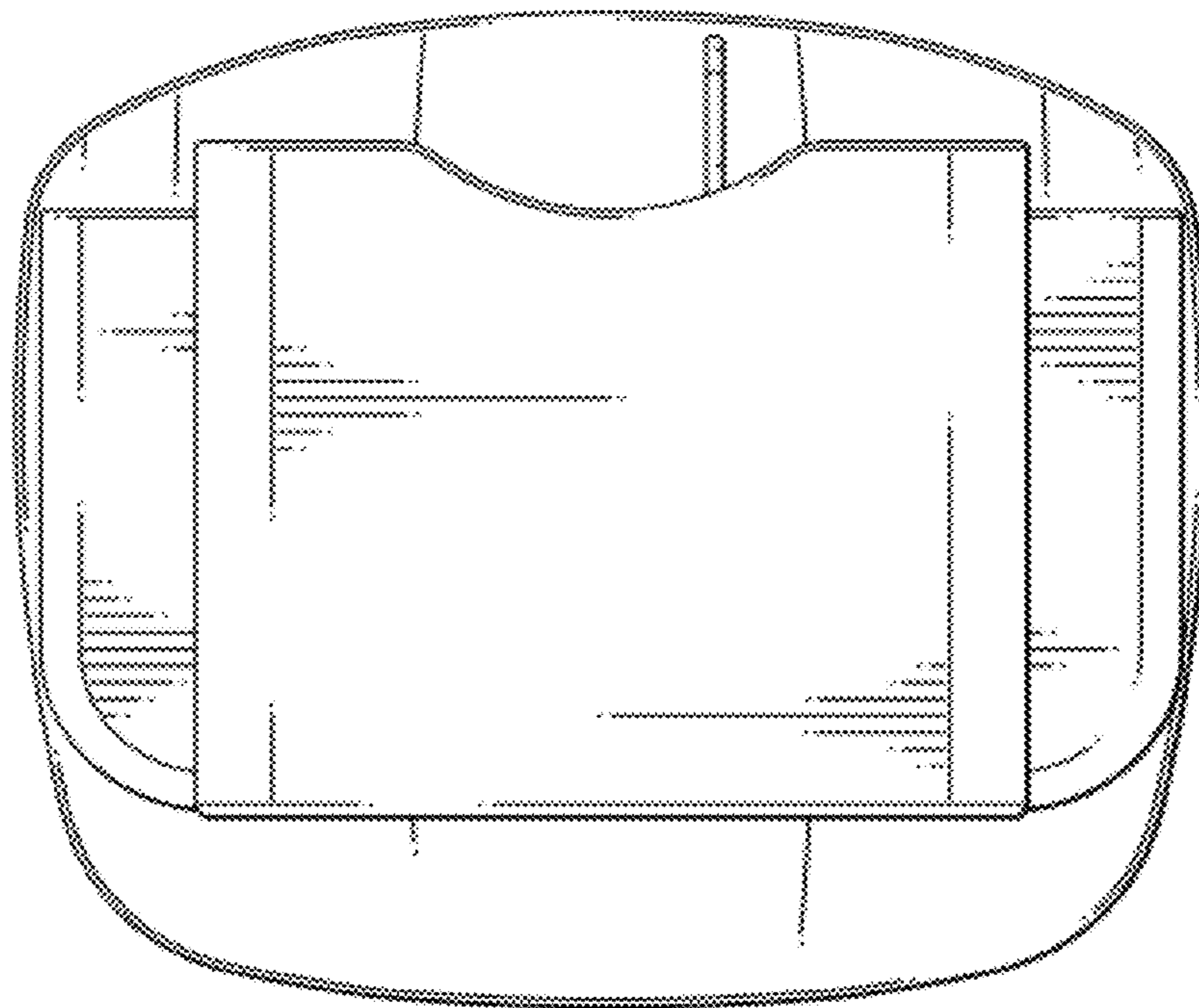

FIG. 10

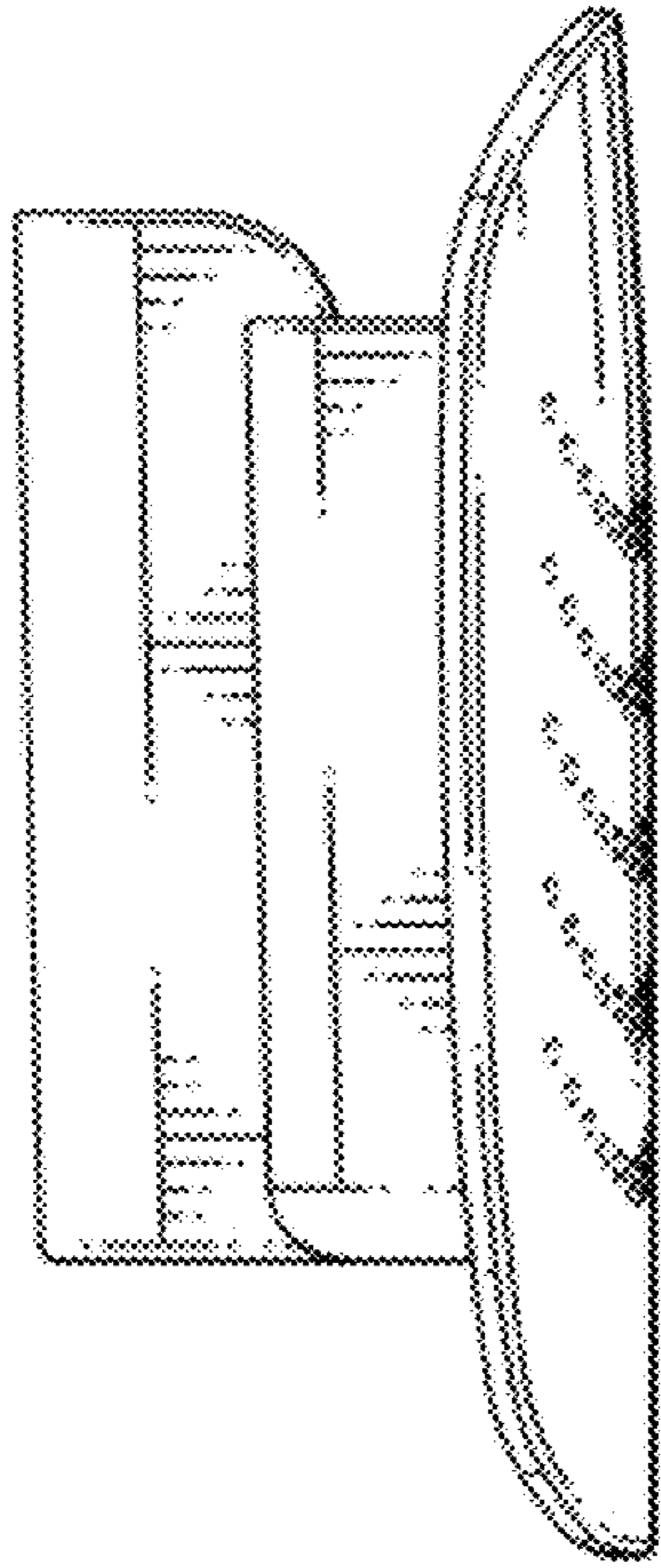

FIG. 11

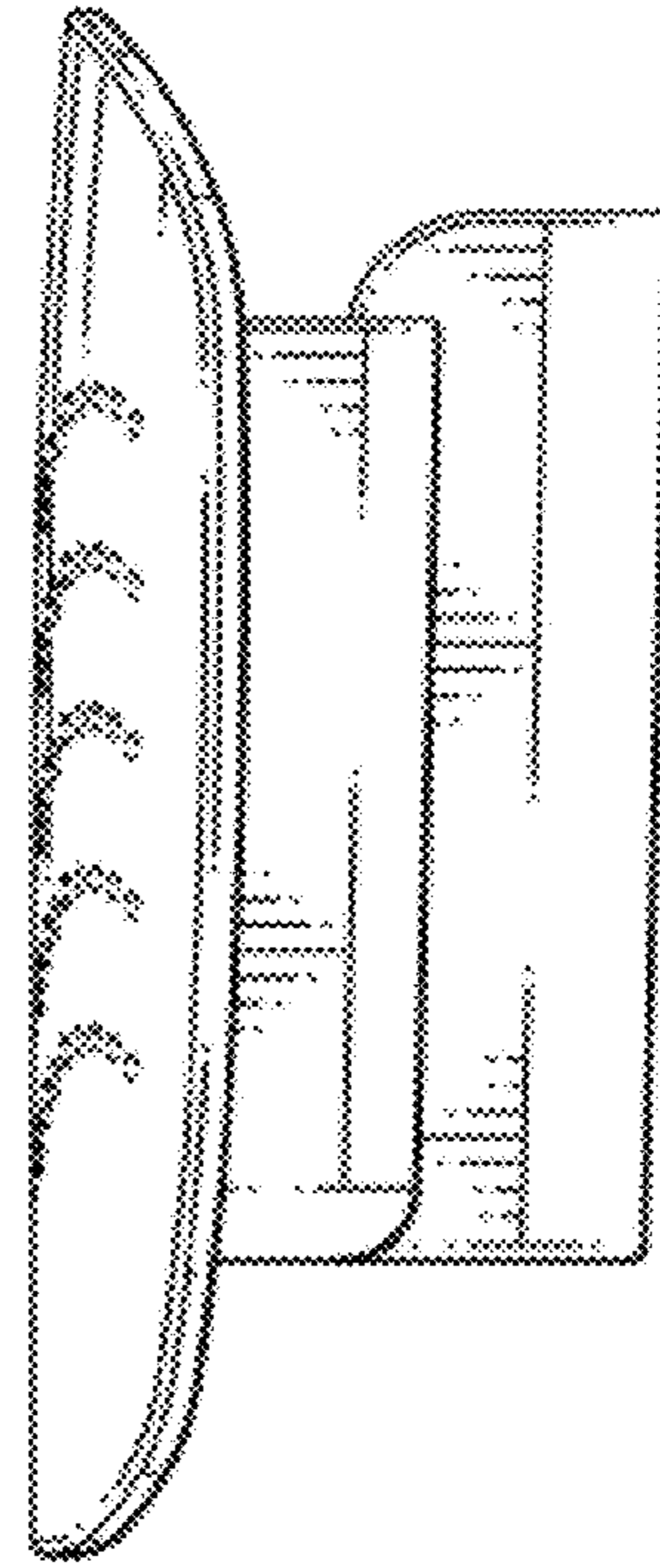

FIG. 12

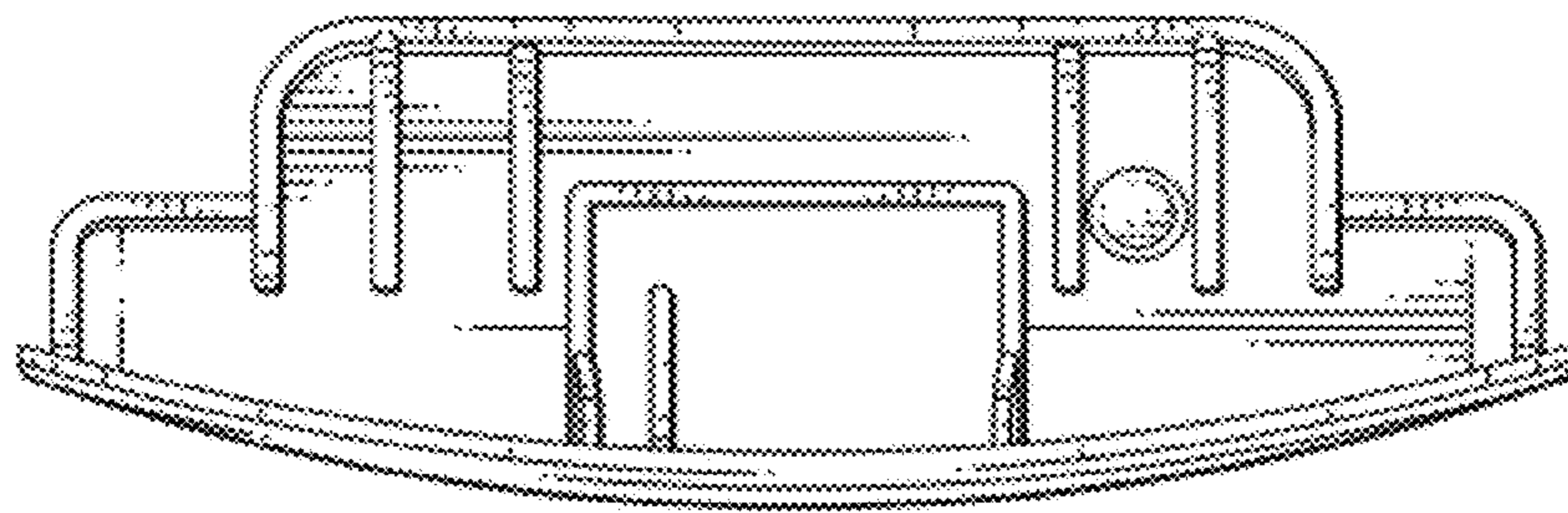

FIG. 13

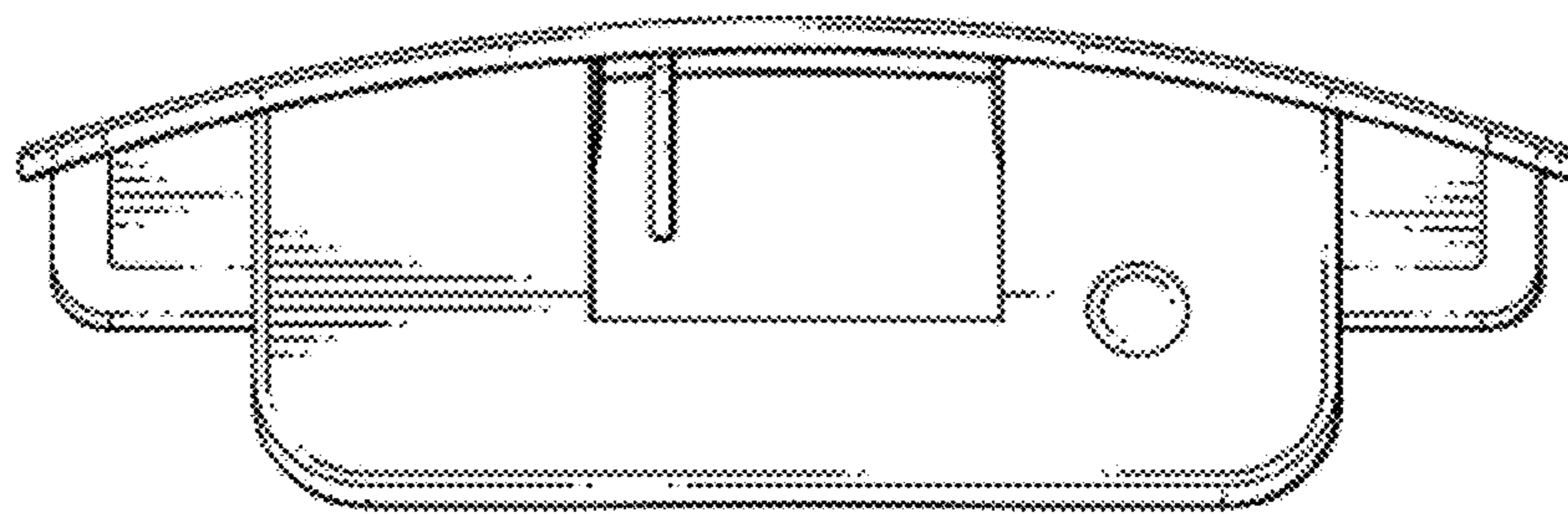

FIG. 14