

US00D662564S

(12) **United States Design Patent**
Peterson

(10) **Patent No.:** **US D662,564 S**

(45) **Date of Patent:** **** Jun. 26, 2012**

(54) **INFLATABLE TOWABLE VEHICLE**

(76) Inventor: **Leroy L. Peterson**, Omaha, NE (US)

(**) Term: **14 Years**

(21) Appl. No.: **29/405,950**

(22) Filed: **Nov. 8, 2011**

(51) **LOC (9) Cl.** **21-02**

(52) **U.S. Cl.** **D21/809; D21/803**

(58) **Field of Classification Search** D21/769-770,
D21/801, 803, 809; 114/253, 345-346; 441/35,
441/66, 40-42, 129-132; 472/128-129;
D12/5, 6, 316

See application file for complete search history.

(56) **References Cited**

U.S. PATENT DOCUMENTS

D341,866 S	*	11/1993	Ross	D21/803
D400,624 S	*	11/1998	Hornsby et al.	D21/769
D457,589 S	*	5/2002	Friar	D21/808
D480,442 S	*	10/2003	Peterson	D21/770
D480,443 S	*	10/2003	Peterson	D21/770
D489,426 S	*	5/2004	Oakley	D21/803

D496,976 S	*	10/2004	Peterson	D21/770
D517,631 S	*	3/2006	Peterson	D21/770
D554,223 S	*	10/2007	Peterson	D21/803
D580,006 S	*	11/2008	Peterson	D21/809

* cited by examiner

Primary Examiner — Zenia Bennett

(74) *Attorney, Agent, or Firm* — Suiter Swantz pc llo

(57) **CLAIM**

The ornamental design for an inflatable towable vehicle, as shown and described.

DESCRIPTION

FIG. 1 is a perspective view of the inflatable towable vehicle showing the footrest in the retracted position;

FIG. 2 is a perspective view showing the footrest in the extended position;

FIG. 3 is a left side elevational view thereof;

FIG. 4 is a right side elevational view thereof;

FIG. 5 is a front elevational view thereof;

FIG. 6 is a rear elevational view thereof;

FIG. 7 is a top plan view thereof; and,

FIG. 8 is a bottom plan view thereof.

1 Claim, 6 Drawing Sheets

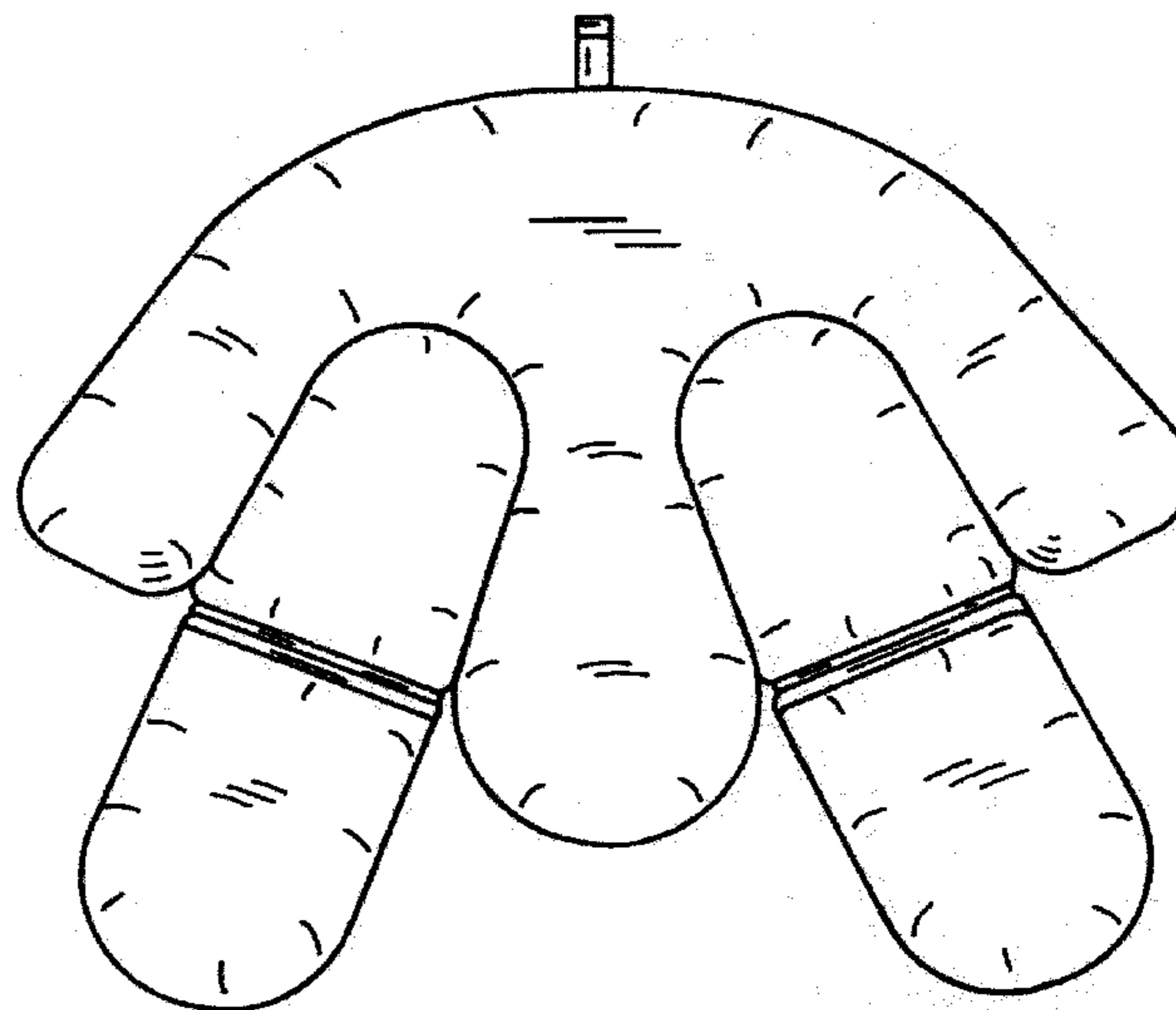
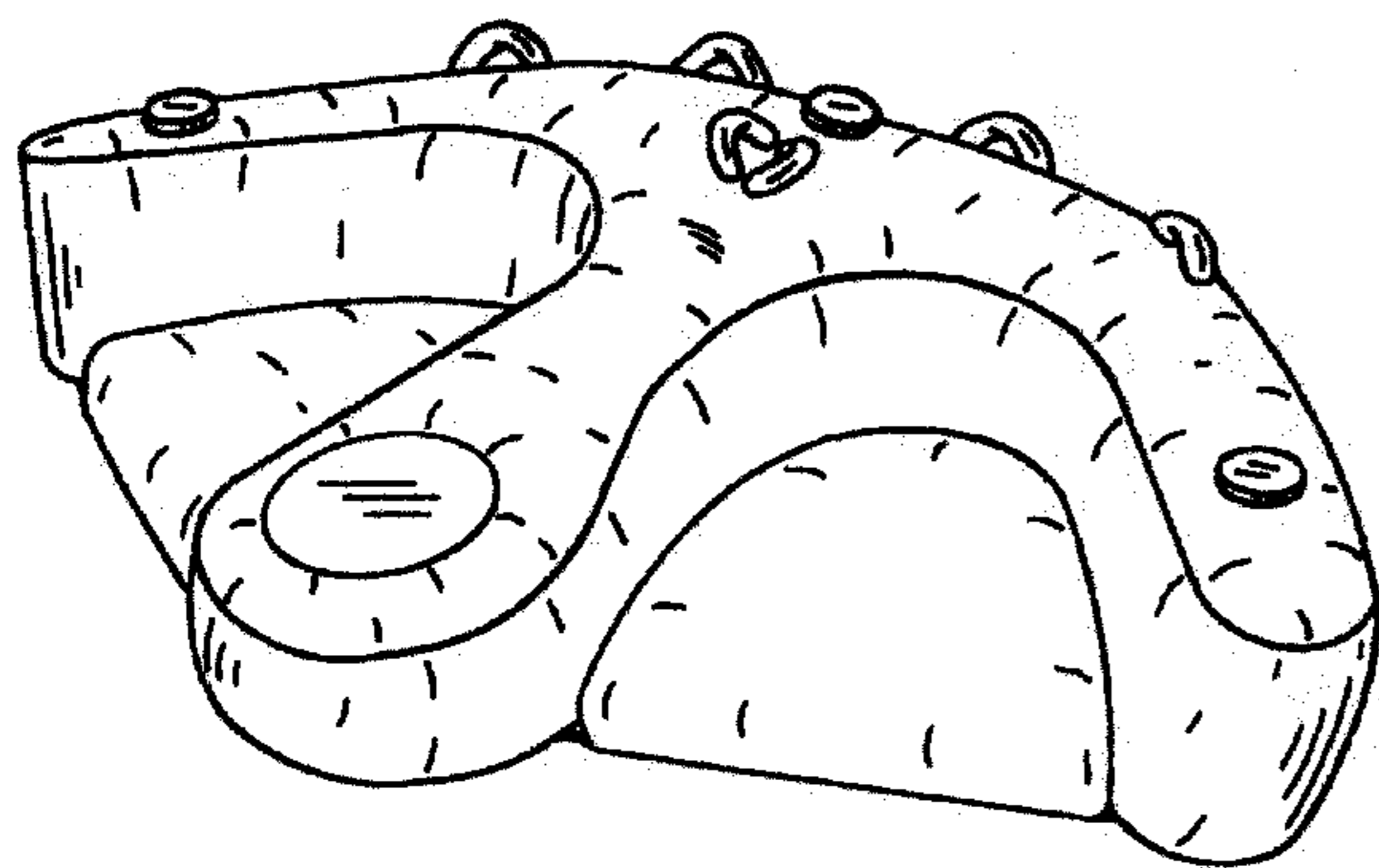

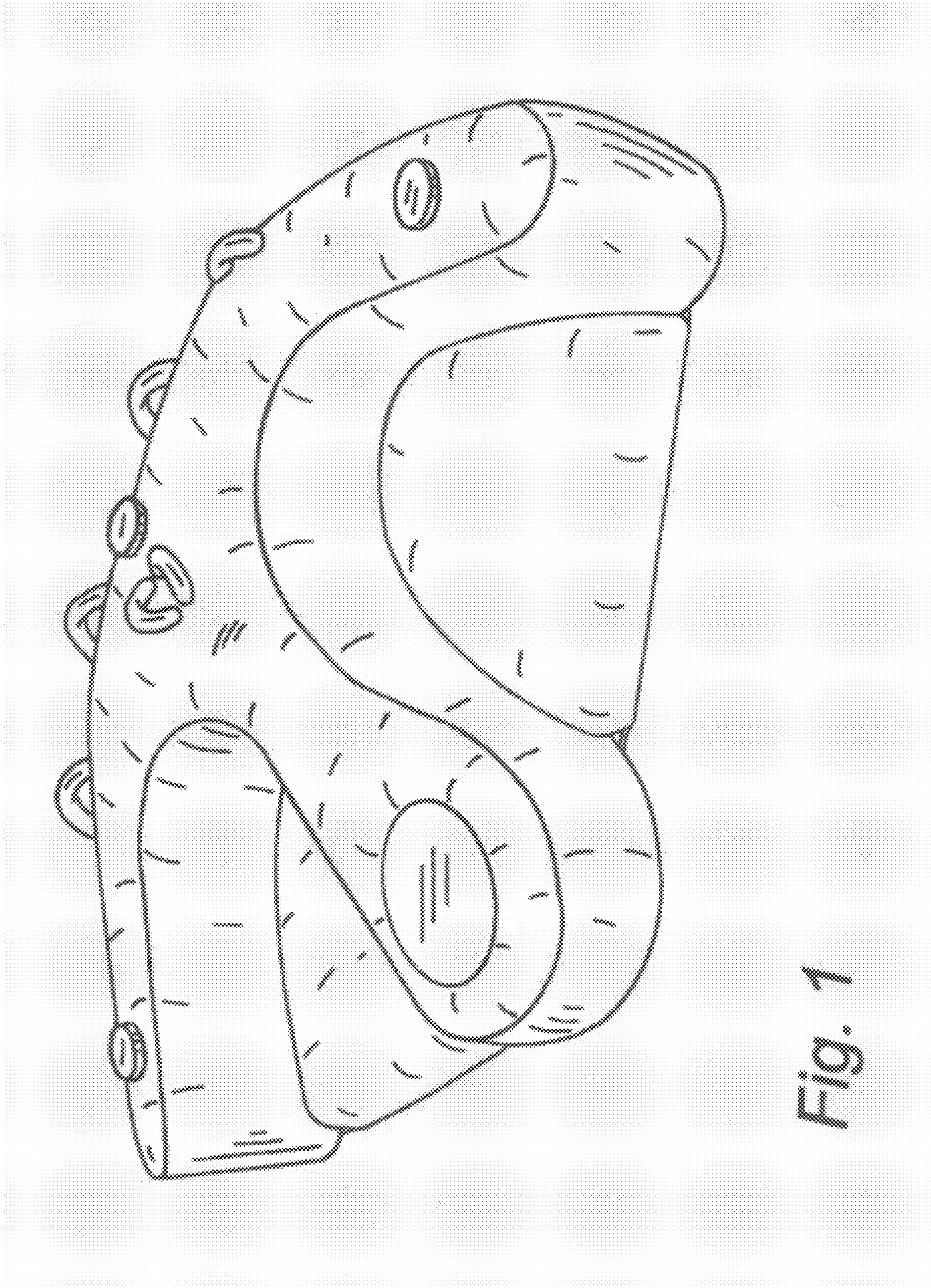

Fig. 1

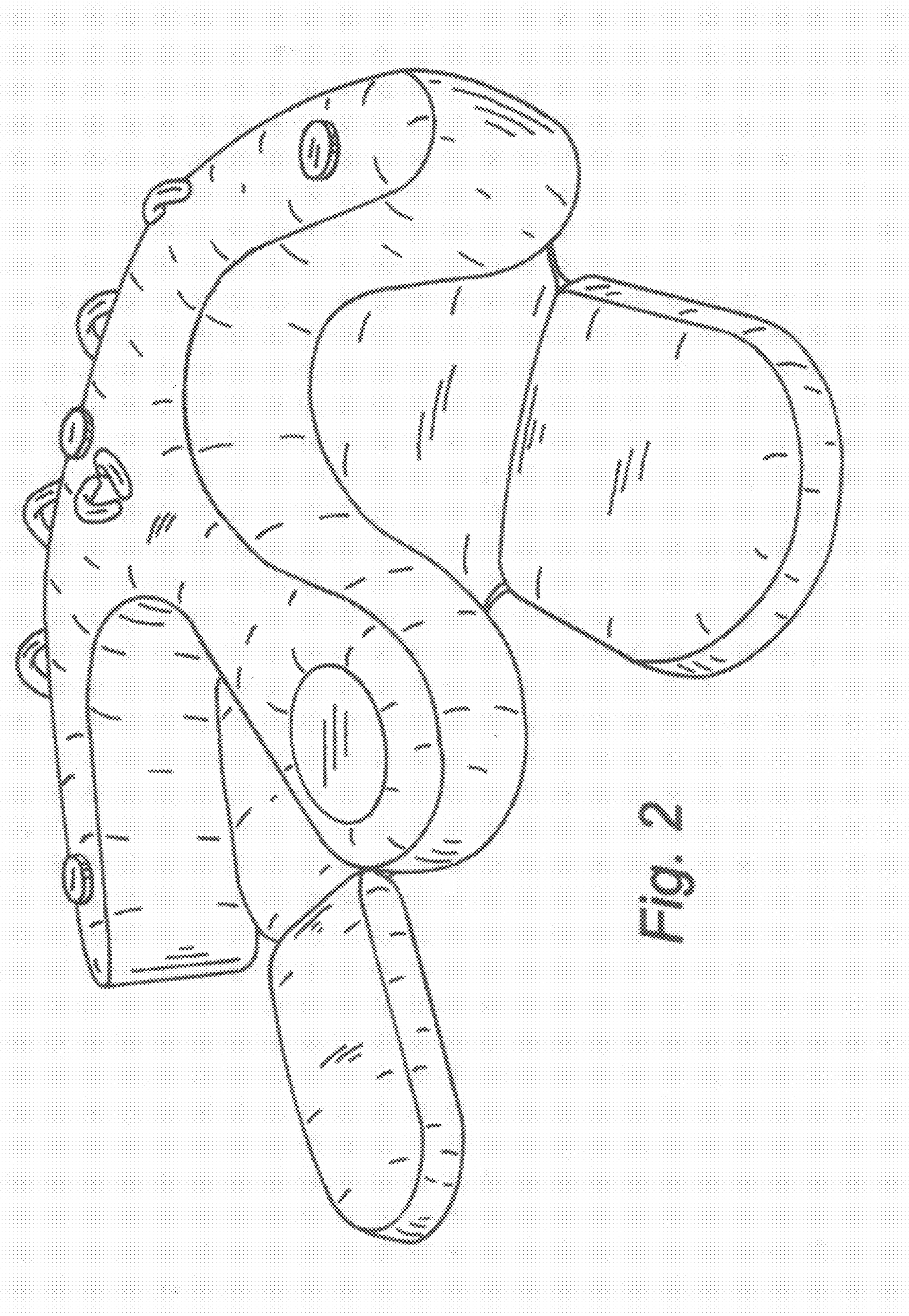

Fig. 2

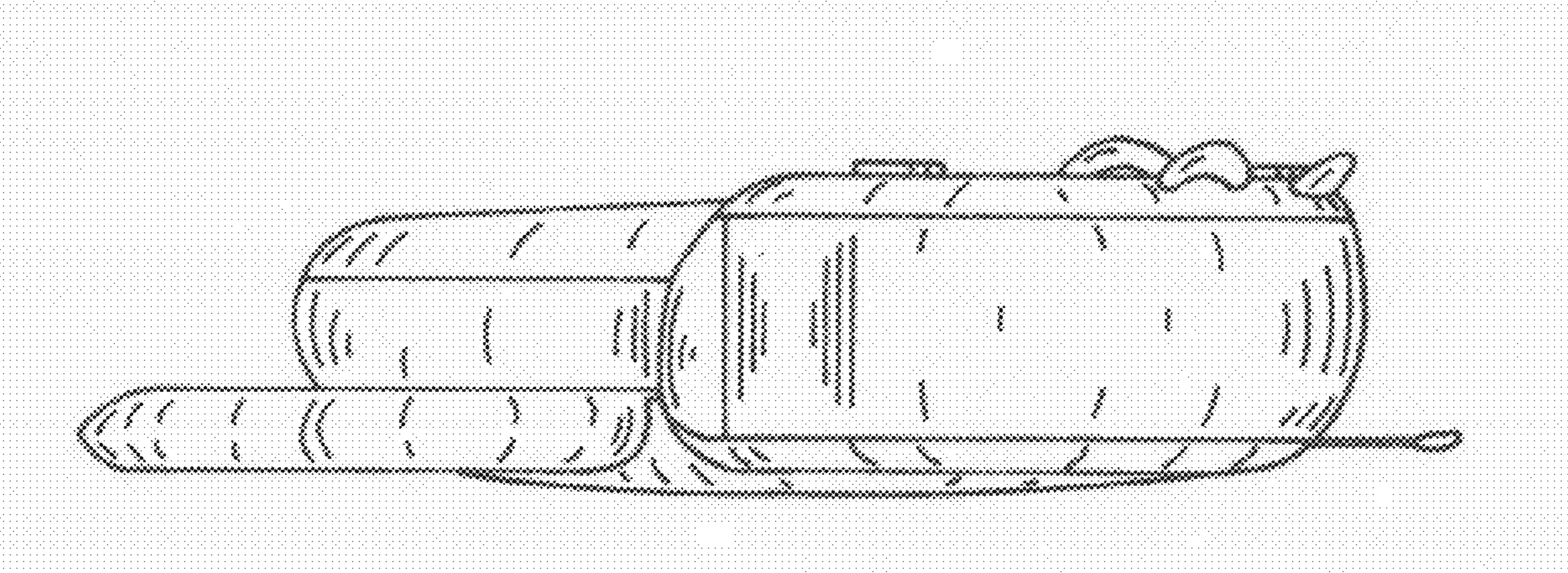

Fig. 3

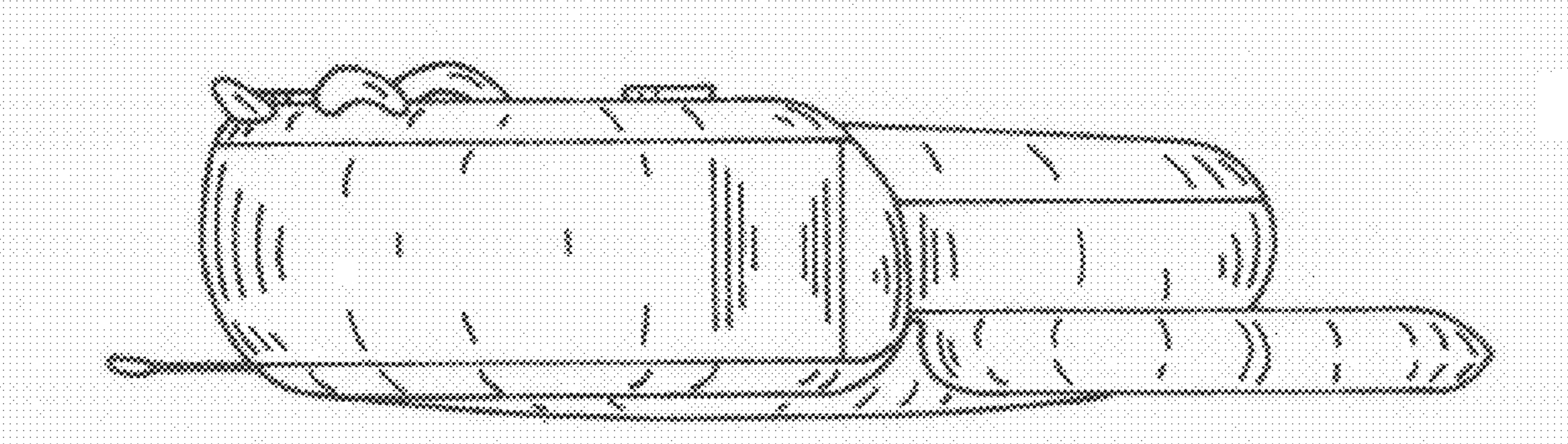

Fig. 4

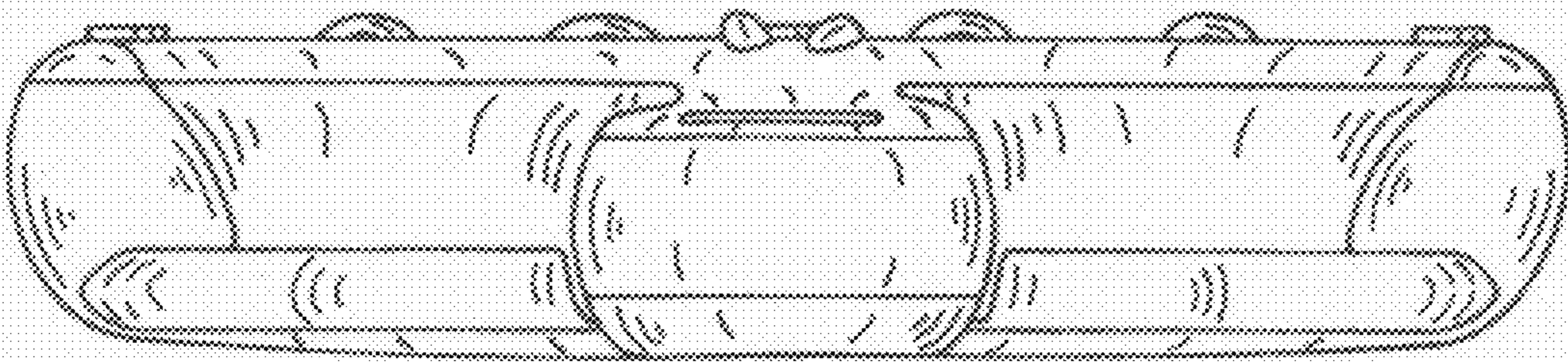

Fig. 5

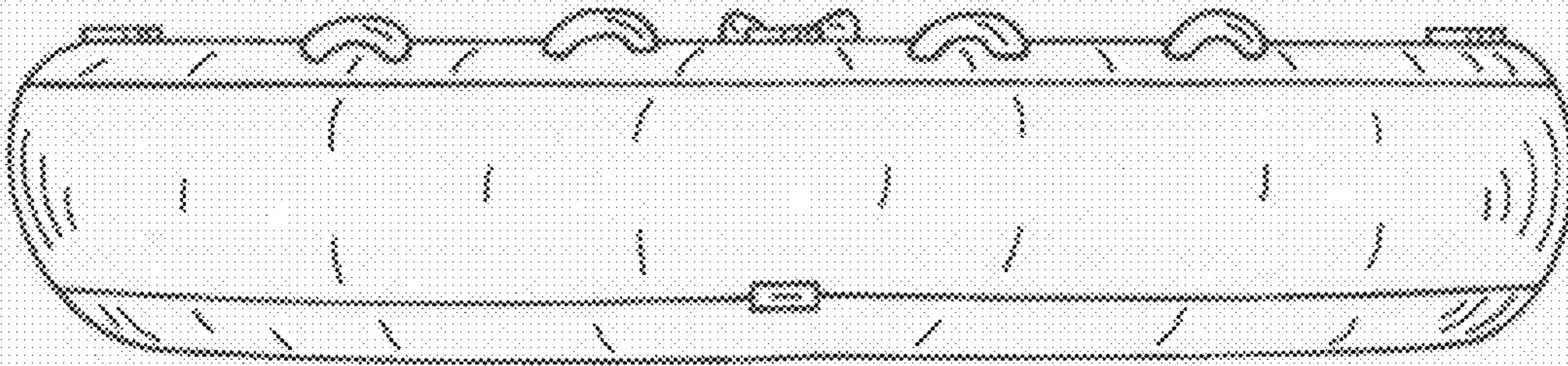

Fig. 6

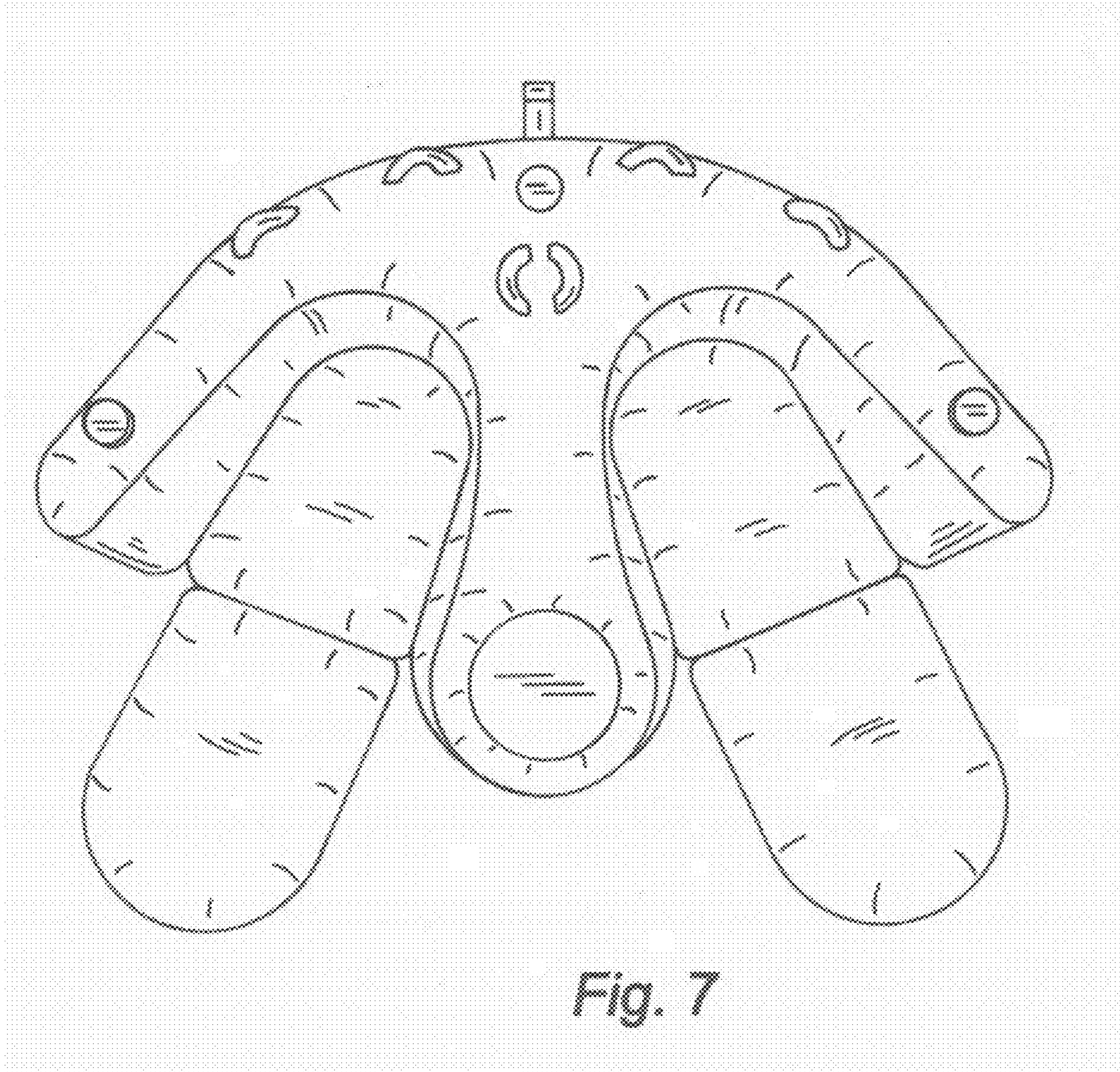

Fig. 7

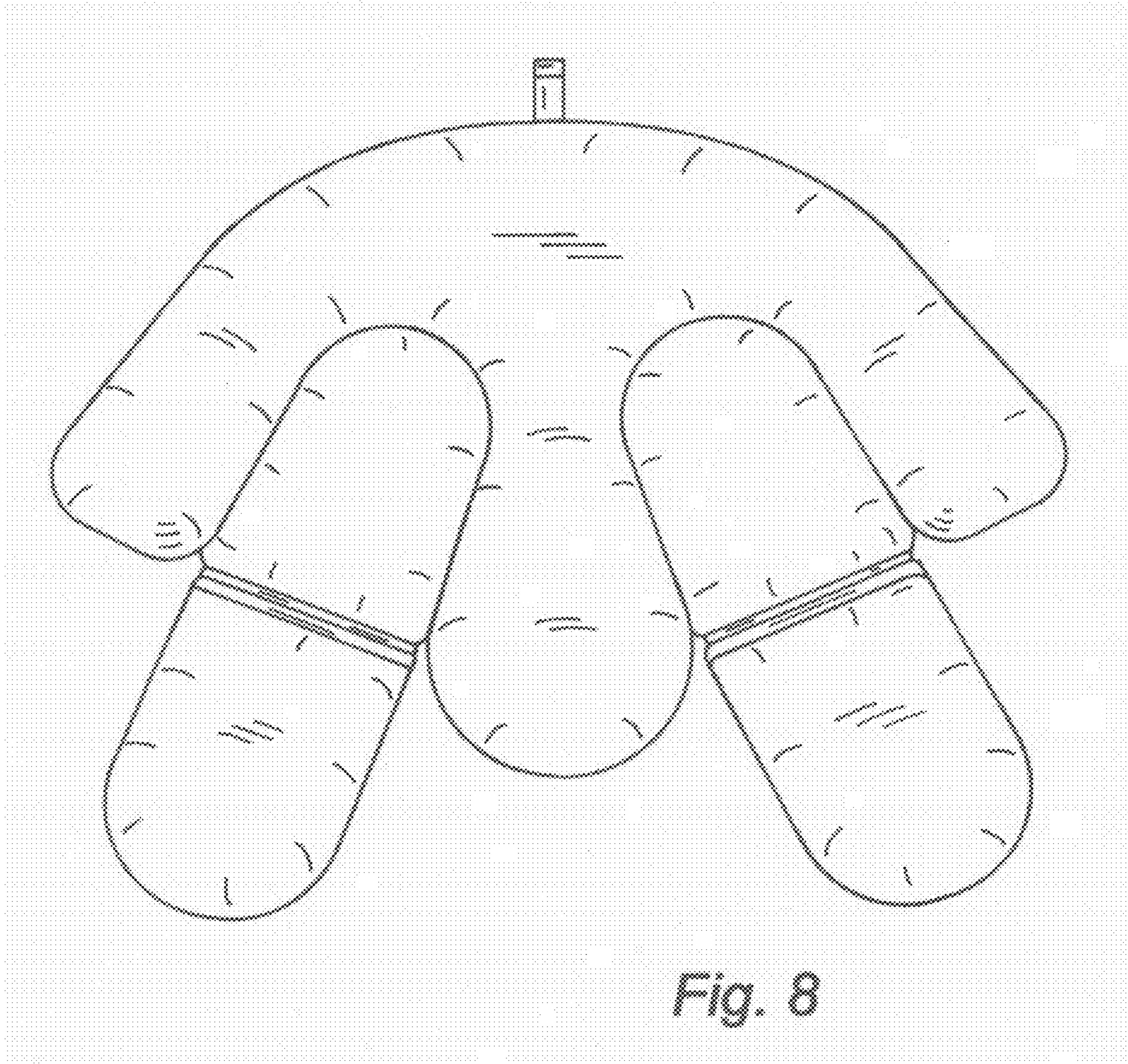

Fig. 8