

US00D662485S

(12) **United States Design Patent**
Han

(10) **Patent No.:** **US D662,485 S**

(45) **Date of Patent:** **** *Jun. 26, 2012**

(54) **MOBILE PHONE**

(75) Inventor: **Woo-Seung Han**, Seoul (KR)

(73) Assignee: **Samsung Electronics Co., Ltd.**,
Suwon-Si (KR)

(*) Notice: This patent is subject to a terminal disclaimer.

(**) Term: **14 Years**

(21) Appl. No.: **29/394,027**

(22) Filed: **Jun. 13, 2011**

(30) **Foreign Application Priority Data**

Apr. 11, 2011 (KR) 30-2011-0014554

(51) **LOC (9) Cl.** **14-03**

(52) **U.S. Cl.** **D14/138 AB**

(58) **Field of Classification Search** D14/138 AB,
D14/138 AA, 496, 341, 345, 346, 203.3,
D14/203.4, 203.7, 138 AD, 138 R, 147, 218,
D14/137; 455/575.1, 556.2, 575.3, 575.4;
D21/517; 379/433.01, 433.04, 433.11, 433.12,
379/433.13

See application file for complete search history.

(56) **References Cited**

U.S. PATENT DOCUMENTS

D486,132 S * 2/2004 Jang D14/138 AB
6,975,273 B1 * 12/2005 Choi 343/702
D563,365 S * 3/2008 Kim D14/138 AB
D578,979 S * 10/2008 Choi et al. D14/138 AB
D580,901 S * 11/2008 Su et al. D14/138 AB
D584,280 S * 1/2009 Moon et al. D14/138 AB
D585,408 S * 1/2009 Kim et al. D14/138 AB
D593,050 S * 5/2009 Kim et al. D14/138 R

D593,986 S * 6/2009 Chen et al. D14/138 AB
D598,411 S * 8/2009 Chun D14/138 AB
D622,255 S * 8/2010 Lee et al. D14/138 AB
D624,516 S * 9/2010 Hachiya D14/138 AB
D630,178 S * 1/2011 Lee et al. D14/138 AB
D630,180 S * 1/2011 Kim et al. D14/138 AB
D633,069 S * 2/2011 Ryu et al. D14/138 AB
D635,116 S * 3/2011 Lee et al. D14/138 AB
D635,539 S * 4/2011 Suk et al. D14/138 AB

(Continued)

OTHER PUBLICATIONS

Samsung B300 telephone, announced Jul. 2008, [online], [site visited Aug. 10, 2011]. Available from Internet, <URL: <http://www.gsmarena.com>>.*

(Continued)

Primary Examiner — Jeffrey D Asch

(74) *Attorney, Agent, or Firm* — Staas & Halsey LLP

(57) **CLAIM**

The ornamental design for a mobile phone, as shown and described.

DESCRIPTION

FIG. 1 is a front perspective view of a mobile phone;
FIG. 2 is a front view of the mobile phone of FIG. 1;
FIG. 3 is a rear view of the mobile phone of FIG. 1;
FIG. 4 is a left-side view of the mobile phone of FIG. 1;
FIG. 5 is a right-side view of the mobile phone of FIG. 1;
FIG. 6 is a top plan view of the mobile phone of FIG. 1;
FIG. 7 is a bottom plan view of the mobile phone of FIG. 1;
FIG. 8 is another front perspective view of the mobile phone of FIG. 1 when the power is on; and,
FIG. 9 is an open front perspective view of the mobile phone of FIG. 1.

1 Claim, 9 Drawing Sheets

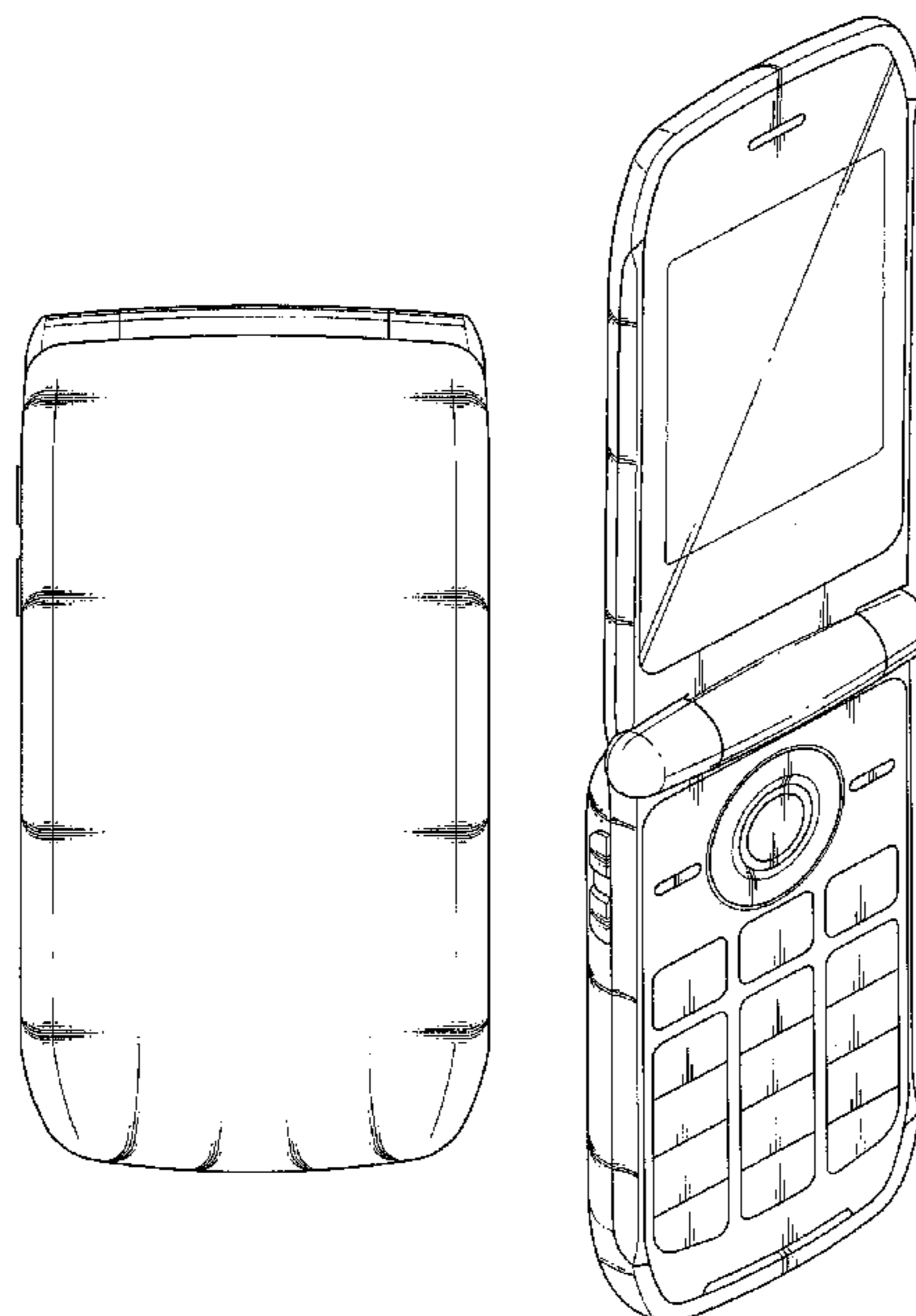

US D662,485 S

Page 2

U.S. PATENT DOCUMENTS

D635,542 S * 4/2011 Park et al. D14/138 AB
D635,953 S * 4/2011 Kim D14/138 AB
2005/0272462 A1* 12/2005 Okamoto 455/550.1
2006/0148542 A1* 7/2006 Oliver 455/575.3
2009/0007380 A1* 1/2009 Feng et al. 16/305
2010/0167693 A1* 7/2010 Yamada 455/411

OTHER PUBLICATIONS

Samsung R260 Chrono telephone, announced May 2011, [online], [site visited Aug. 10, 2011]. Available from Internet, <URL: <http://www.gsmarena.com>>.*

Samsung E2530 telephone, announced Nov. 2010, [online], [site visited Aug. 10, 2011]. Available from Internet, <URL: <http://www.gsmarena.com>>.*

LG KH3900 Joypop telephone, announced Apr. 2010, [online], [site visited Aug. 10, 2011]. Available from Internet, <URL: <http://www.gsmarena.com>>.*

Samsung A500 telephone, announced 2002, [online], [site visited Aug. 10, 2011]. Available from Internet, <URL: <http://www.gsmarena.com>>.*

LG KF350 telephone, announced Aug. 2008, [online], [site visited Aug. 10, 2011]. Available from Internet, <URL: <http://www.gsmarena.com>>.*

LG MG295 telephone, announced Jan. 2008, [online], [site visited Aug. 10, 2011]. Available from Internet, <URL: <http://www.gsmarena.com>>.*

* cited by examiner

FIG. 1

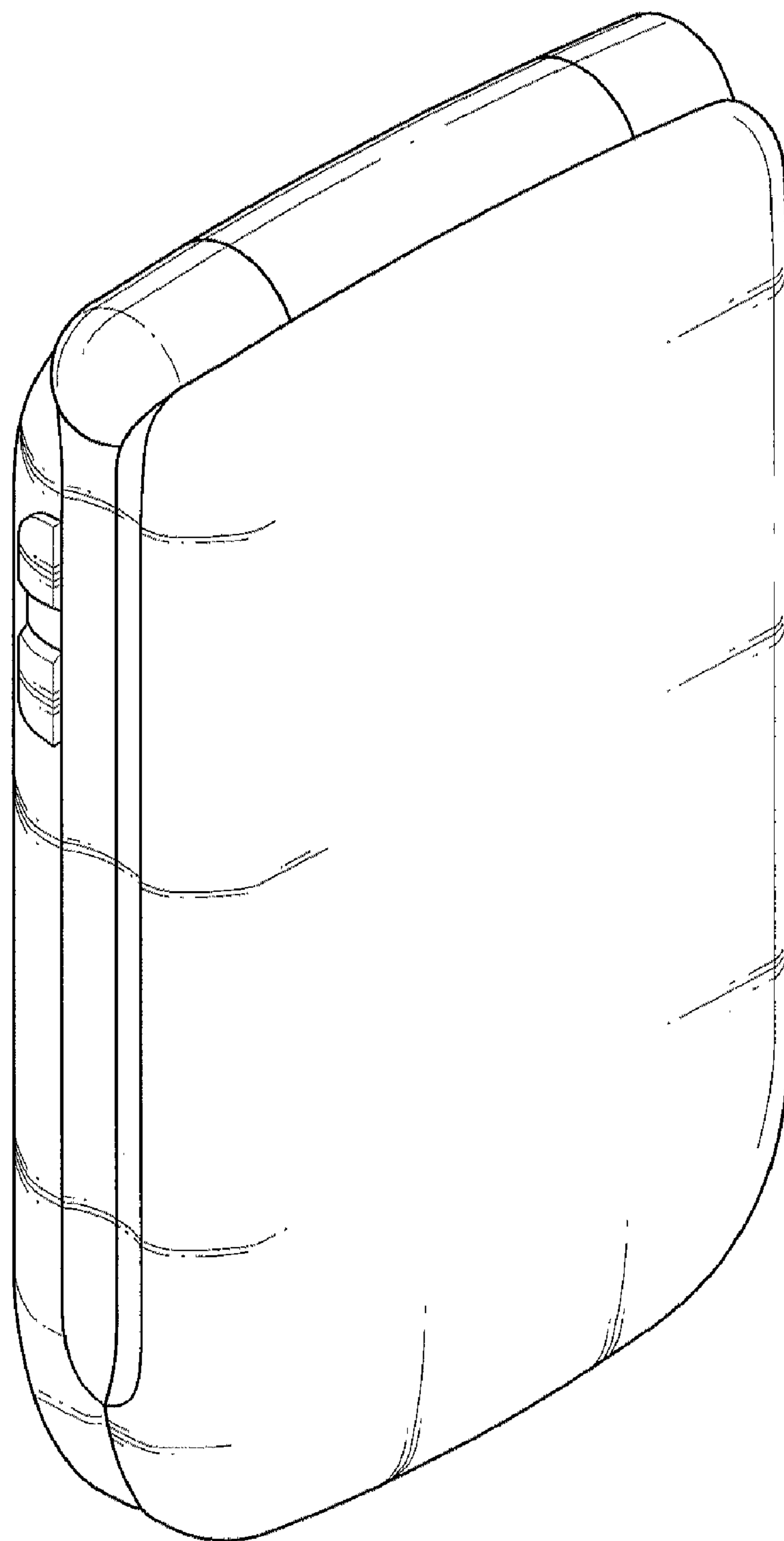

FIG. 2

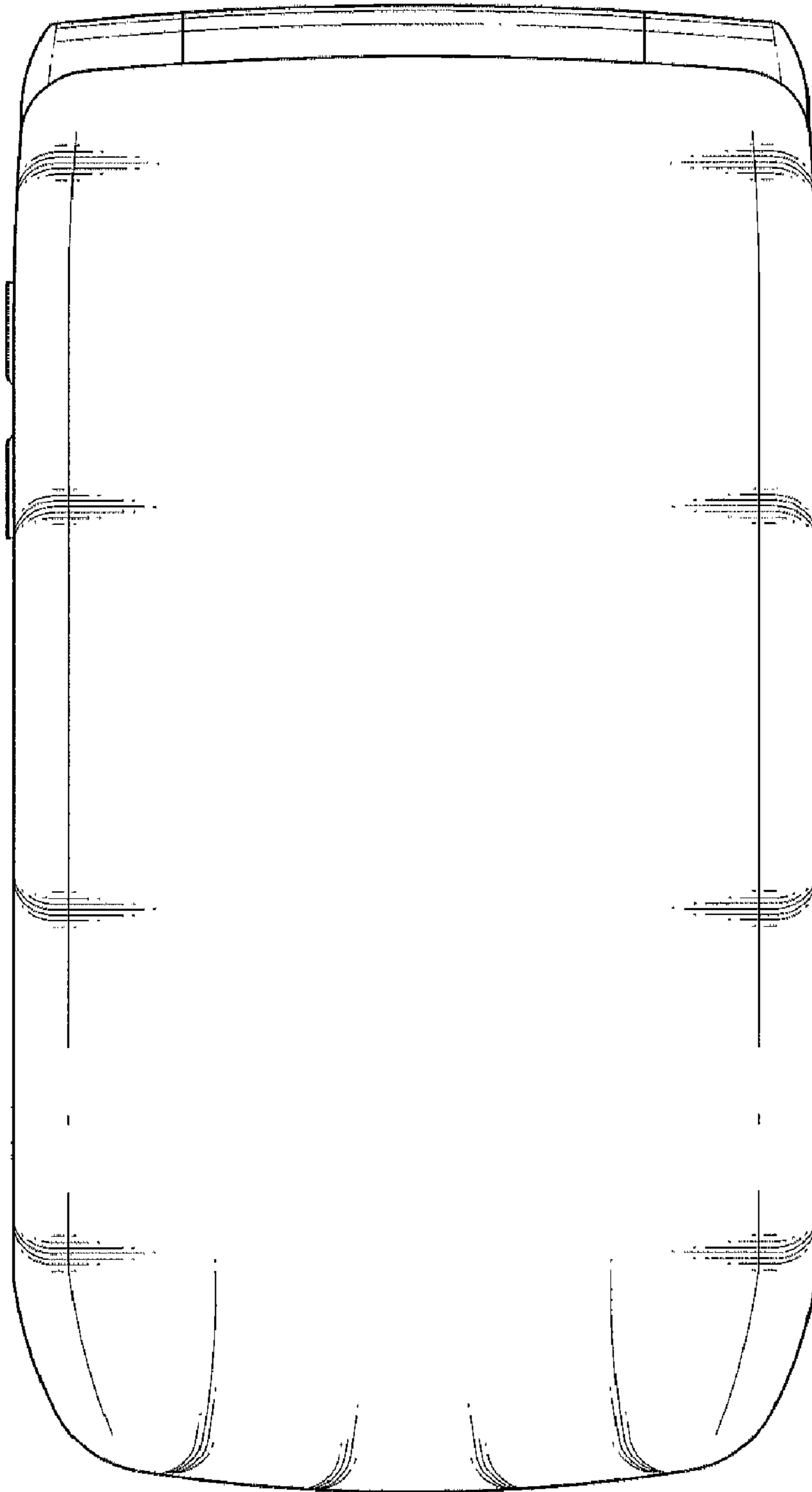

FIG. 3

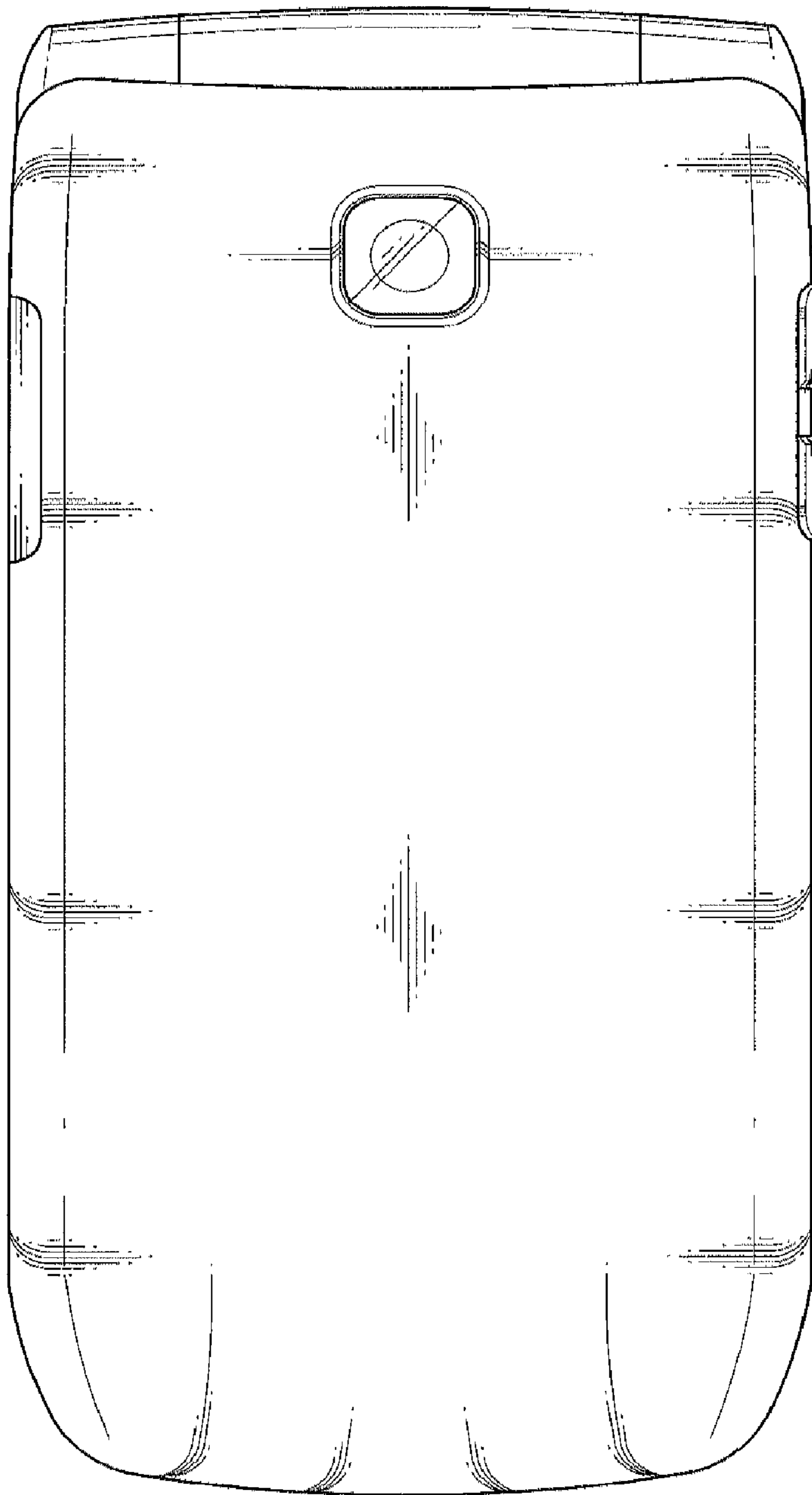

FIG. 4

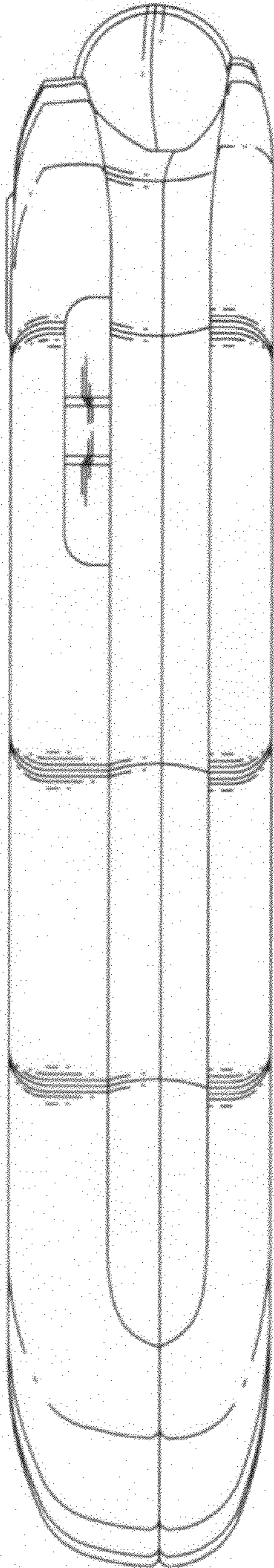

FIG. 5

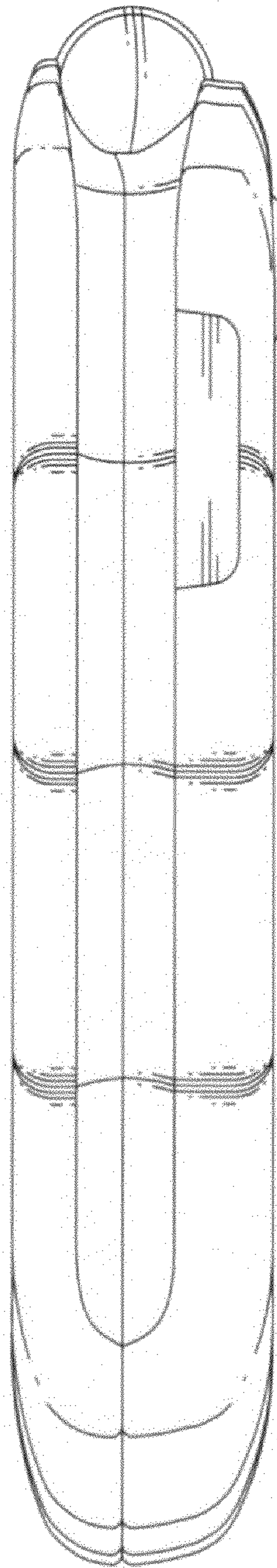

FIG. 6

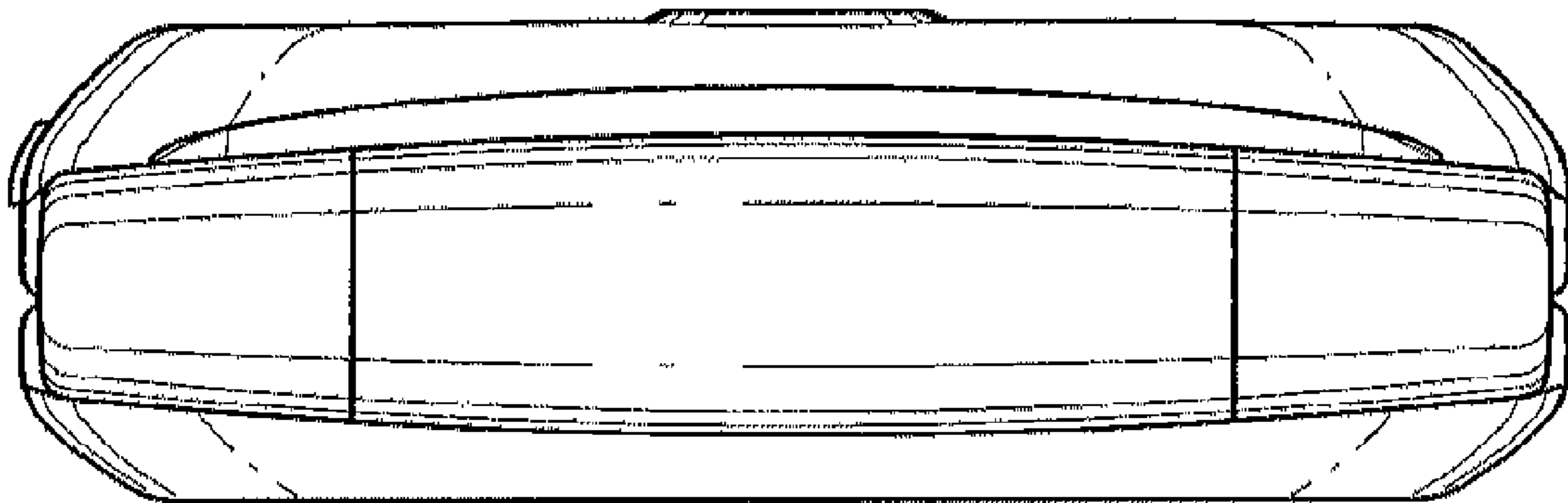

FIG. 7

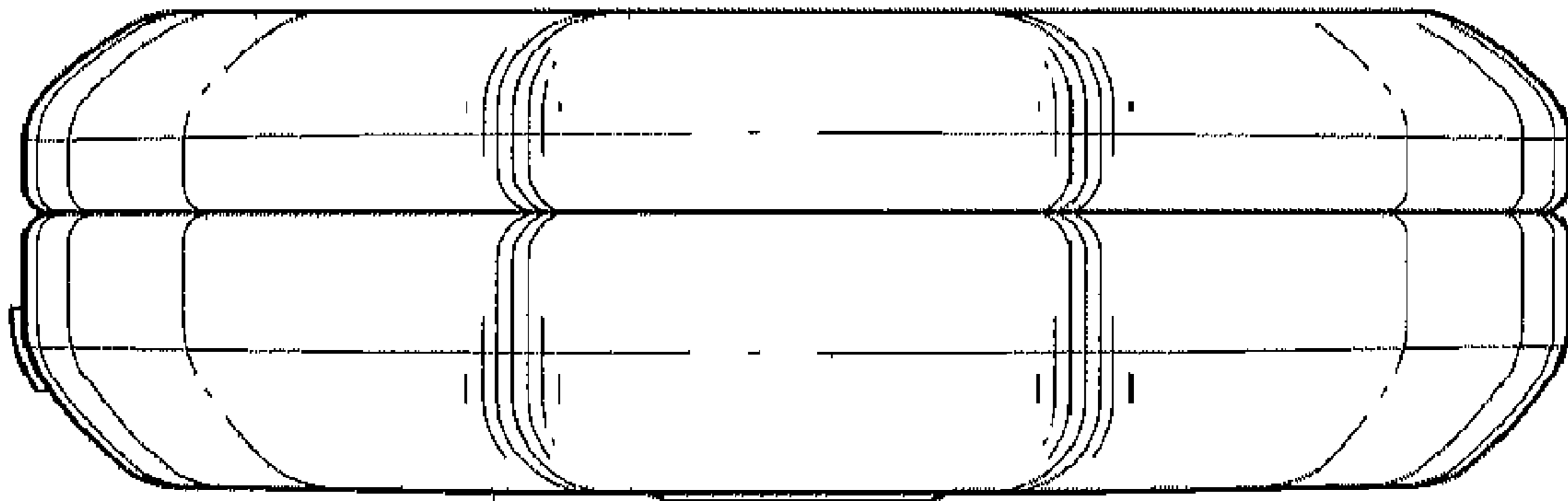

FIG. 8

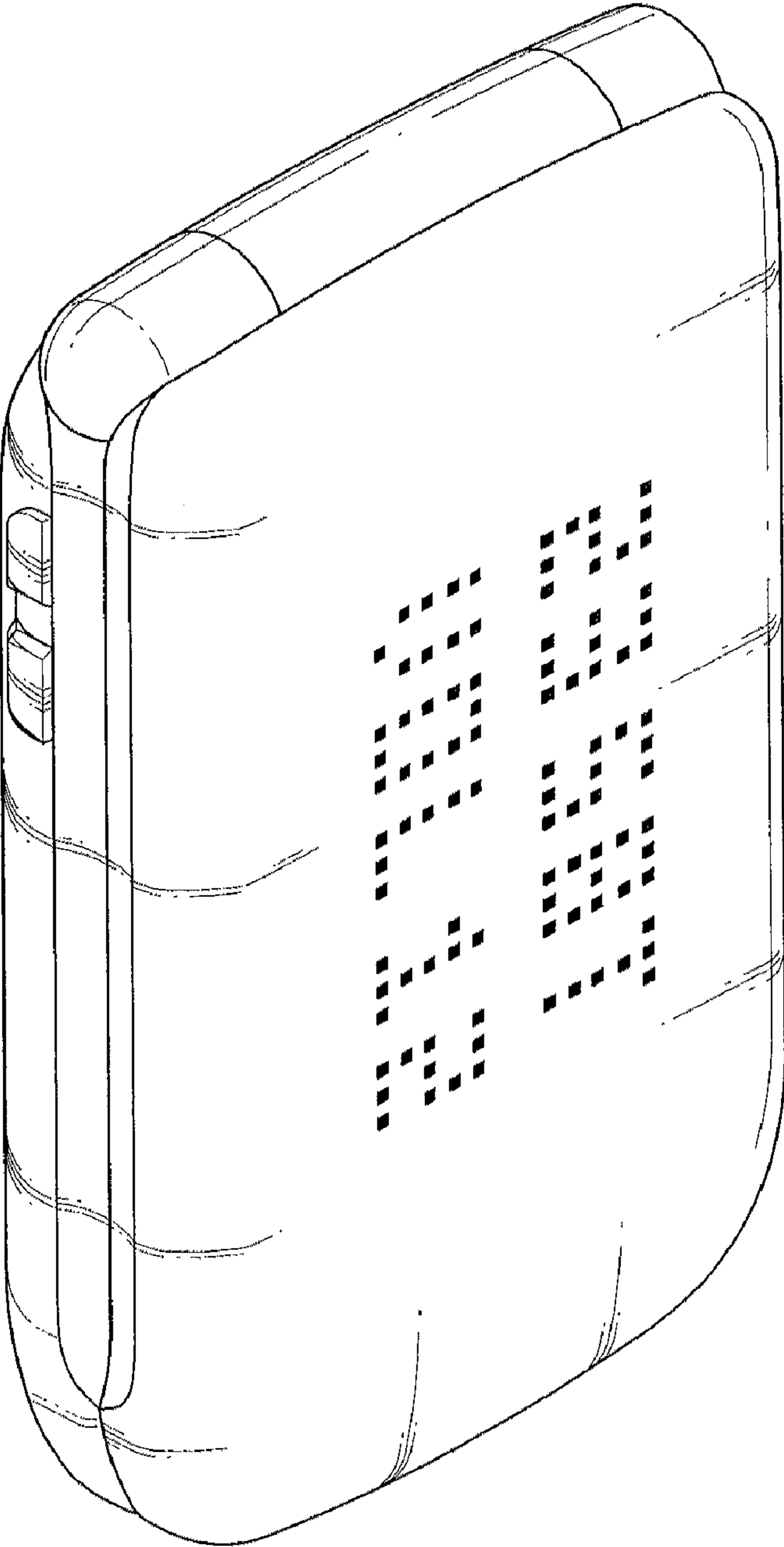

FIG. 9

