



US00D662472S

(12) **United States Design Patent**  
**Tien**

(10) **Patent No.:** **US D662,472 S**

(45) **Date of Patent:** **\*\* Jun. 26, 2012**

(54) **POWER PLUG**

(75) Inventor: **Li-Wen Tien**, New Taipei (TW)

(73) Assignee: **Hon Hai Precision Industry Co., Ltd.**,  
Tu-Cheng, New Taipei (TW)

(\*\*) Term: **14 Years**

(21) Appl. No.: **29/402,210**

(22) Filed: **Sep. 21, 2011**

(51) **LOC (9) Cl.** ..... **13-02**

(52) **U.S. Cl.** ..... **D13/110**

(58) **Field of Classification Search** ..... D13/110,  
D13/107, 108, 118, 119, 123, 133, 137.1,  
D13/184, 199; D14/251, 432, 434; 174/53,  
174/54, 59, 61; 307/11, 150, 151; 320/107,  
320/111, 112, 113, 114, 115; 361/679.01;  
363/142, 146; 439/131, 172, 626, 628, 638  
See application file for complete search history.

(56) **References Cited**

**U.S. PATENT DOCUMENTS**

D338,188	S	*	8/1993	Lee et al.	.....	D13/110
D350,113	S	*	8/1994	Nagele	.....	D13/110
5,613,863	A	*	3/1997	Klaus et al.	.....	439/131
5,973,948	A	*	10/1999	Hahn et al.	.....	363/146
D416,226	S	*	11/1999	Lohrding et al.	.....	D13/110
6,086,395	A	*	7/2000	Lloyd et al.	.....	439/172
D449,030	S	*	10/2001	Baxter et al.	.....	D13/110
D456,008	S	*	4/2002	Kawanobe et al.	.....	D13/110

6,669,495	B2	*	12/2003	Philips et al.	.....	439/170
D484,853	S	*	1/2004	Alviar	.....	D13/110
6,845,023	B2	*	1/2005	Philips et al.	.....	363/132
D562,766	S	*	2/2008	Yang et al.	.....	D13/110
D593,031	S	*	5/2009	Miyatake et al.	.....	D13/110

\* cited by examiner

*Primary Examiner* — Derrick Holland

(74) *Attorney, Agent, or Firm* — Altis Law Group, Inc.

(57) **CLAIM**

The ornamental design for a power plug, as shown and described.

**DESCRIPTION**

FIG. 1 is a front perspective view of a power plug showing my new design;  
 FIG. 2 is a front elevational view thereof;  
 FIG. 3 is a rear elevational view thereof, wherein two pins of the power plug (shown in broken lines) are in a retracted position;  
 FIG. 4 is a left side elevational view thereof;  
 FIG. 5 is a right side elevational view thereof;  
 FIG. 6 is a top plan view thereof;  
 FIG. 7 is a bottom plan view thereof; and,  
 FIG. 8 is a rear perspective view of the power plug of FIG. 1, wherein the two pins of the power plug (shown in broken lines) are in an extended position.  
 The broken lines of the figures are for the purpose of illustrating environment and form no part of the claimed design.

**1 Claim, 8 Drawing Sheets**

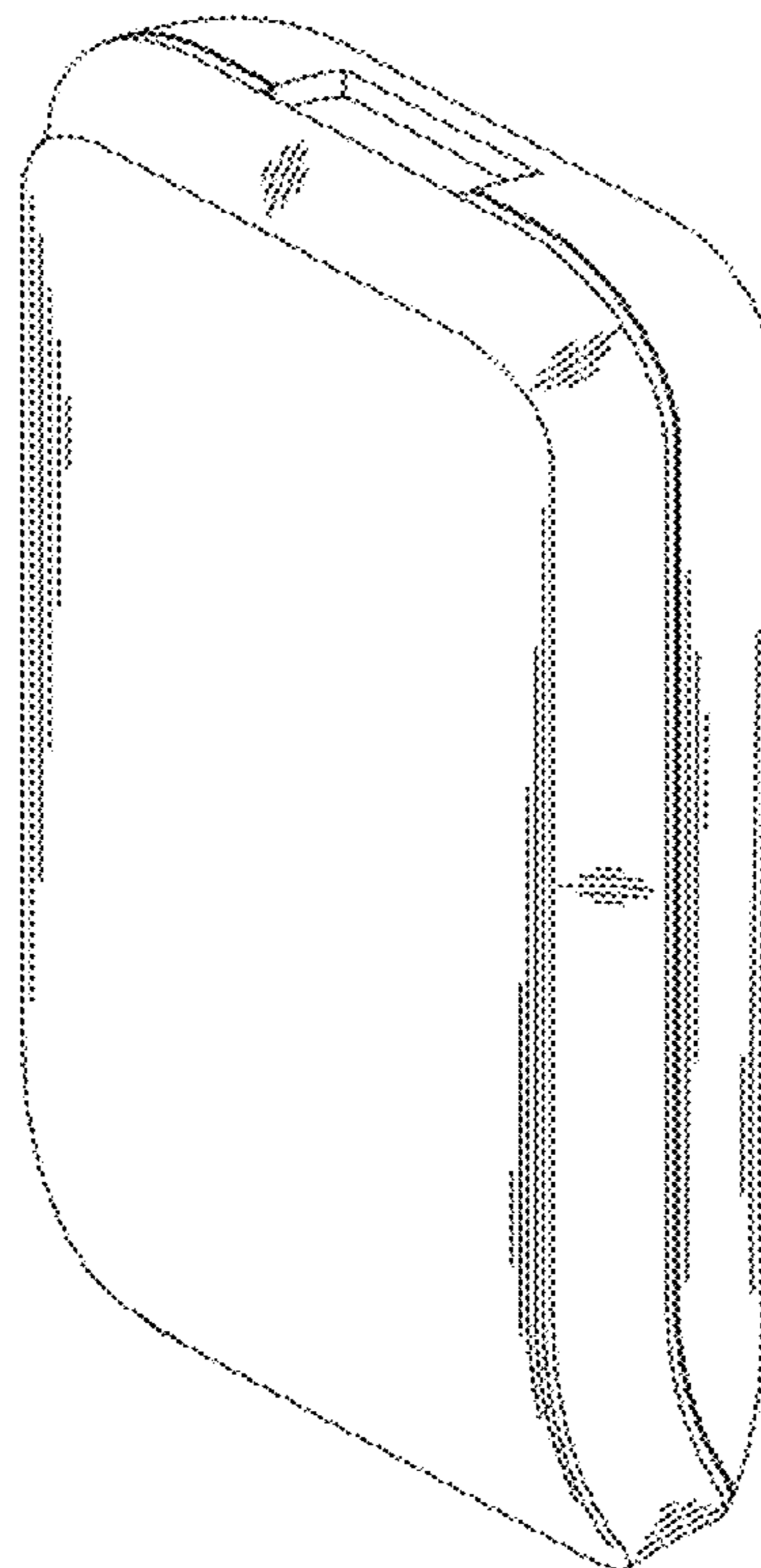

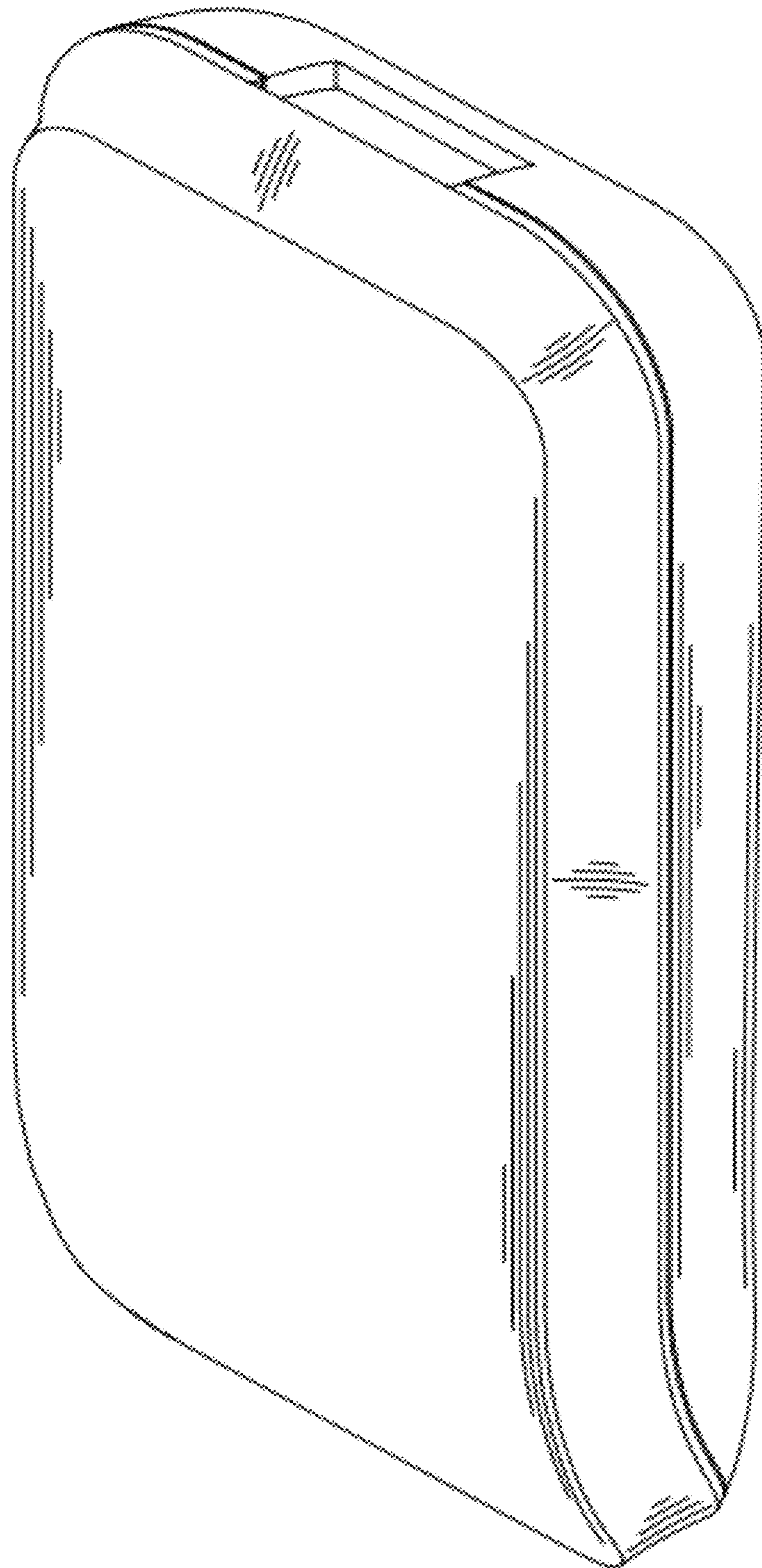

FIG. 1

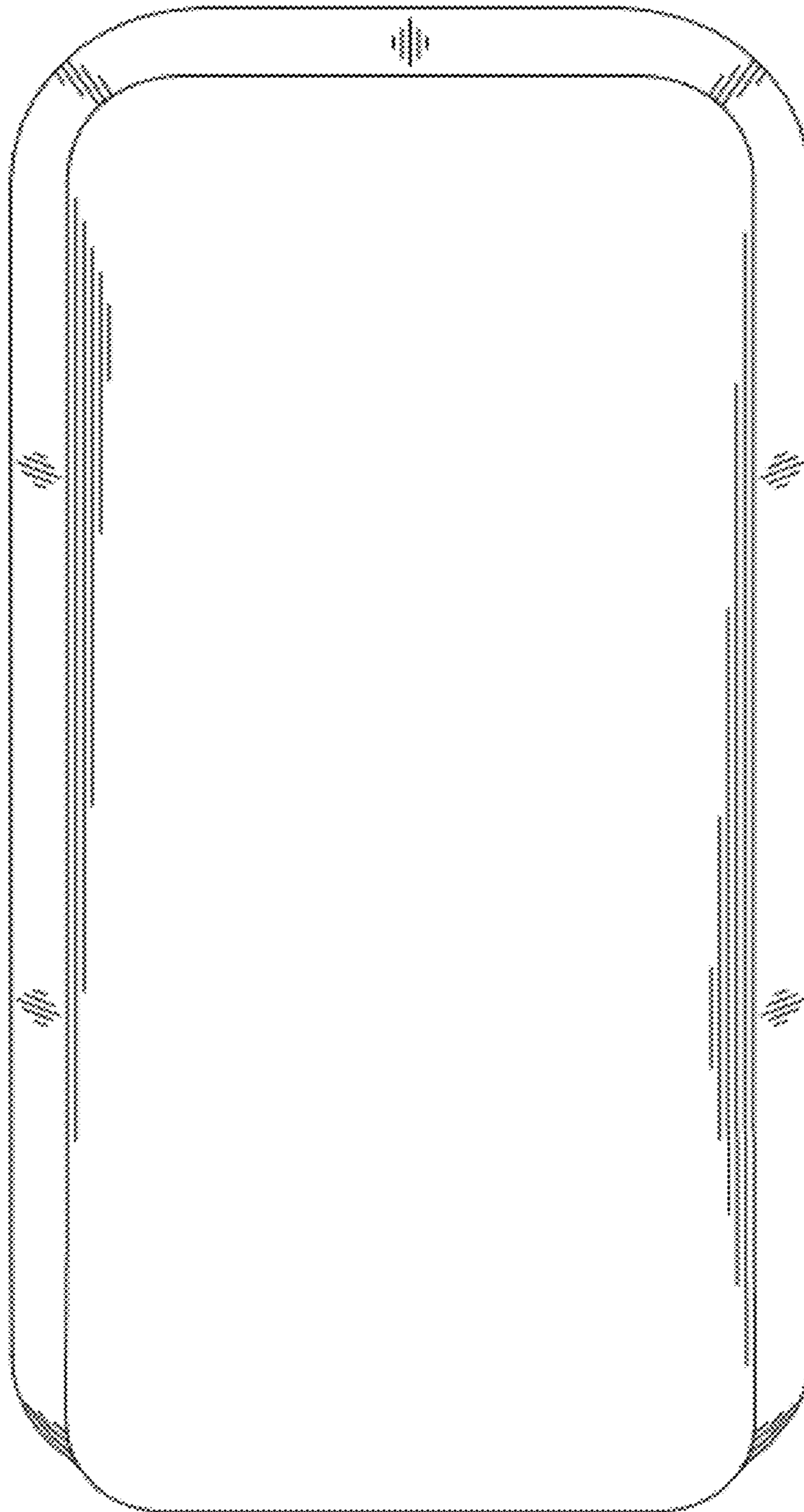

FIG. 2

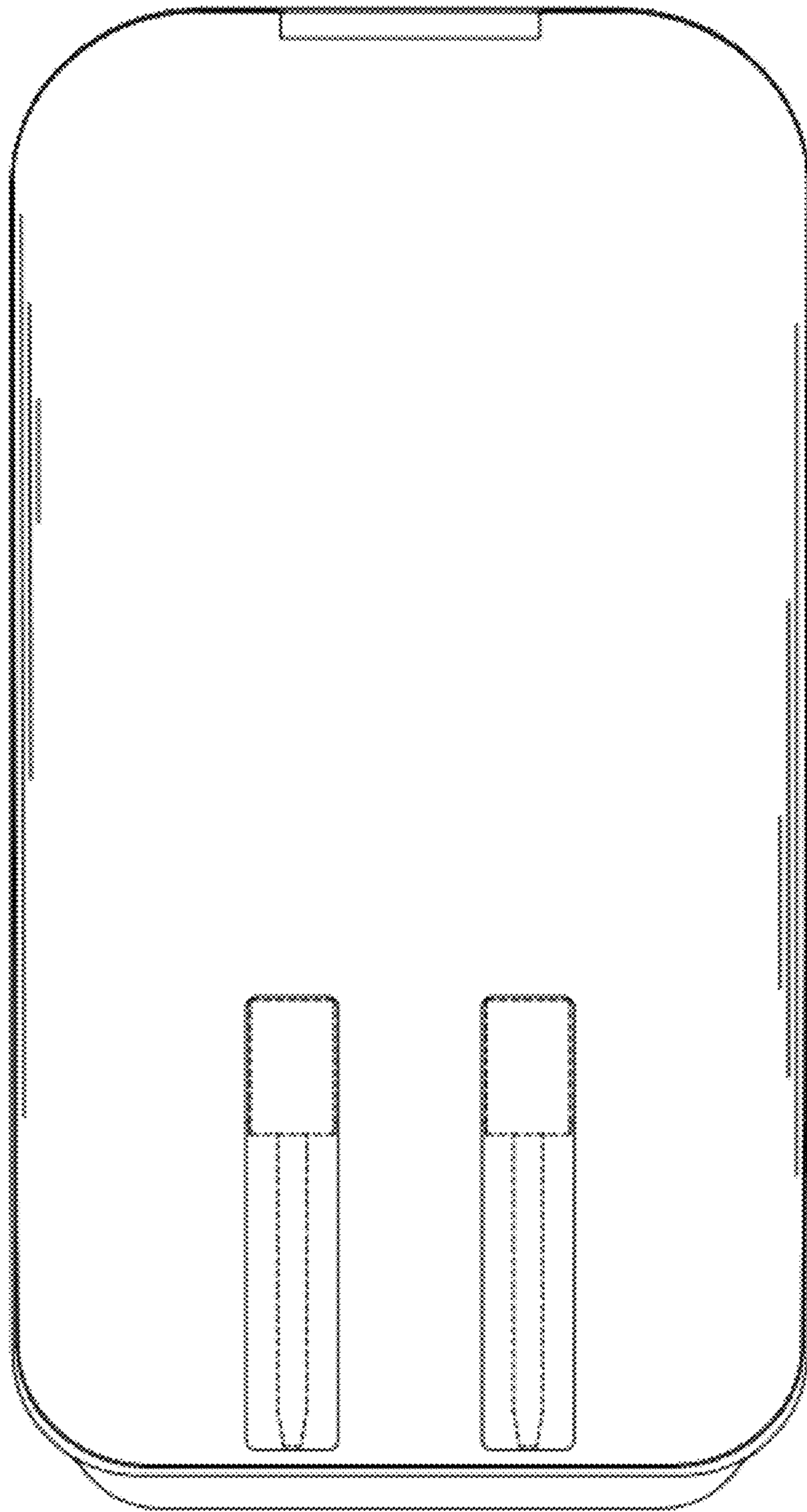

FIG. 3

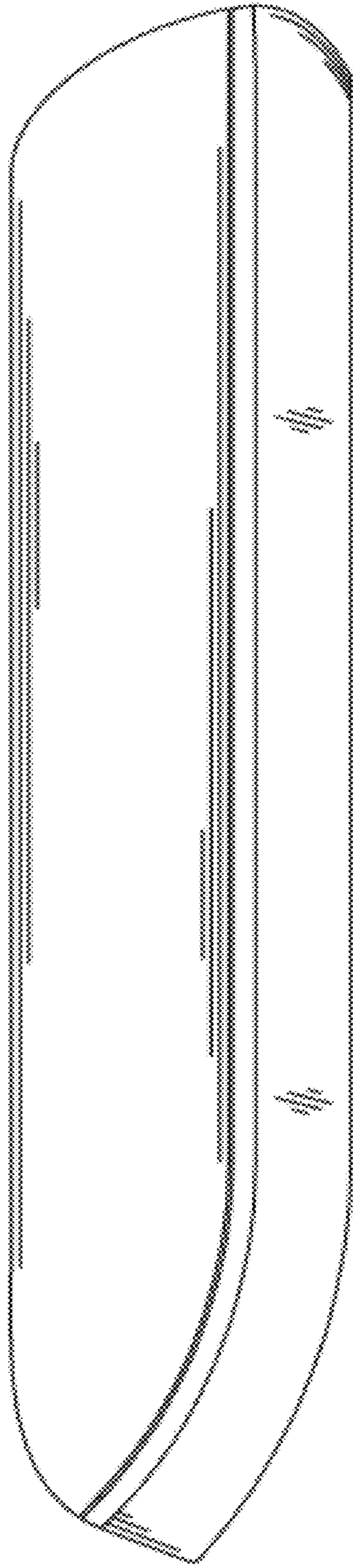

FIG. 4

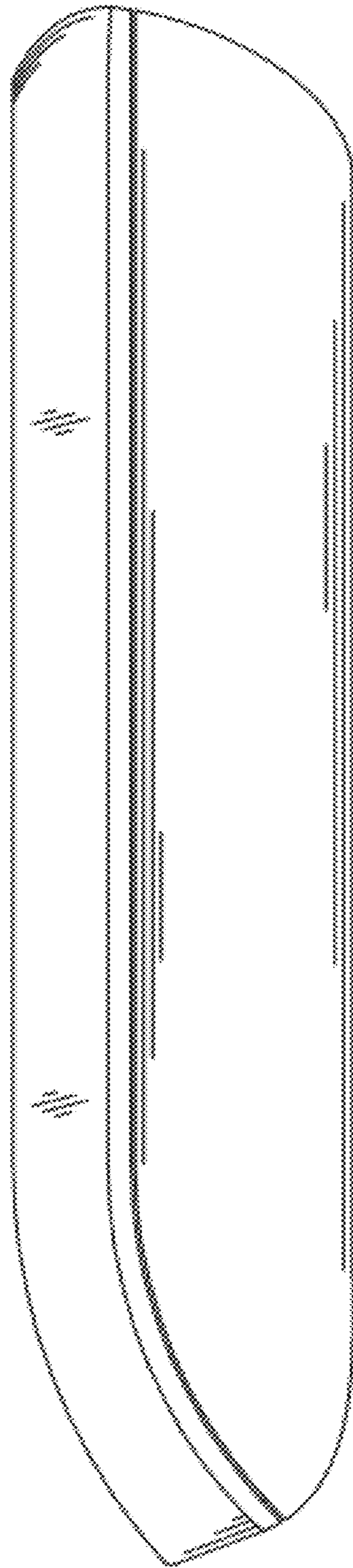

FIG. 5

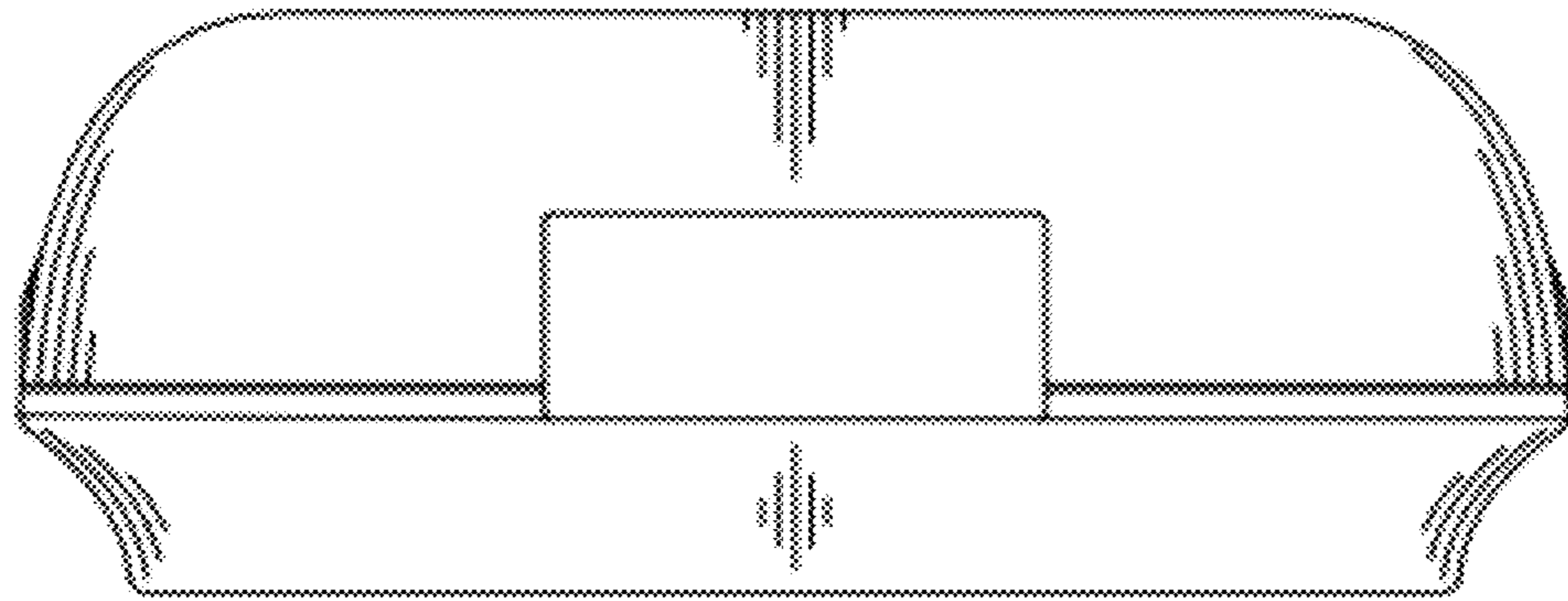

FIG. 6

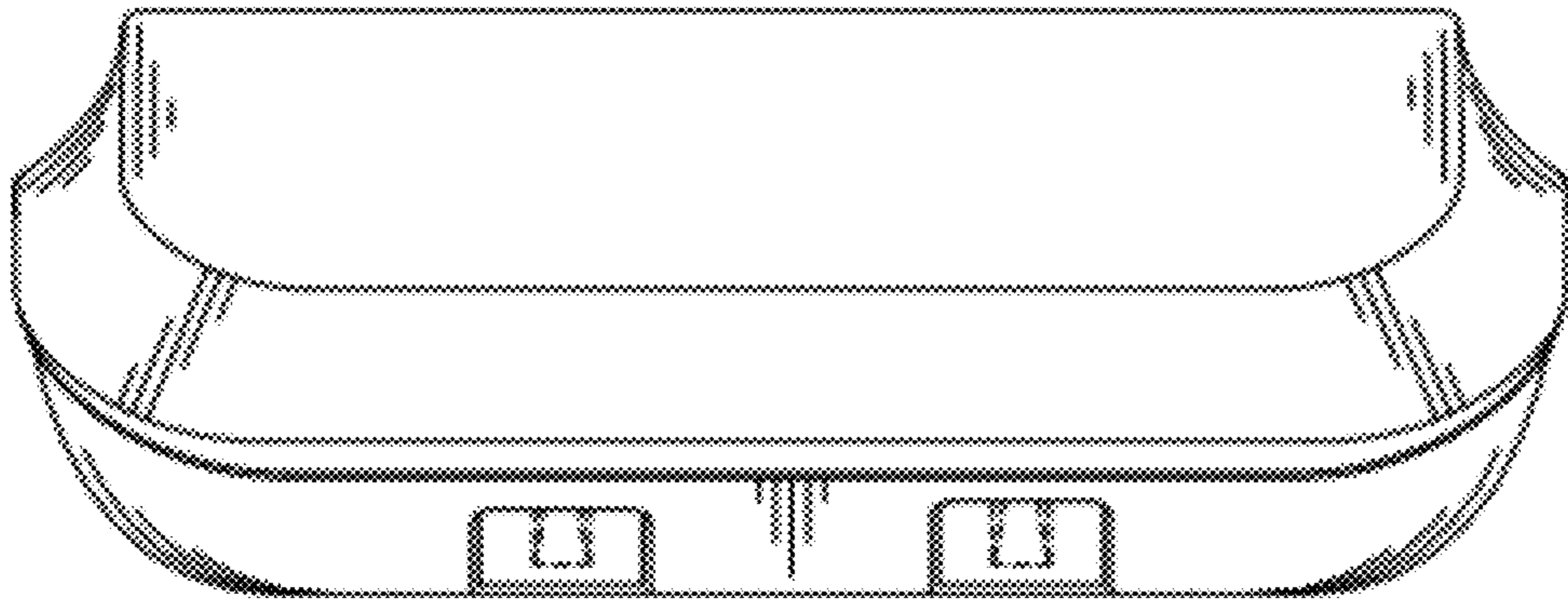

FIG. 7



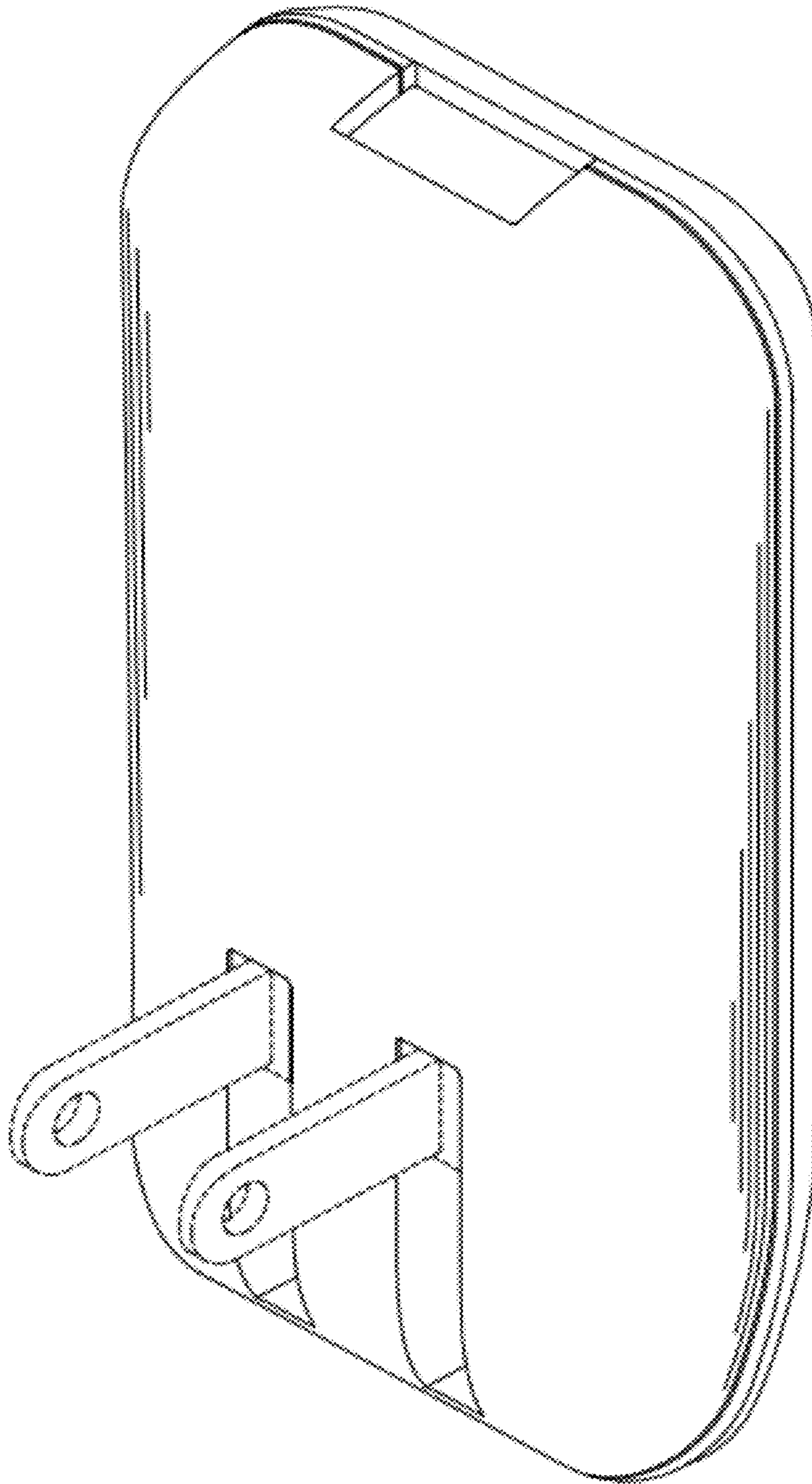

FIG. 8