



US00D662407S

(12) **United States Design Patent**
Mathur

(10) **Patent No.:** **US D662,407 S**
(45) **Date of Patent:** **** Jun. 26, 2012**

- (54) **SEISMIC TRANSITION JOINT CLIP FOR SUSPENSION CEILING SYSTEM**
- (75) Inventor: **Monika Mathur**, Conshohocken, PA (US)
- (73) Assignee: **Certainteed Corporation**, Valley Forge, PA (US)
- (**) Term: **14 Years**
- (21) Appl. No.: **29/408,629**
- (22) Filed: **Dec. 14, 2011**
- (51) **LOC (9) Cl.** **08-08**
- (52) **U.S. Cl.** **D8/394; D8/380**
- (58) **Field of Classification Search** D8/356, D8/371, 394-396, 380; 24/570; 248/74.2, 248/215, 227.1, 49, 300, 301, 316.7, 51, 248/489; D19/65, 56; 52/484, 489, 506.06, 52/506.07, 733.1; D23/133, 134
See application file for complete search history.

7,293,393	B2	11/2007	Kelly et al.	
7,552,567	B2	6/2009	Ingratta et al.	
7,614,195	B2	11/2009	Platt et al.	
D611,332	S *	3/2010	Tedesco et al. D8/380
D617,913	S	6/2010	Shanes et al.	
7,770,349	B2	8/2010	Tedesco et al.	
7,788,872	B2	9/2010	Platt	
D637,899	S	5/2011	Tedesco et al.	
D638,287	S *	5/2011	Tedesco et al. D8/394
D638,288	S	5/2011	Tedesco et al.	
D638,289	S	5/2011	Tedesco et al.	
2009/0165417	A1	7/2009	Jankovec et al.	
2010/0005747	A1 *	1/2010	Tedesco et al. 52/506.08
2011/0146194	A1	6/2011	Tedesco et al.	

* cited by examiner

Primary Examiner — John Windmuller
(74) *Attorney, Agent, or Firm* — Abel Law Group, LLP; Alexander H. Plache

(57) **CLAIM**
The ornamental design for a seismic transition joint clip for suspension ceiling system, as shown and described.

(56) **References Cited**

U.S. PATENT DOCUMENTS

1,675,654	A *	7/1928	Mahar	190/37
D248,013	S *	5/1978	Win	D8/373
4,479,341	A	10/1984	Schuplin		
D309,027	S	7/1990	Noone et al.		
D312,783	S *	12/1990	Sharp	D9/434
5,046,294	A	9/1991	Platt		
5,941,029	A *	8/1999	MacLeod	52/167.1

DESCRIPTION

FIG. 1 is an isometric view of a seismic transition joint clip for suspension ceiling system showing my new design. FIGS. 2 and 3 are front and back views of the clip of FIG. 1; FIGS. 4 and 5 are side views of the clip of FIG. 1; and, FIGS. 6 and 7 are top and bottom views of the clip of FIG. 1.

1 Claim, 5 Drawing Sheets

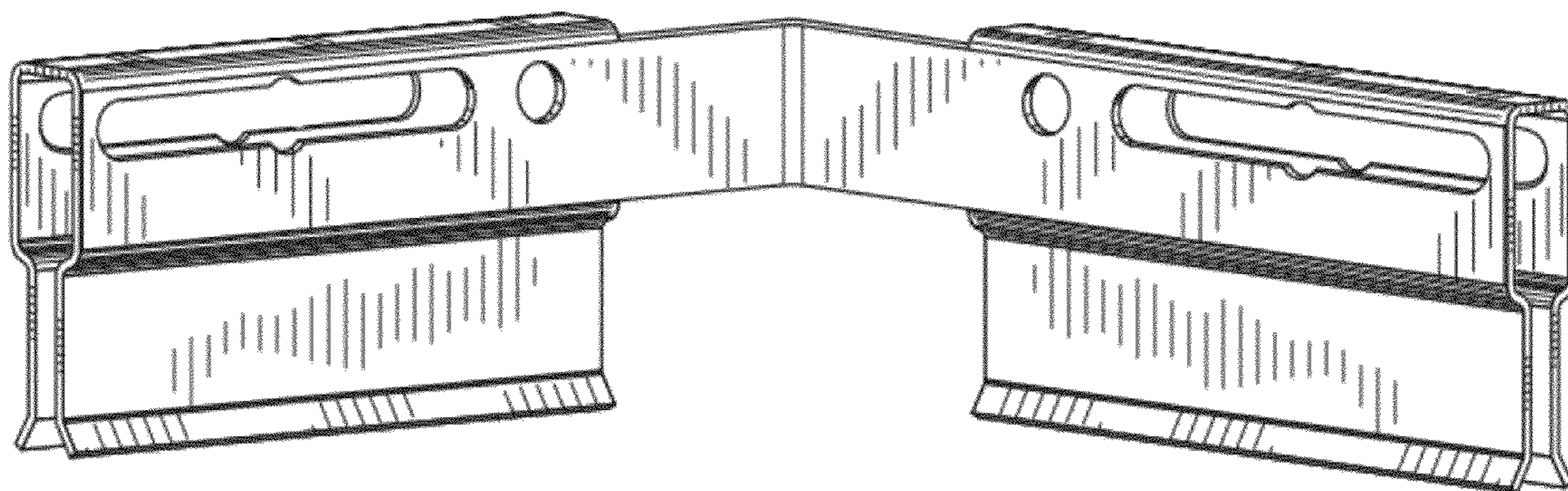

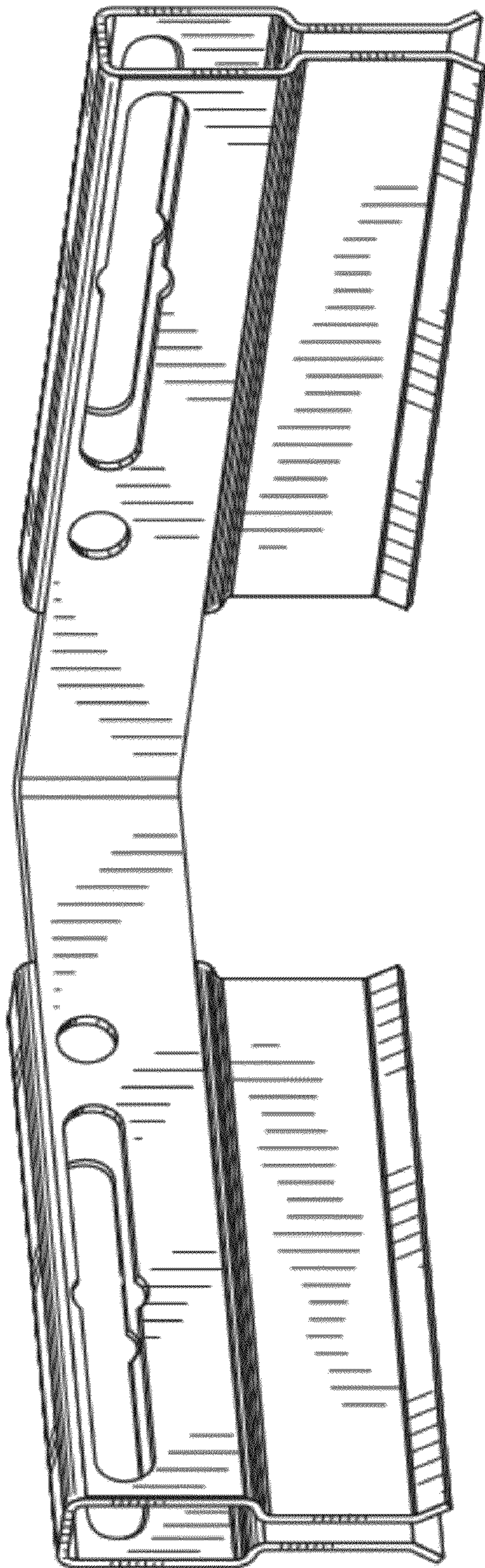

FIG. 1

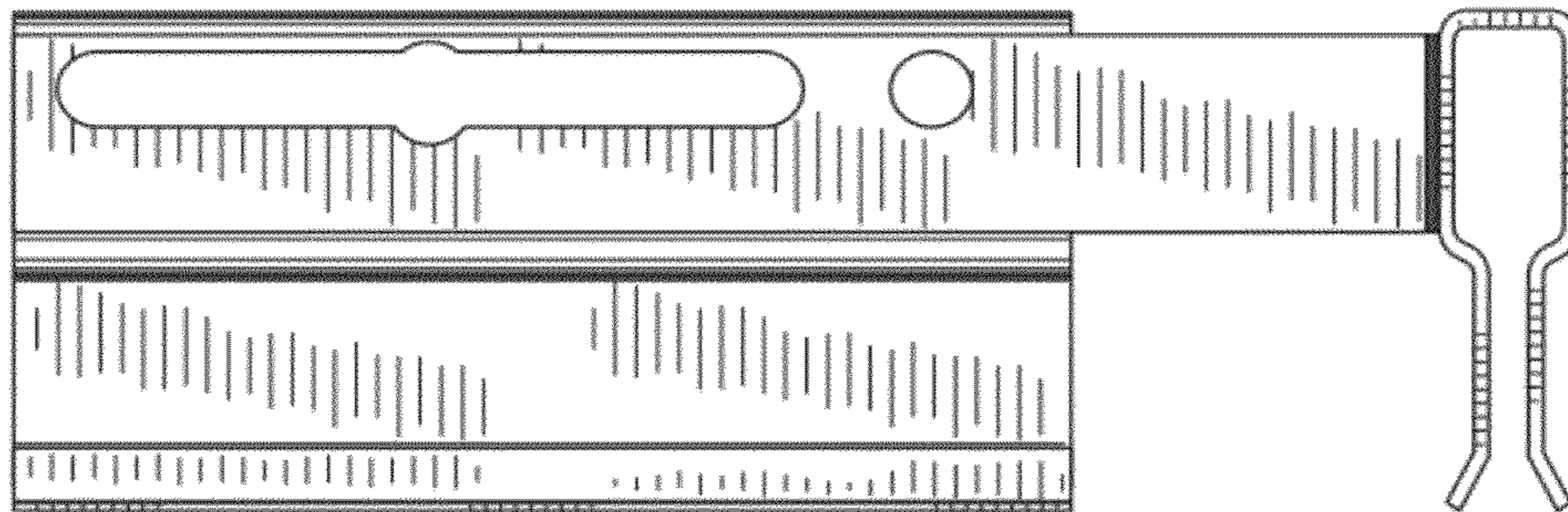

FIG. 2

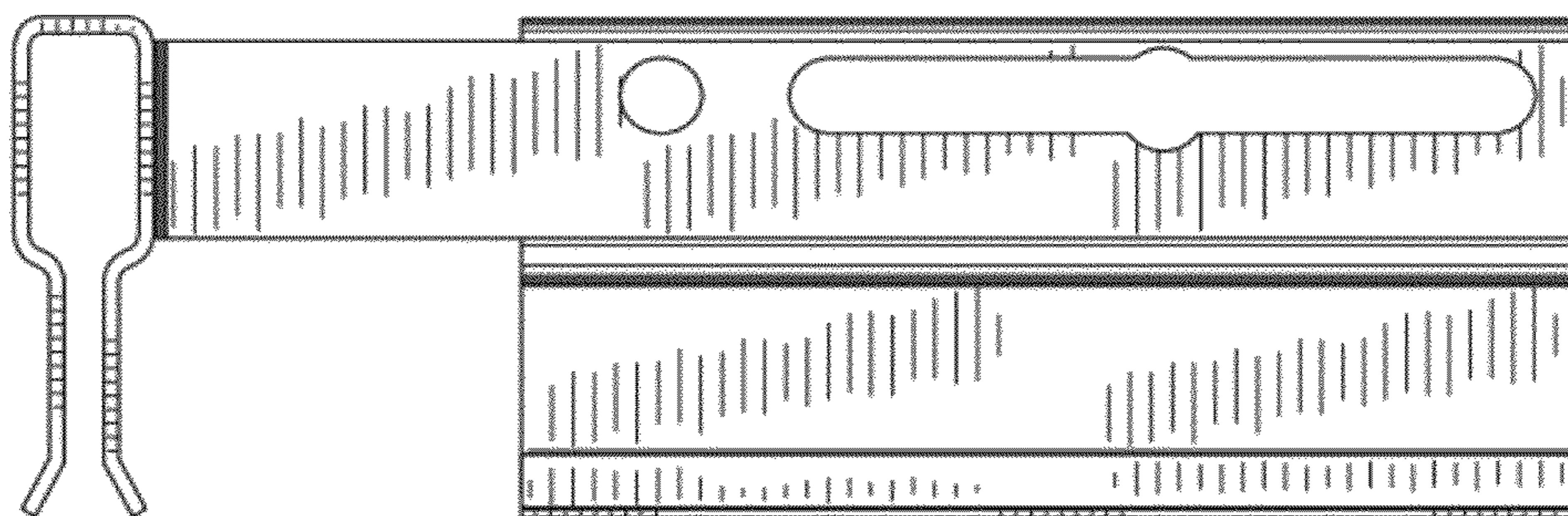

FIG. 3

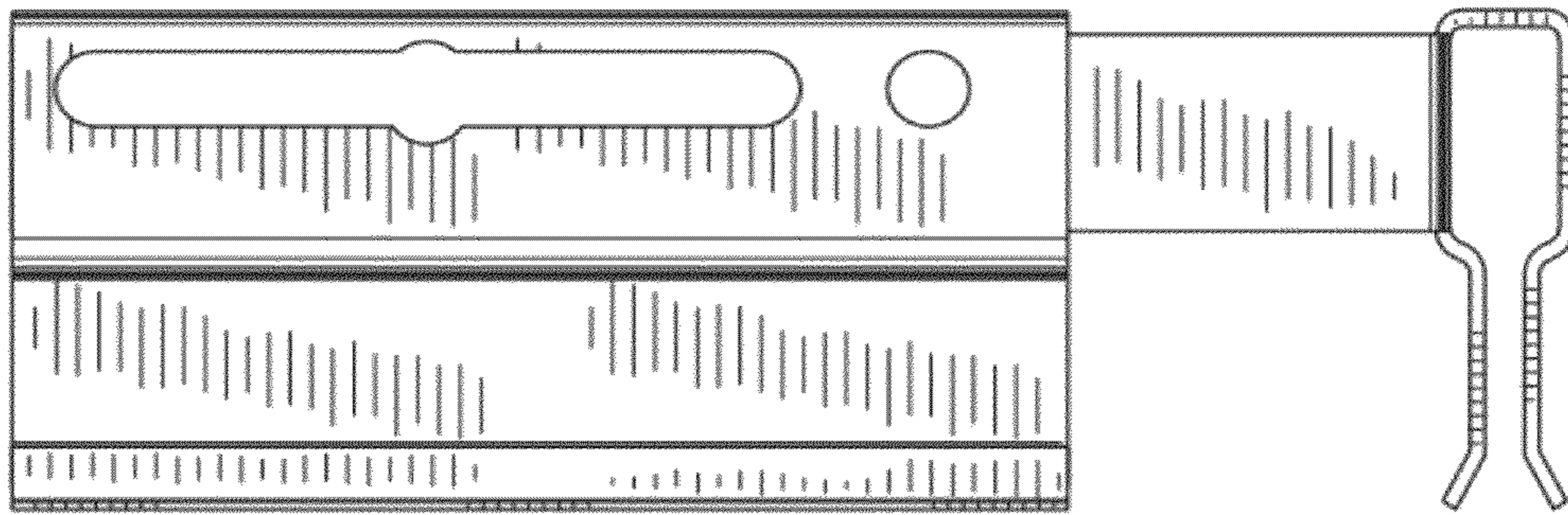

FIG. 4

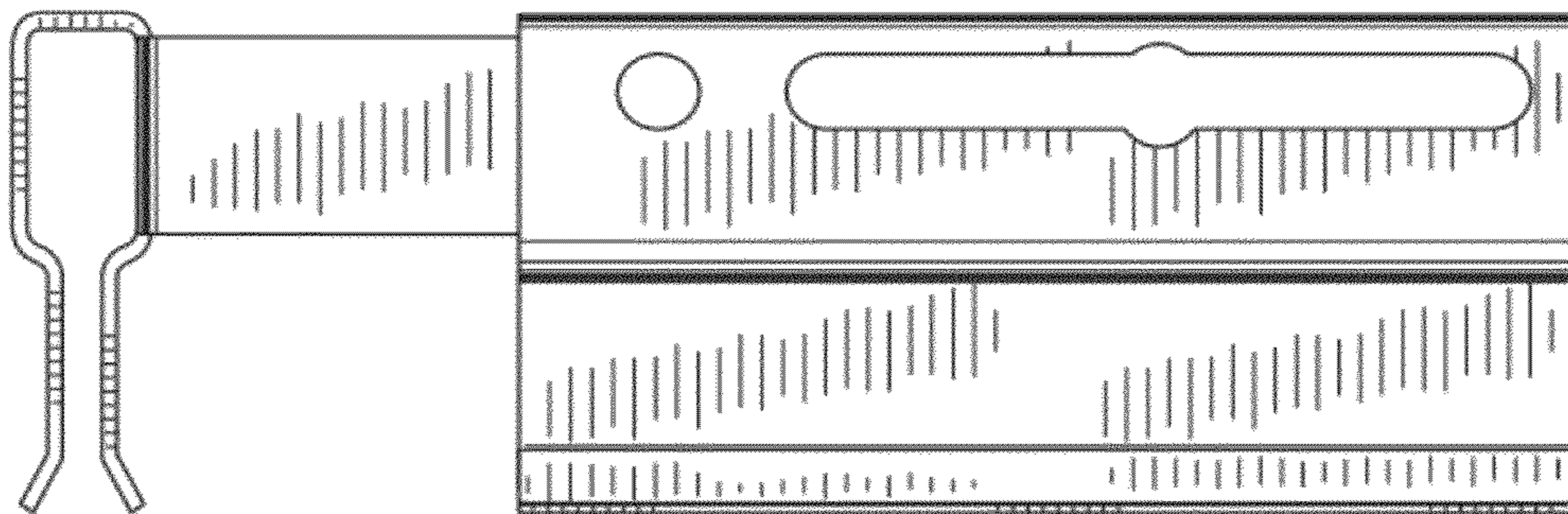

FIG. 5

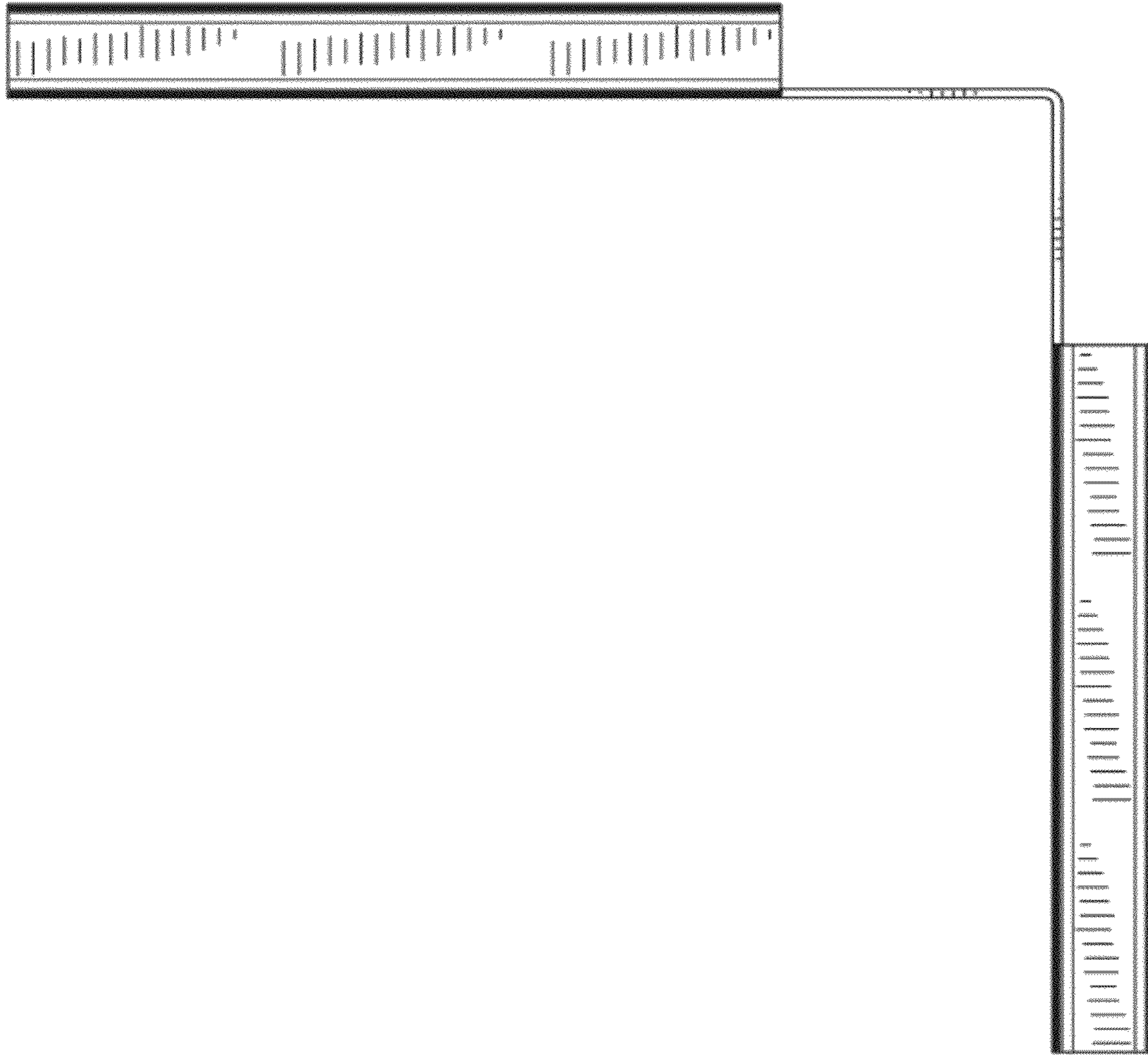

FIG. 6

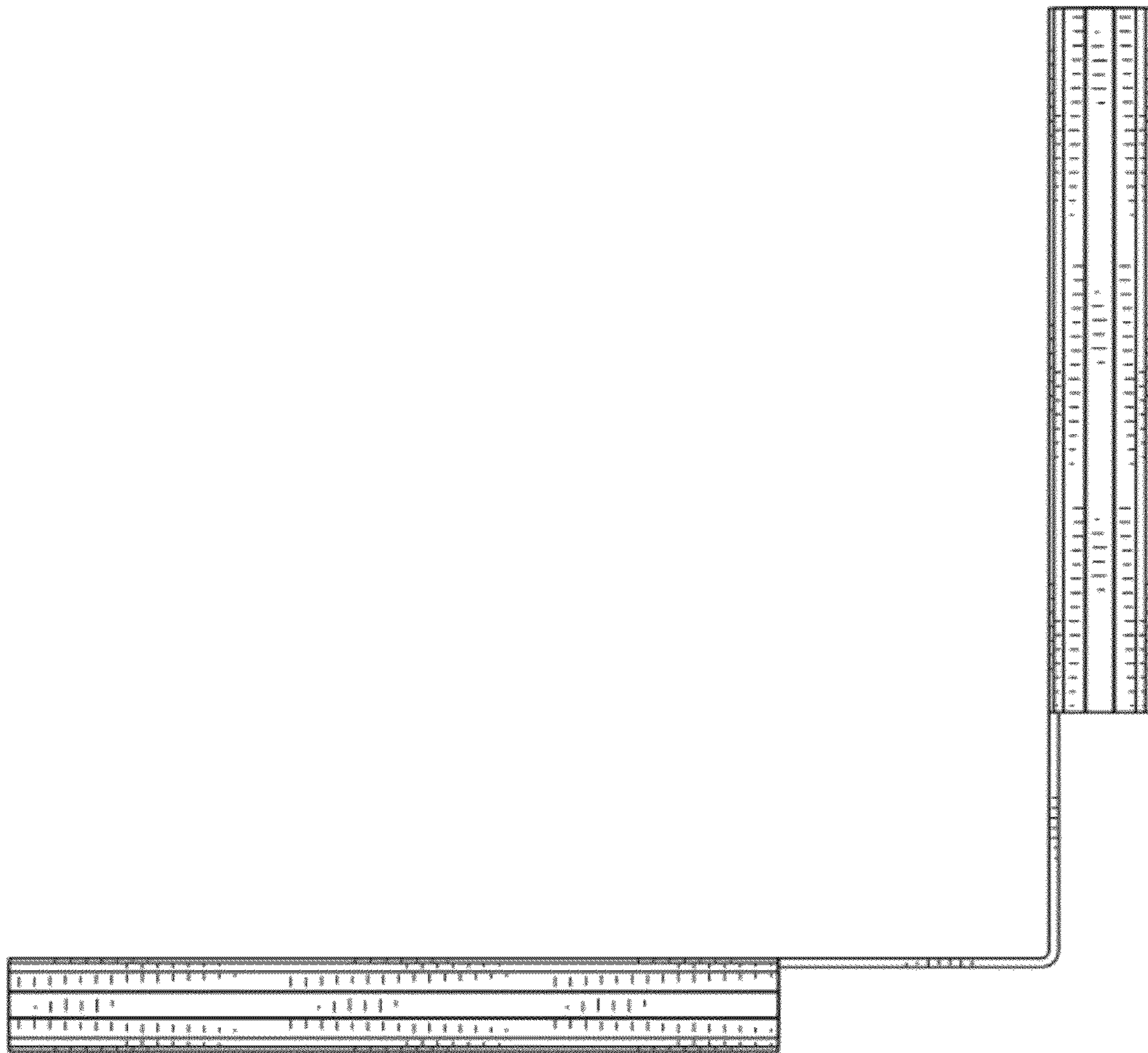

FIG. 7