



US00D662399S

(12) **United States Design Patent**
Kope

(10) **Patent No.:** **US D662,399 S**
(45) **Date of Patent:** **** Jun. 26, 2012**

- (54) **LOCKING SWIVEL HOOK**
- (75) Inventor: **Tyler R. M. Kope**, Seattle, WA (US)
- (73) Assignee: **Black Rapid, Inc.**, Seattle, WA (US)
- (**) Term: **14 Years**
- (21) Appl. No.: **29/403,219**
- (22) Filed: **Oct. 3, 2011**

Related U.S. Application Data

- (62) Division of application No. 29/361,125, filed on May 5, 2010, now Pat. No. Des. 649,018.
- (51) **LOC (9) Cl.** **08-05**
- (52) **U.S. Cl.** **D8/367; D8/356**
- (58) **Field of Classification Search** D8/367, D8/323, 382, 356, 354, 372, 1; D12/115, D12/317; D3/328, 207; 63/8, 7, 12, 15, 63/1.14; D6/323; 248/301-304, 175, 63; 70/59; 402/35; 114/218, 114; 24/598.1, 24/599.6, 588.1, 592.11, 452, 601.5, 601, 24/599.9, 129 R, 600.9; 294/137, 158, 82.19; 410/101; 182/3; D11/210; D9/752; D19/32
See application file for complete search history.

(56) **References Cited**

U.S. PATENT DOCUMENTS

D337,935 S	8/1993	Hawley	
D355,585 S *	2/1995	Terada et al.	D8/367
5,878,834 A	3/1999	Brainerd et al.	
D434,971 S	12/2000	Cheng	
D435,764 S *	1/2001	Schuster	D8/14
6,550,413 B2	4/2003	Fiorentino et al.	
D491,049 S *	6/2004	Kung	D8/367
D496,251 S	9/2004	Buscart	
D500,244 S *	12/2004	Yoshiguchi	D8/367
D501,643 S *	2/2005	Strand et al.	D10/104.1
D502,389 S *	3/2005	Hong	D8/367

D579,763 S	11/2008	Uehara et al.	
D631,331 S	1/2011	Kelleghan	
D642,449 S *	8/2011	Blaney	D8/356
D649,024 S *	11/2011	Takazakura	D8/367
2006/0179784 A1 *	8/2006	Chen	52/698
2006/0180728 A1 *	8/2006	Abrantes	248/328

FOREIGN PATENT DOCUMENTS

CN	452348	8/2001
CN	D122371	4/2008

* cited by examiner

Primary Examiner — Cynthia Underwood

(74) *Attorney, Agent, or Firm* — Davis Wright Tremaine LLP; George C. Rondeau, Jr.

(57) **CLAIM**

The ornamental design for a locking swivel hook, as shown and described.

DESCRIPTION

FIG. 1 is top left side perspective view of a locking swivel hook showing my new design.
 FIG. 2 is a left side elevational view thereof.
 FIG. 3 is a right side elevational view thereof.
 FIG. 4 is a front elevational view thereof.
 FIG. 5 is a rear elevational view thereof.
 FIG. 6 is a top plan view thereof.
 FIG. 7 is a bottom plan view thereof.
 FIG. 8 is a top left side perspective view of a second embodiment thereof.
 FIG. 9 is a left side elevational view thereof.
 FIG. 10 is a right side elevational view thereof.
 FIG. 11 is a front elevational view thereof.
 FIG. 12 is a rear elevational view thereof.
 FIG. 13 is a top plan view thereof; and,
 FIG. 14 is a bottom plan view thereof.
 The broken lines represent portions of the locking swivel hook that form no part of the claim.

1 Claim, 6 Drawing Sheets

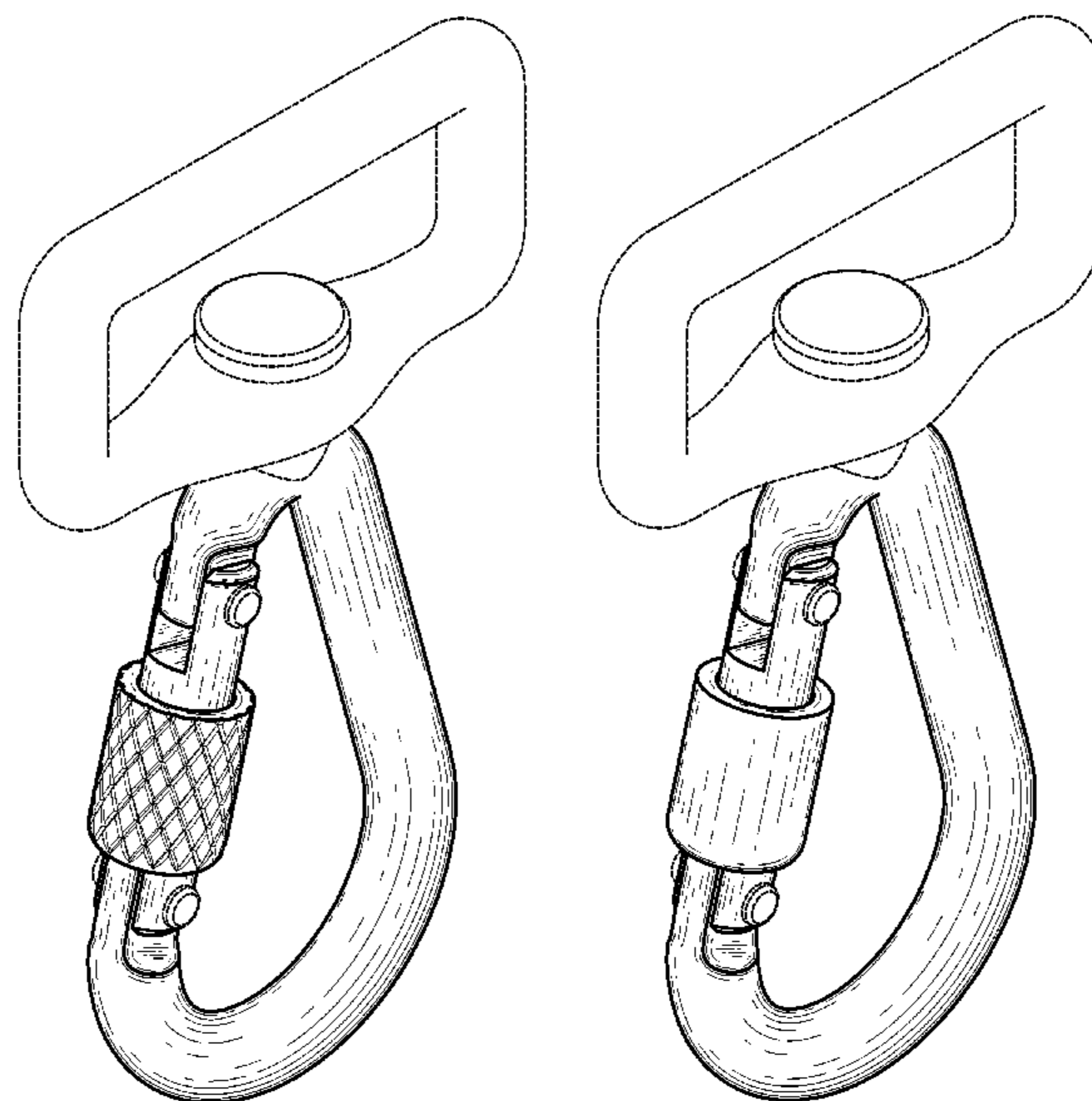

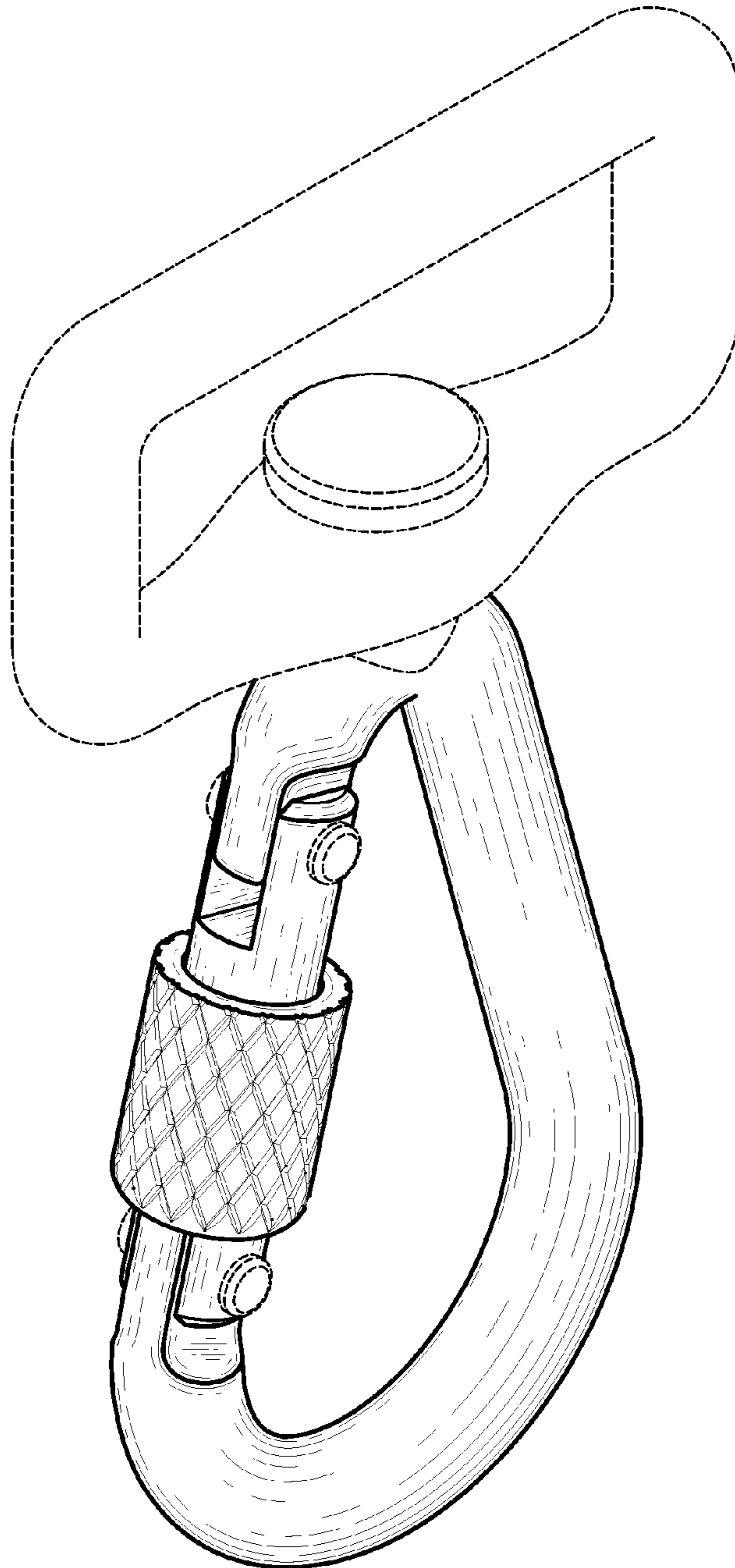

Fig. 1

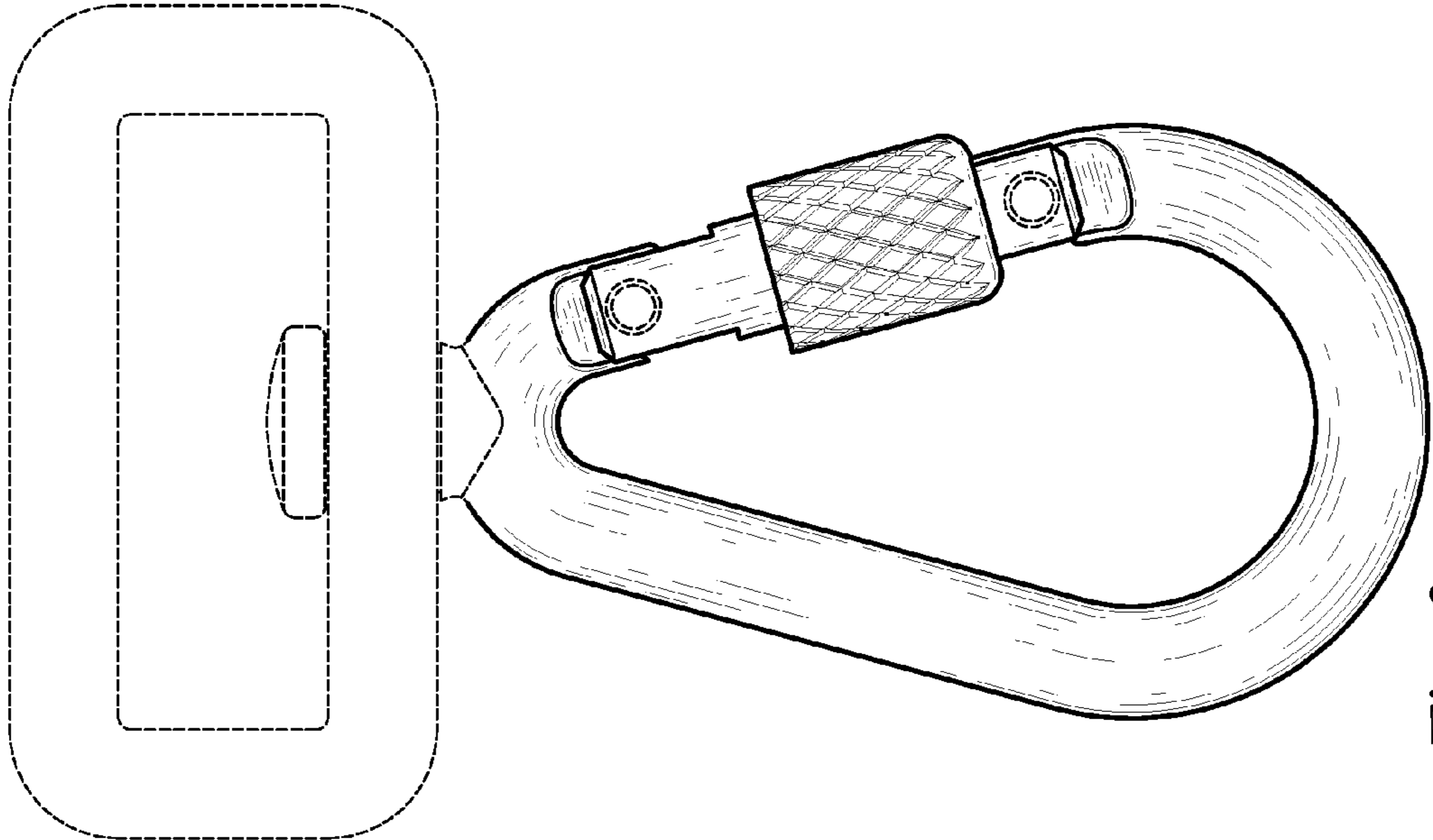

Fig. 3

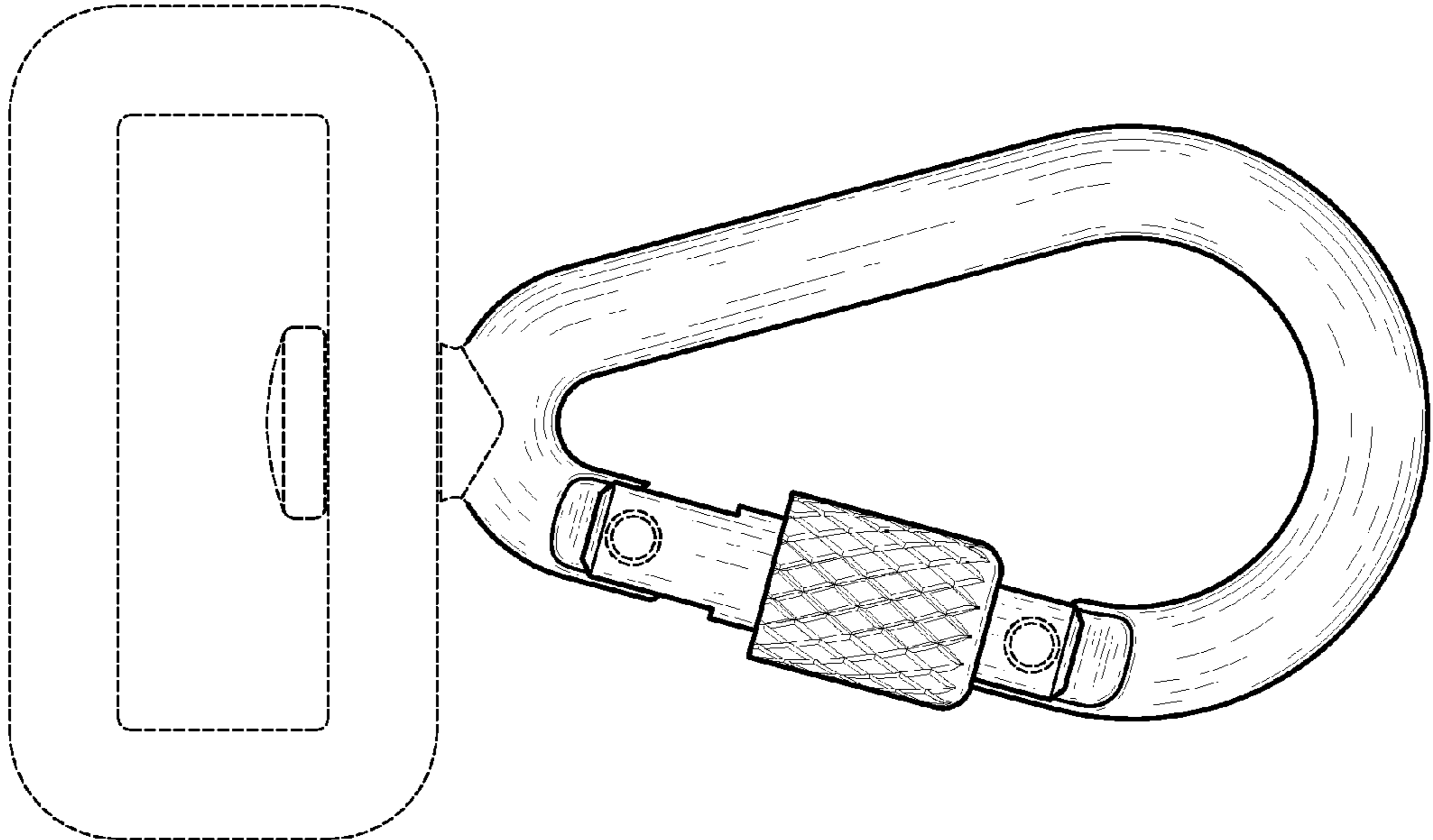

Fig. 2

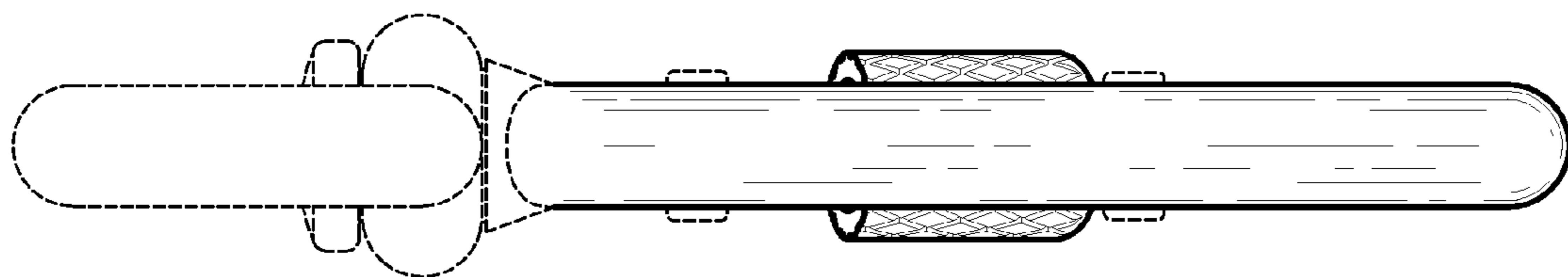

Fig. 4

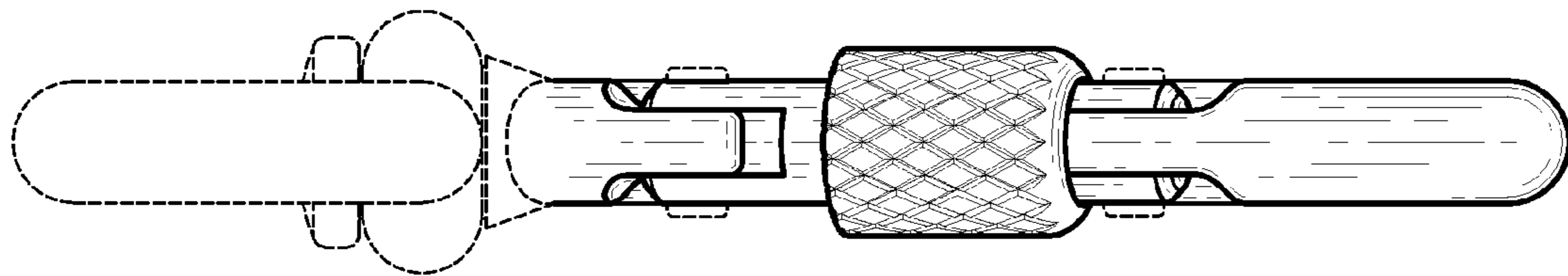

Fig. 5

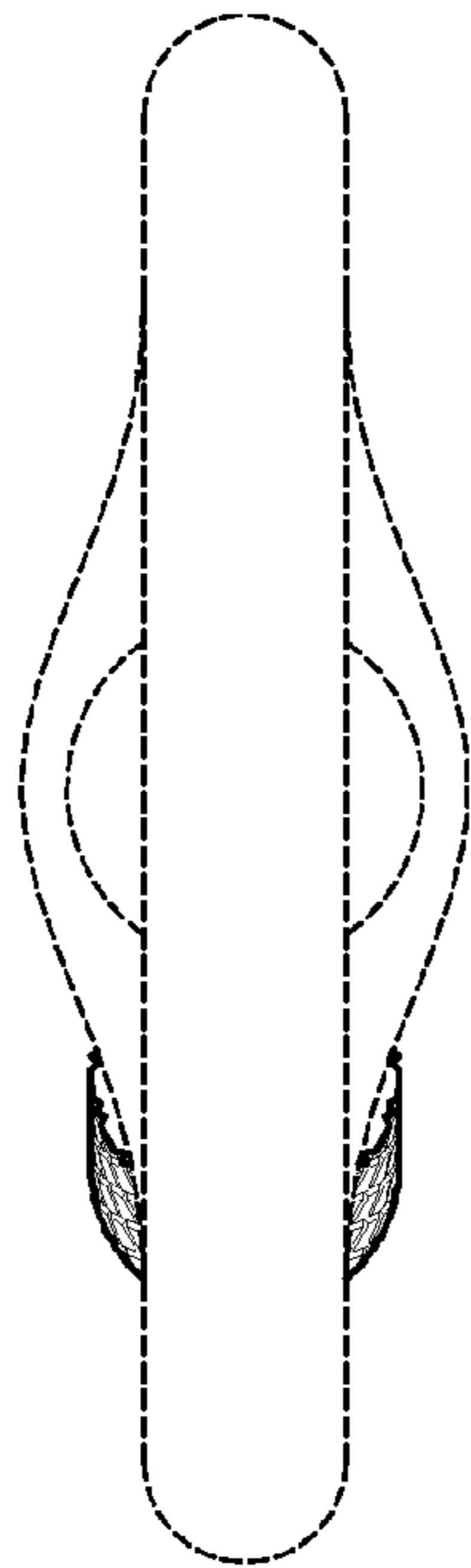

Fig. 6

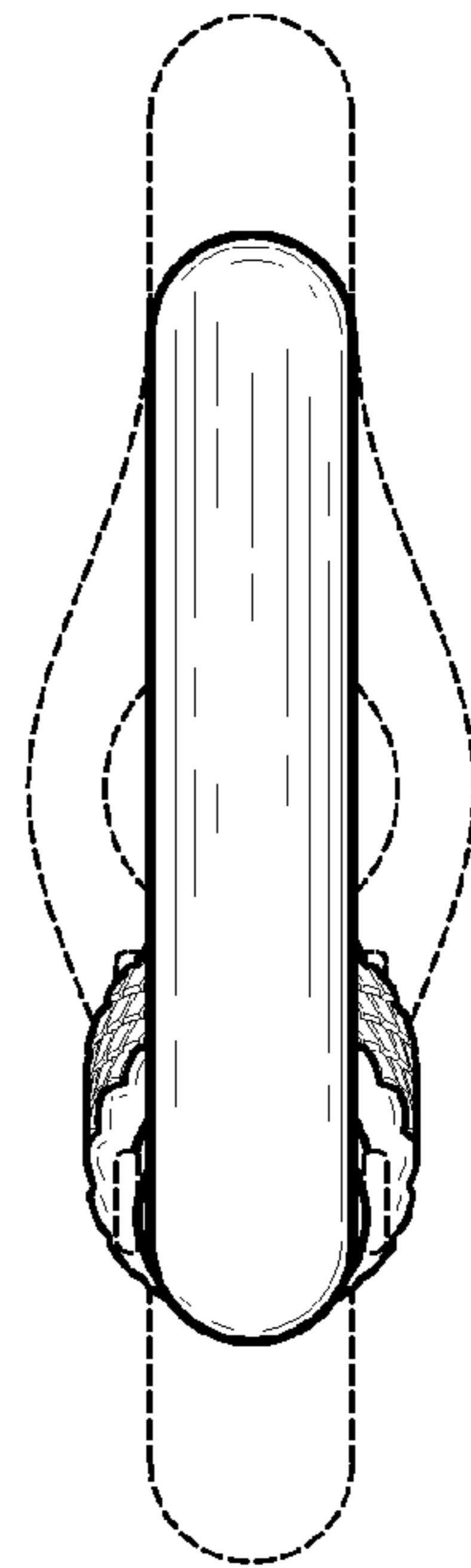

Fig. 7

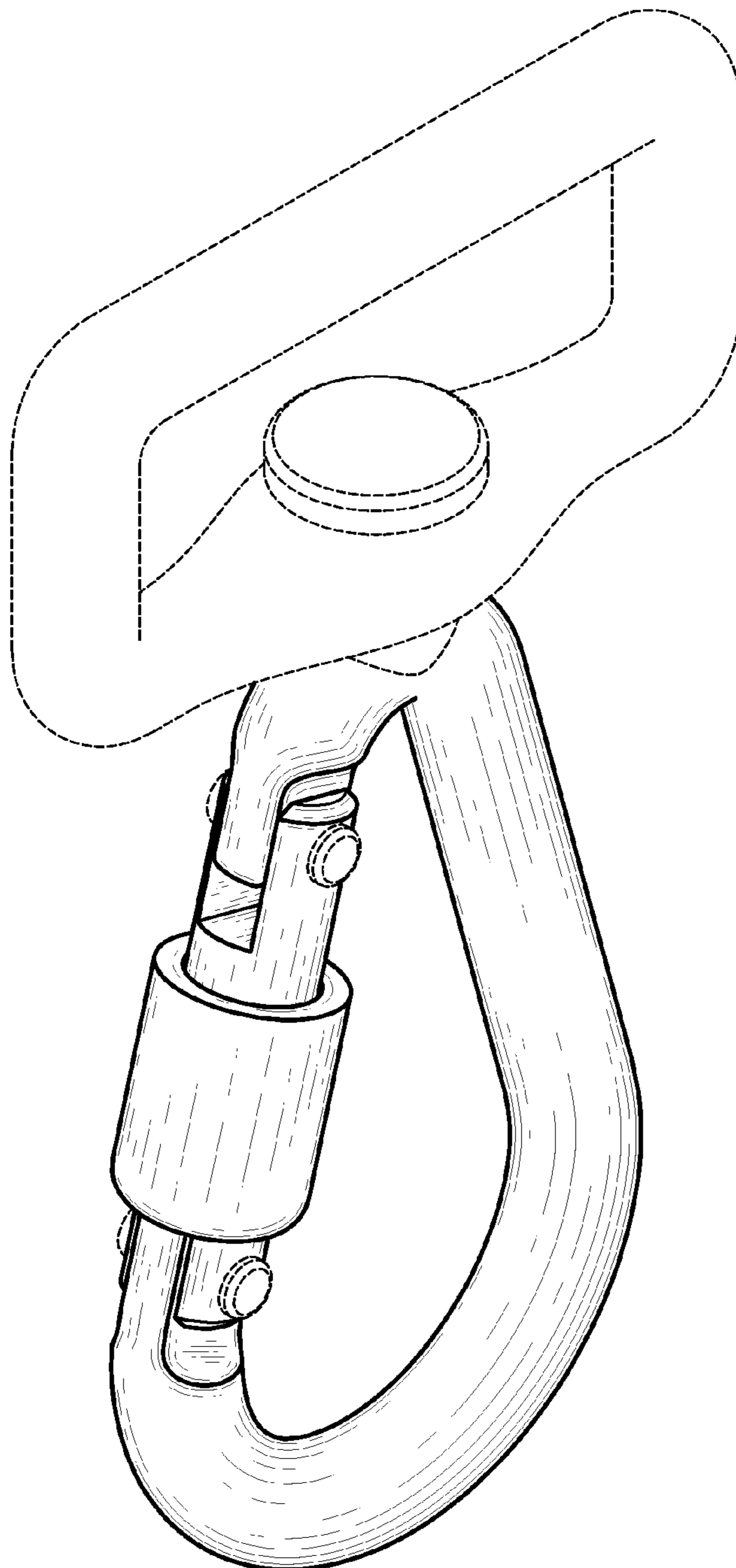

Fig. 8

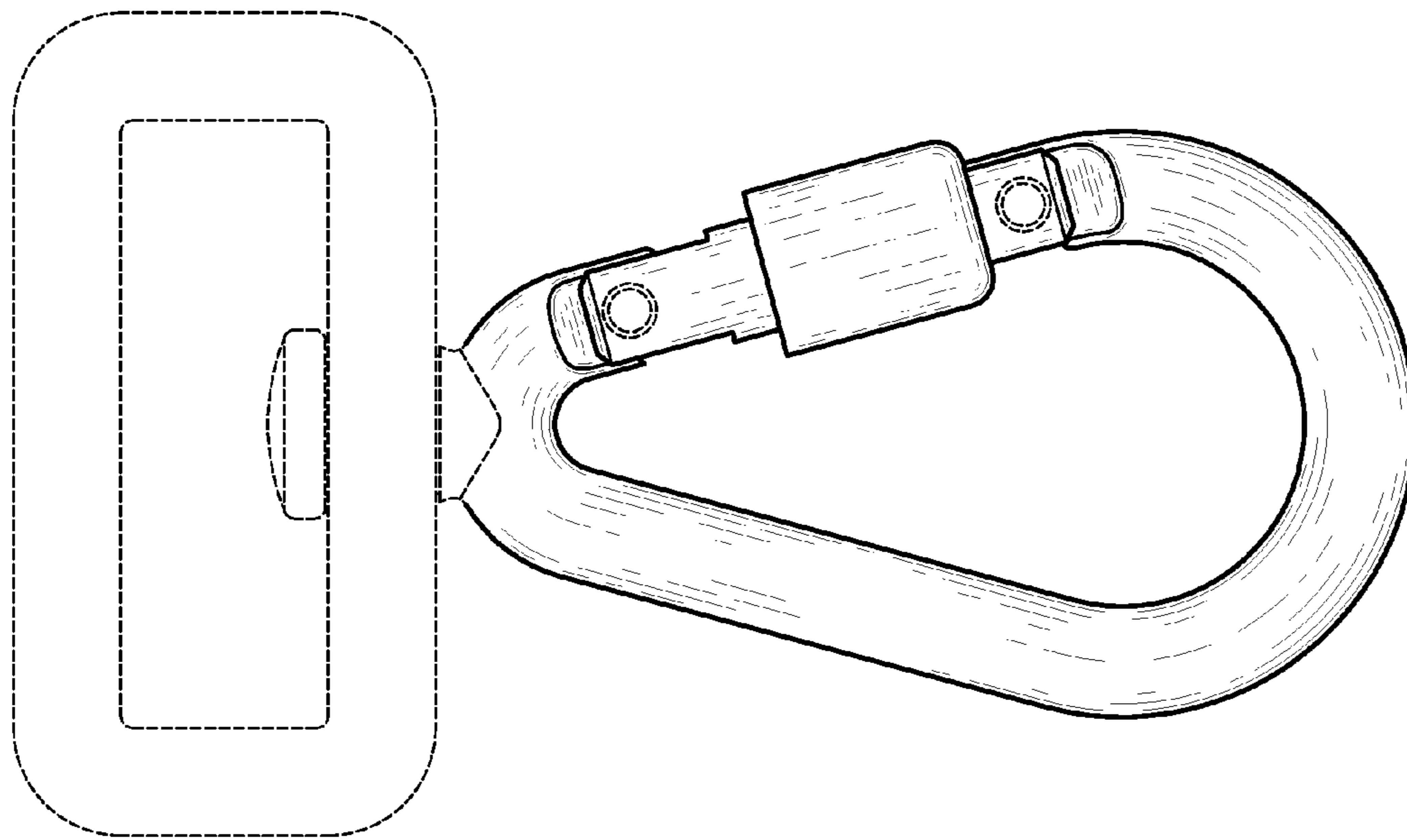

Fig. 9

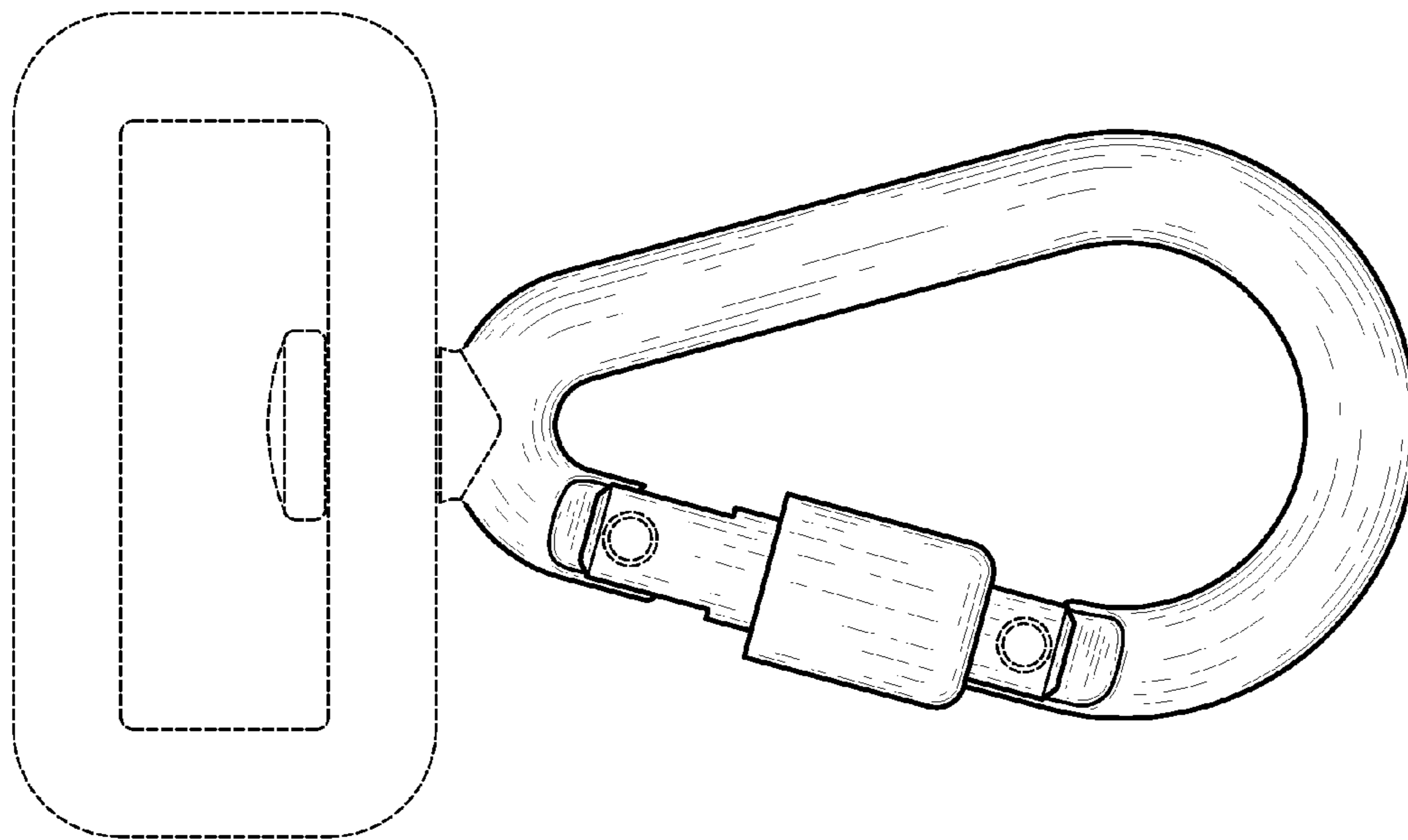

Fig. 10

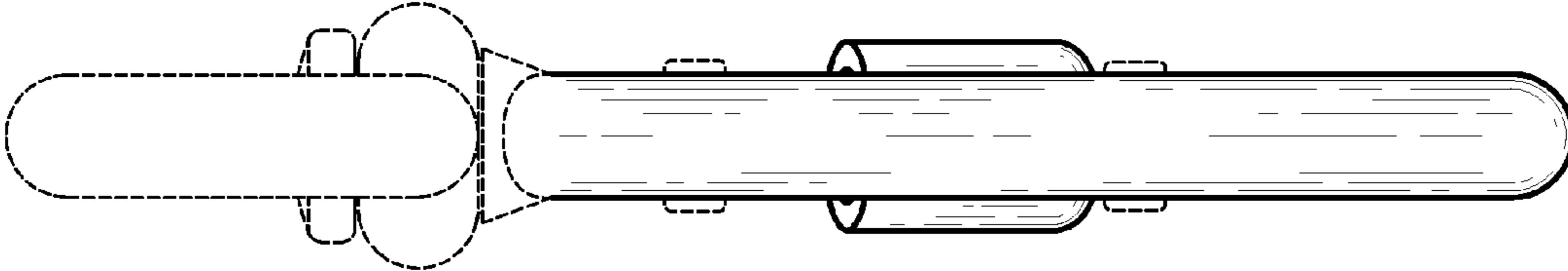

Fig. 11

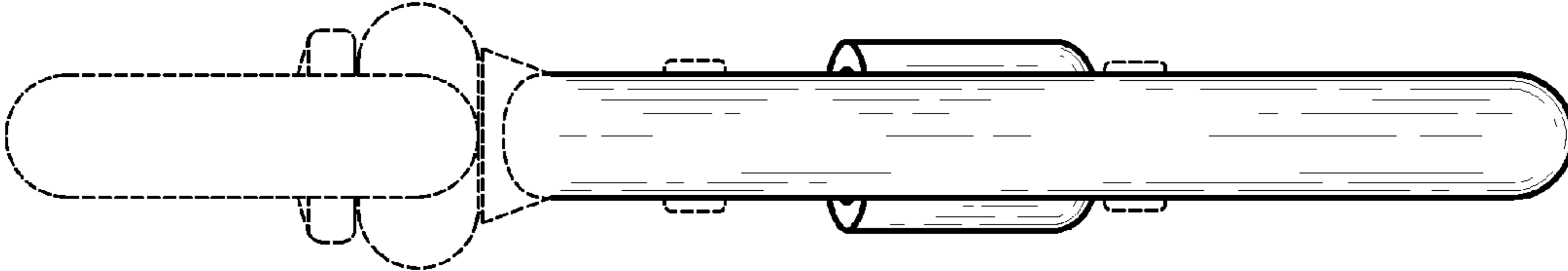

Fig. 12

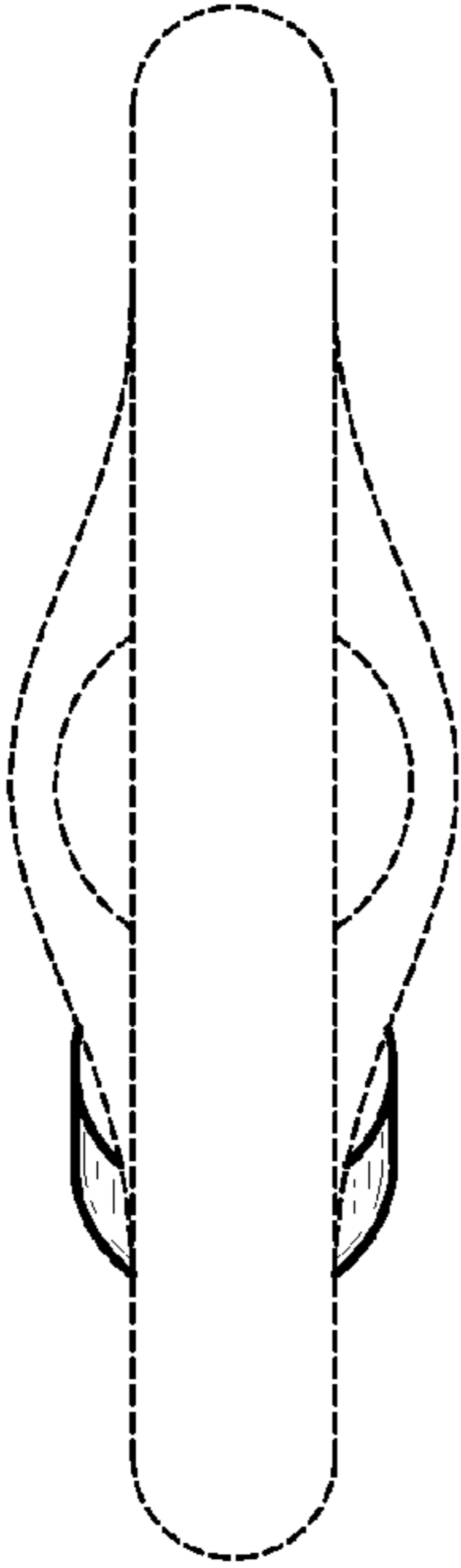

Fig. 13

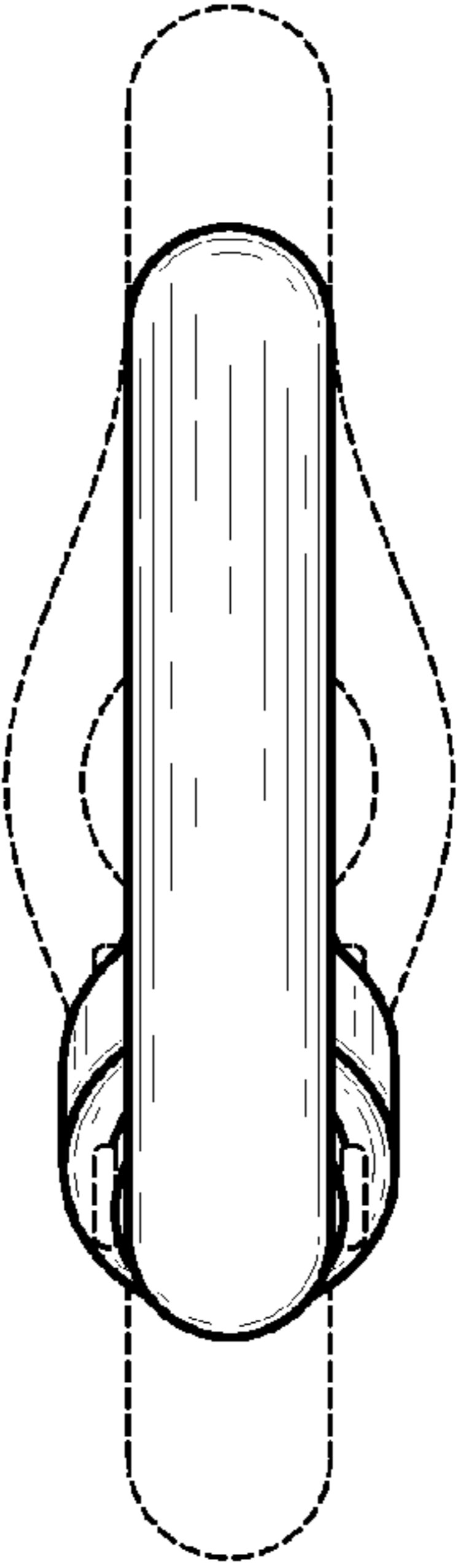

Fig. 14