

US00D662368S

(12) **United States Design Patent**
Zemel

(10) **Patent No.:** **US D662,368 S**

(45) **Date of Patent:** **** Jun. 26, 2012**

(54) **ONION BRUSH**

(75) Inventor: **Marc Zemel**, Old Bethpage, NY (US)

(73) Assignee: **Mr. Bar-B-Q, Inc.**, Old Bethpage, NY (US)

(**) Term: **14 Years**

(21) Appl. No.: **29/388,106**

(22) Filed: **Mar. 24, 2011**

(51) **LOC (9) Cl.** **07-02**

(52) **U.S. Cl.** **D7/669**

(58) **Field of Classification Search** D7/669,
D7/368, 680-696; D4/127, 130-135, 136,
D4/199, 116; 15/186-188, 236.07, 236.08,
15/236.01

See application file for complete search history.

(56) **References Cited**

U.S. PATENT DOCUMENTS

1,191,578	A *	7/1916	Englund	D4/115
D225,889	S *	1/1973	Scholes	D7/669
3,813,721	A *	6/1974	Gaudio	15/29
D245,857	S *	9/1977	Grube	D4/114
4,143,667	A *	3/1979	Peilet	132/116

4,343,265	A *	8/1982	Belschner	15/188
D465,928	S *	11/2002	Solivan	D4/115
D514,328	S *	2/2006	Huang	D4/121
D608,097	S *	1/2010	Zanjani et al.	D4/114

* cited by examiner

Primary Examiner — Terry Wallace

(74) *Attorney, Agent, or Firm* — Kalow & Springut, LLP;
David A. Kalow

(57) **CLAIM**

The ornamental design for an onion brush, as shown and described.

DESCRIPTION

FIG. 1 is a top perspective view of the onion brush.
FIG. 2 is a top side view of the onion brush.
FIG. 3 is a bottom side view of the onion brush.
FIG. 4 is a front side view of the onion brush.
FIG. 5 is a left side view of the onion brush.
FIG. 6 is a right side view of the onion brush.
FIG. 7 is a back side view of the onion brush; and,
FIG. 8 is a close-up top perspective view of the onion brush.
The broken lines are for illustrative purposes only and form no part of the claimed design.

1 Claim, 3 Drawing Sheets

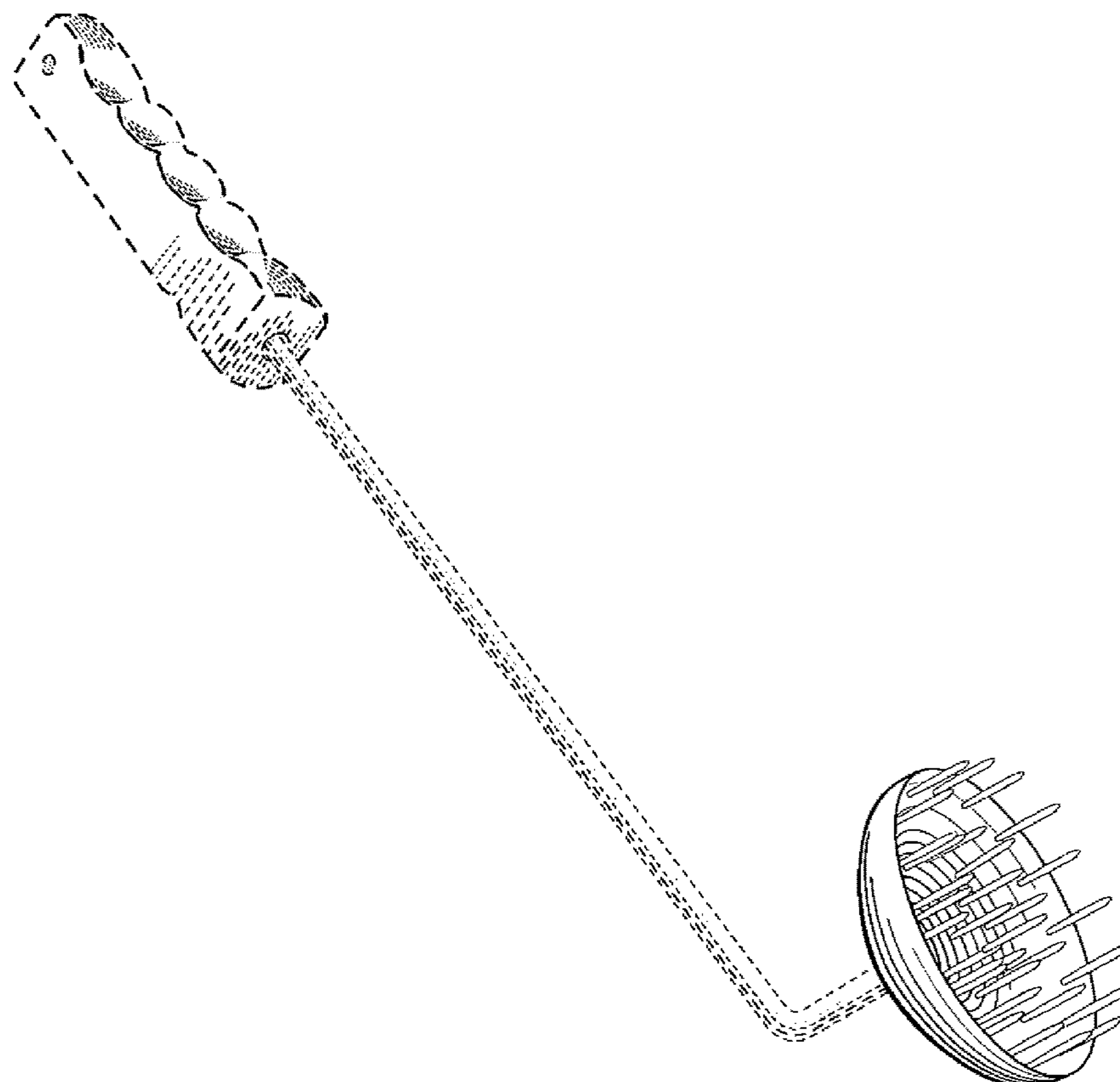

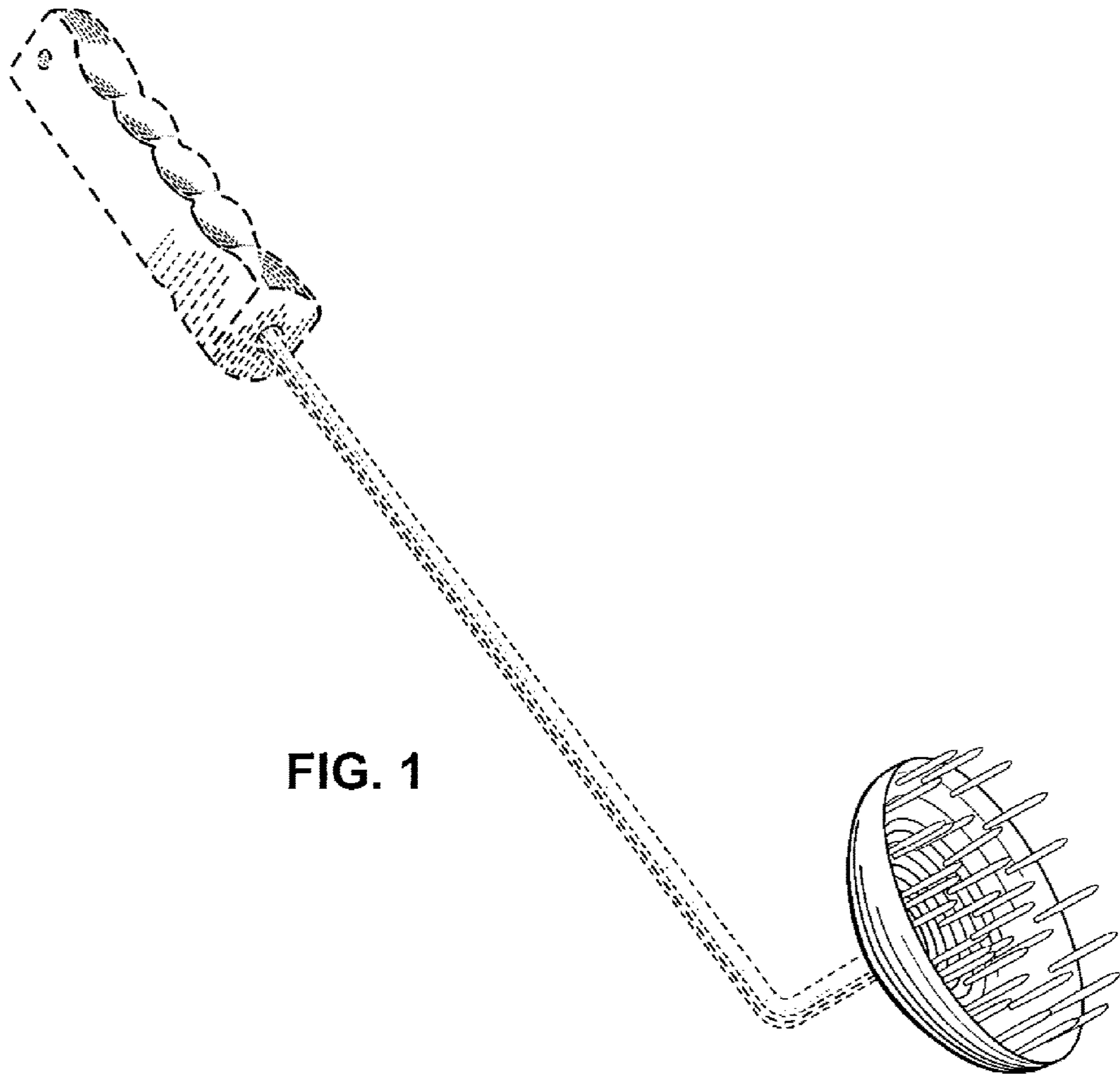

FIG. 1

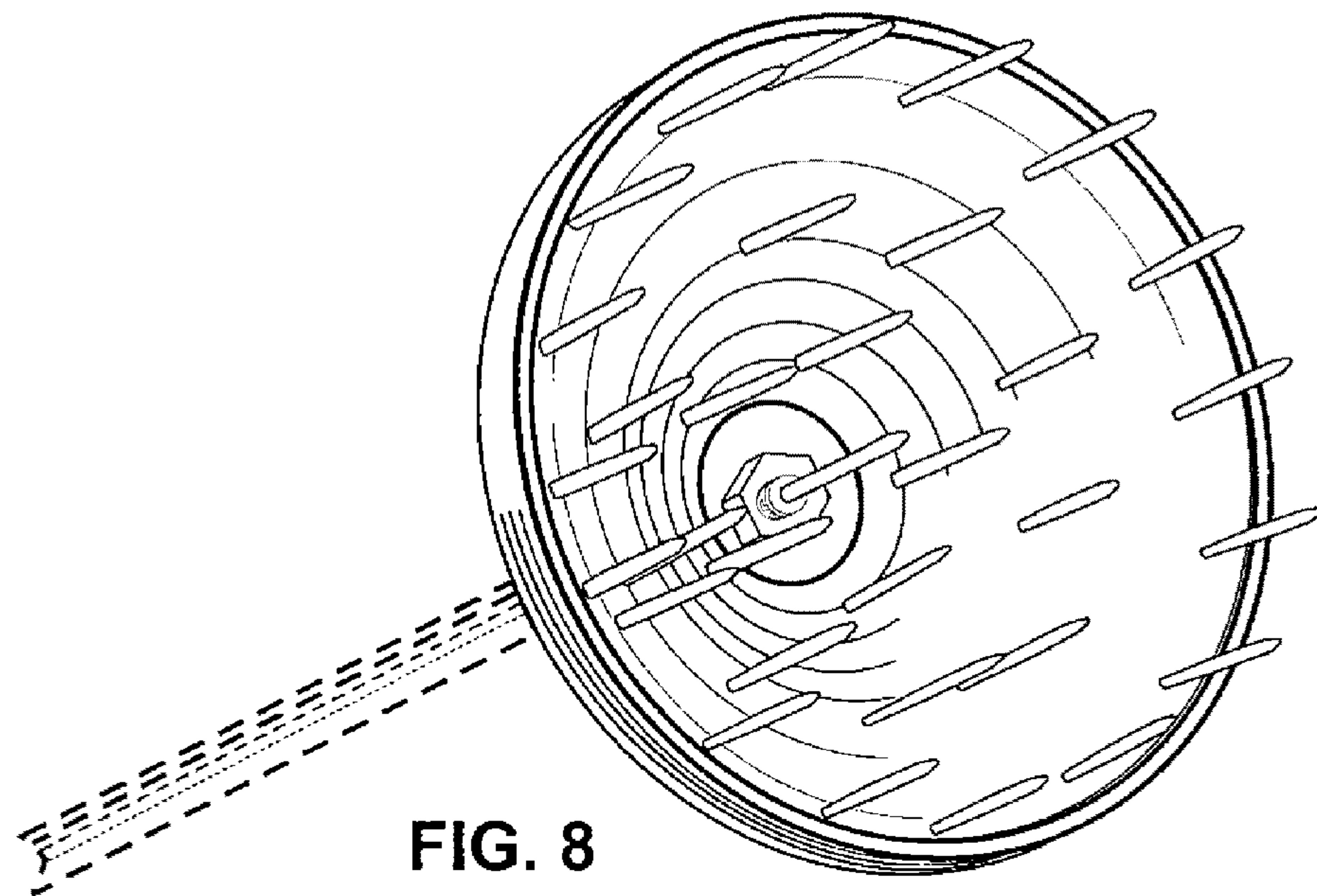

FIG. 8

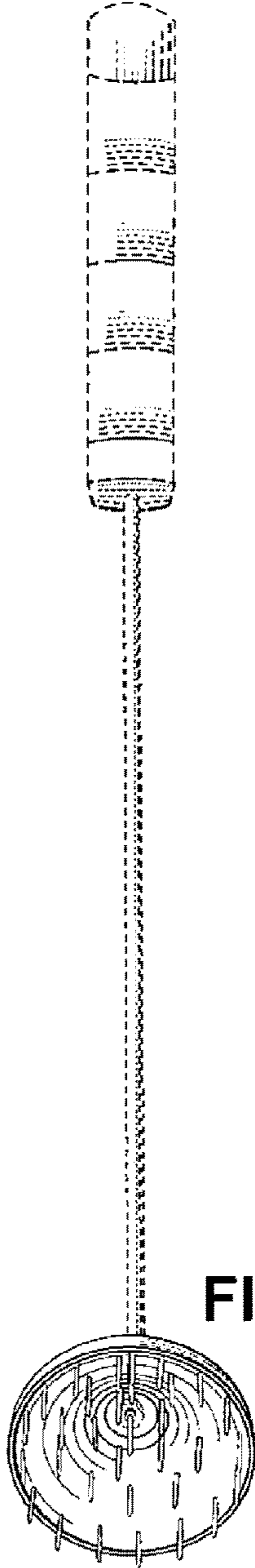

FIG. 2

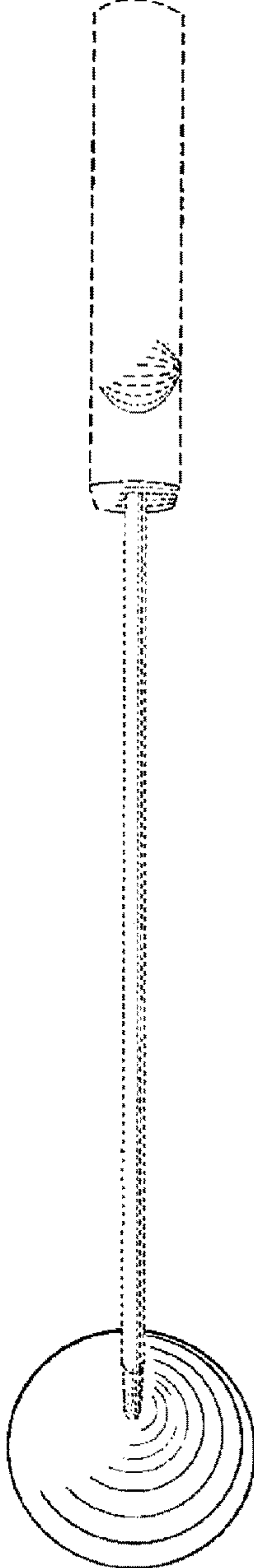

FIG. 3

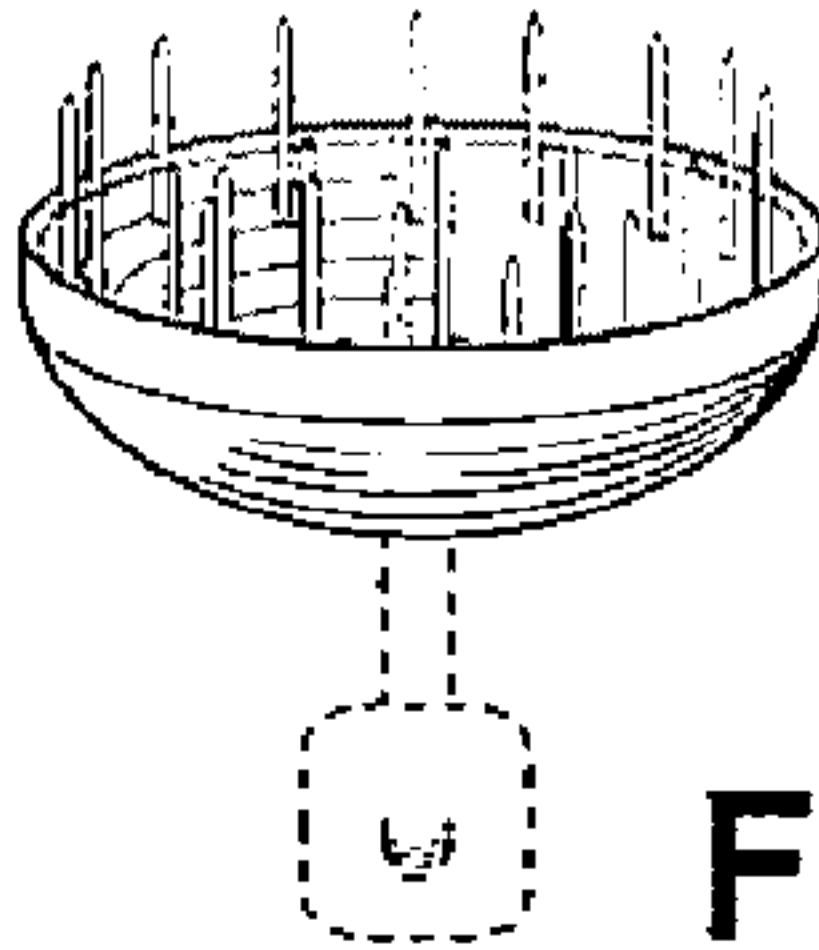

FIG. 4

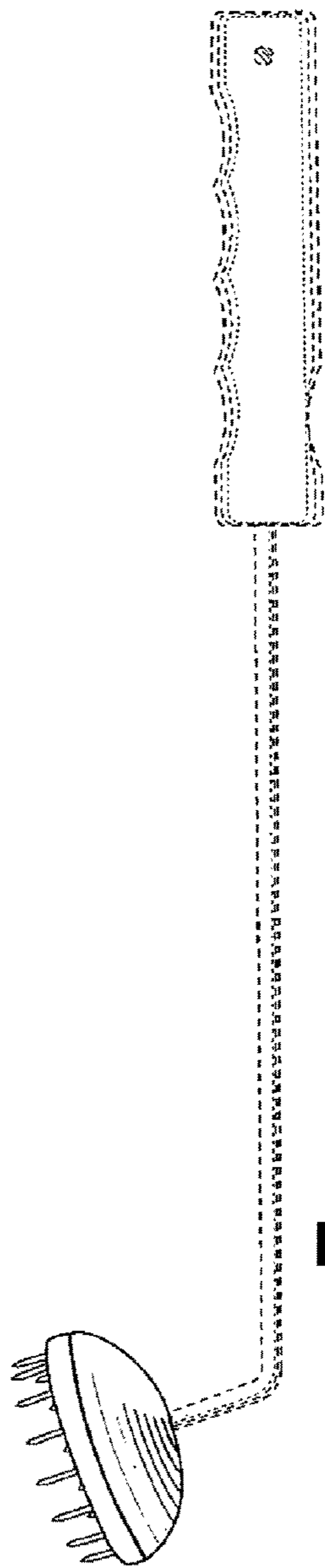

FIG. 5

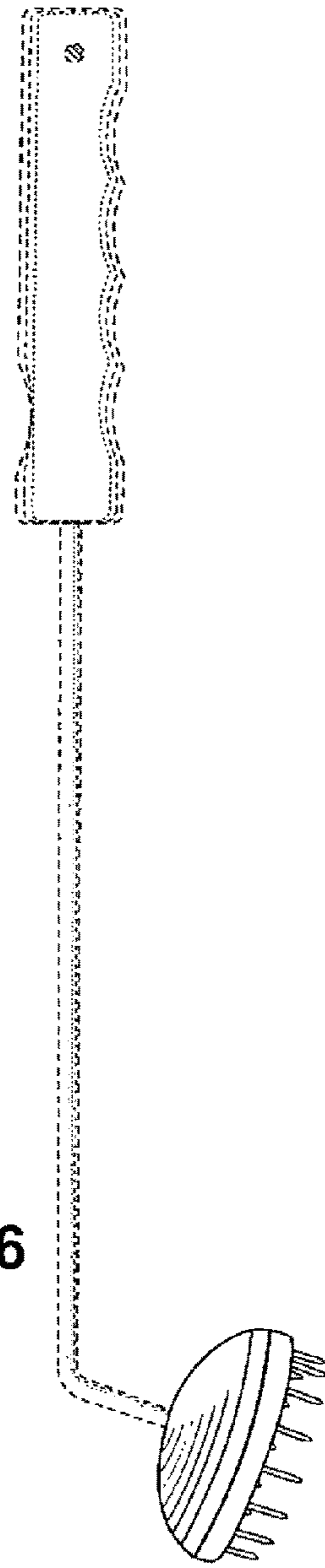

FIG. 6

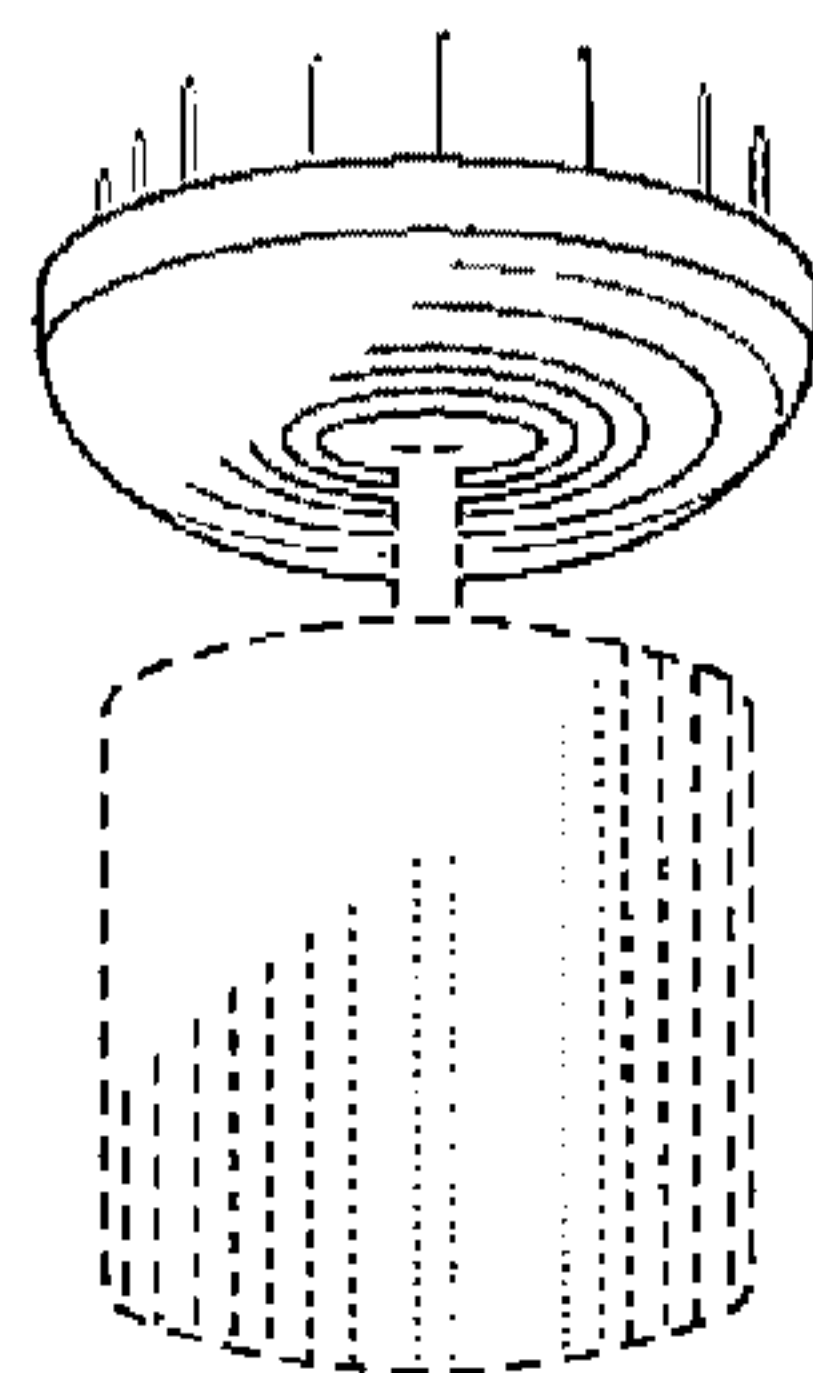

FIG. 7