



US00D662334S

(12) **United States Design Patent**
Schultz

(10) **Patent No.:** **US D662,334 S**
(45) **Date of Patent:** **** Jun. 26, 2012**

(54) **TABLE**

(75) Inventor: **Peter Schultz**, Barto, PA (US)

(73) Assignee: **Richard Schultz Design, Inc.**, Palm, PA (US)

(**) Term: **14 Years**

(21) Appl. No.: **29/373,121**

(22) Filed: **Mar. 2, 2011**

(51) **LOC (9) Cl.** **06-03**

(52) **U.S. Cl.** **D6/484**

(58) **Field of Classification Search** D6/480-489,
D6/495-499, 429, 426; 108/150, 50.01,
108/50.02, 155, 153.1, 156, 157.13, 161,
108/157.14; 248/188, 188.1, 174

See application file for complete search history.

(56) **References Cited**

U.S. PATENT DOCUMENTS

D35,045 S *	9/1901	Stickley	D6/484
D210,735 S *	4/1968	Magistretti	D6/461
D216,711 S *	3/1970	Schultz	D6/484
D426,088 S *	6/2000	Hodge	D6/488
D508,625 S *	8/2005	Frenkler et al.	D6/484
D598,679 S *	8/2009	Domack et al.	D6/488

* cited by examiner

Primary Examiner — Janice Seeger

(74) *Attorney, Agent, or Firm* — Thomas A. O'Rourke;
Bodner & O'Rourke LLP

(57) **CLAIM**

The ornamental design for a table, as shown and described.

DESCRIPTION

FIG. 1 is a perspective view of a table of the present invention;
 FIG. 2 is a front and back view thereof;
 FIG. 3 is a side view thereof;
 FIG. 4 is a top view thereof;
 FIG. 5 is a perspective view of an alternate embodiment of a table of the present invention;
 FIG. 6 is a front and back view thereof;
 FIG. 7 is a side view thereof;
 FIG. 8 is a top view thereof;
 FIG. 9 is a perspective view of a second alternate embodiment of a table of the present invention;
 FIG. 10 is a front and back view thereof;
 FIG. 11 is a side view thereof;
 FIG. 12 is a top view thereof;
 FIG. 13 is a perspective view of a third alternate embodiment of a table of the present invention;
 FIG. 14 is a front and back view thereof;
 FIG. 15 is a side view thereof; and,
 FIG. 16 is a top view thereof.

1 Claim, 16 Drawing Sheets

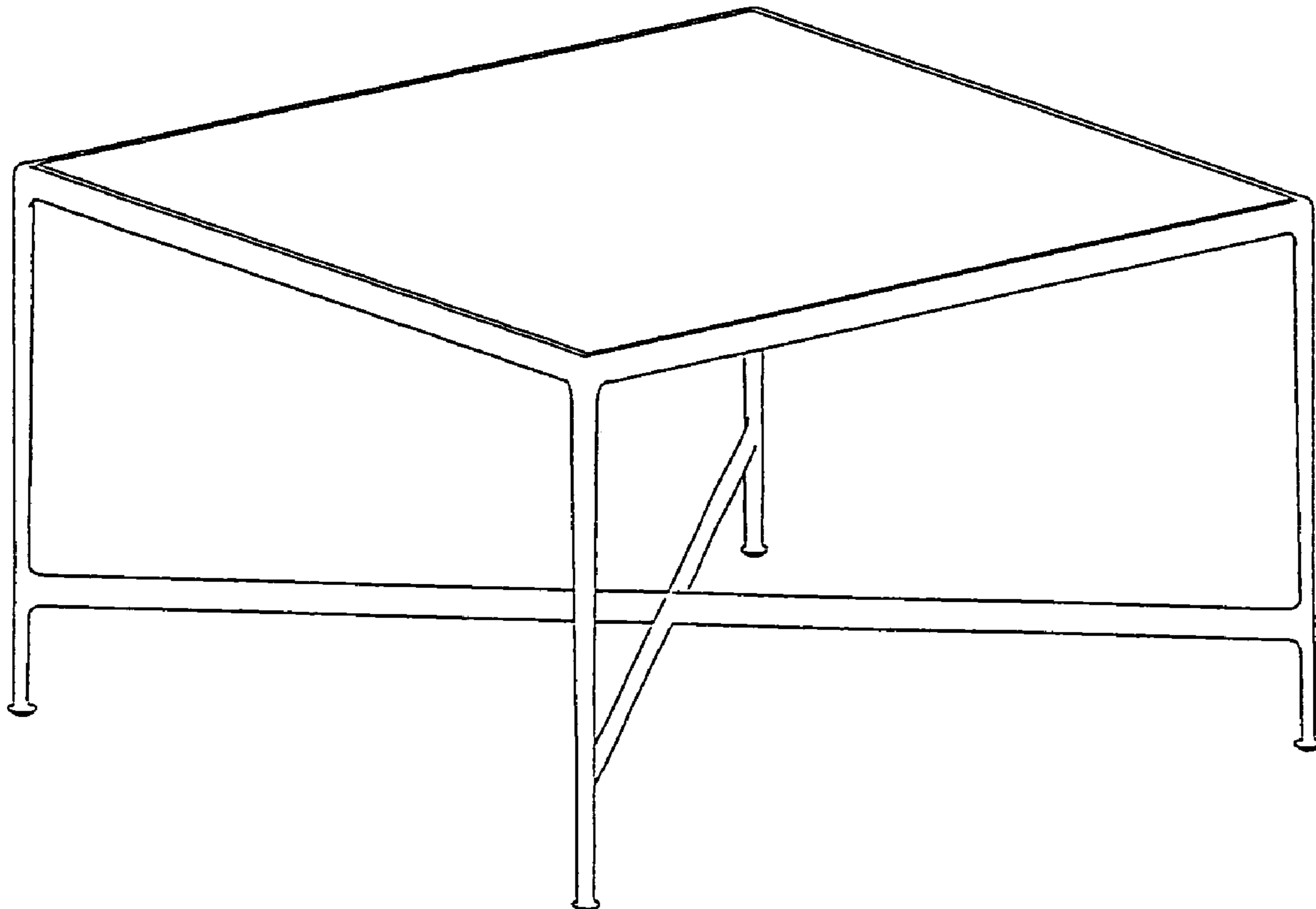

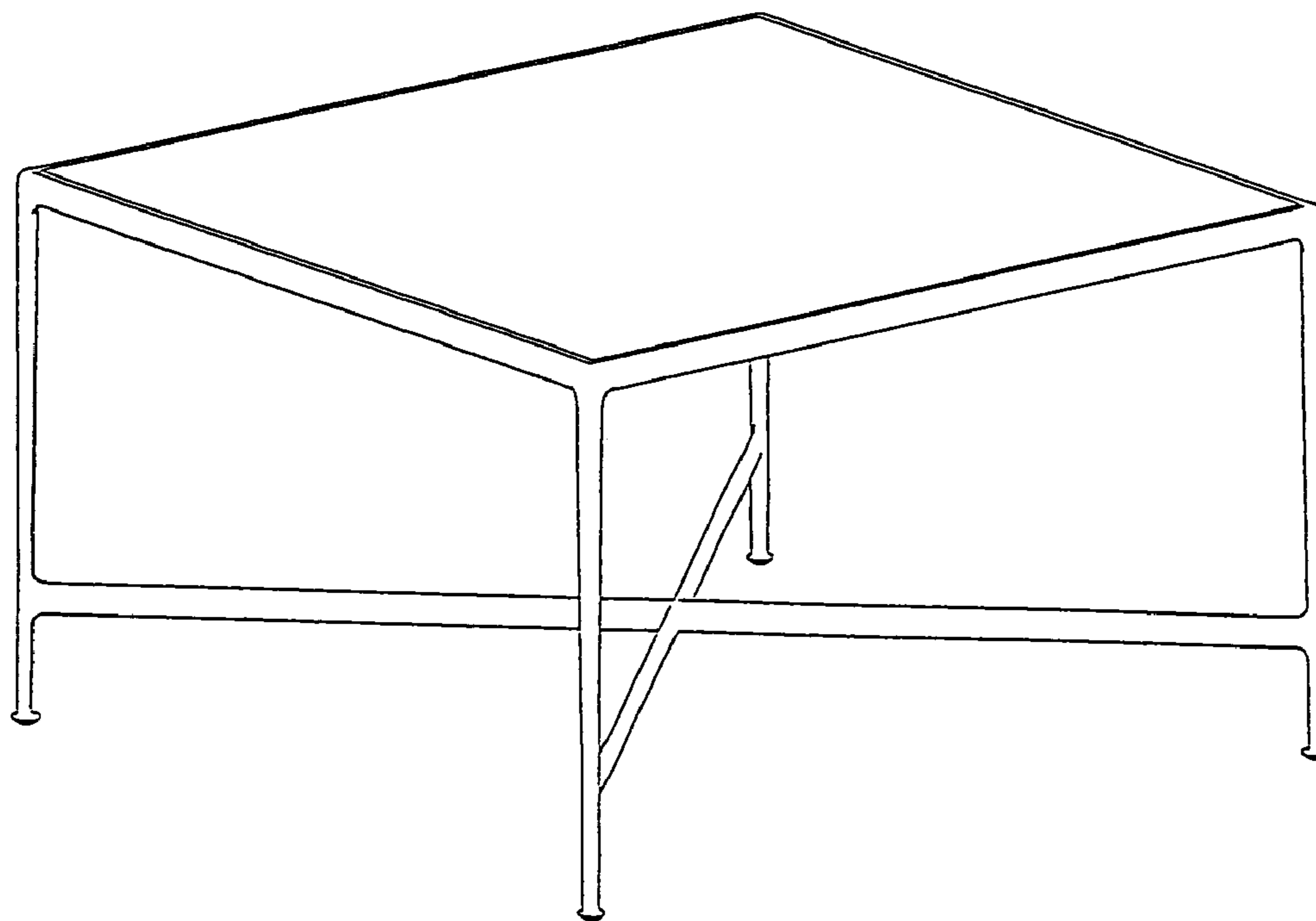

Fig. 1

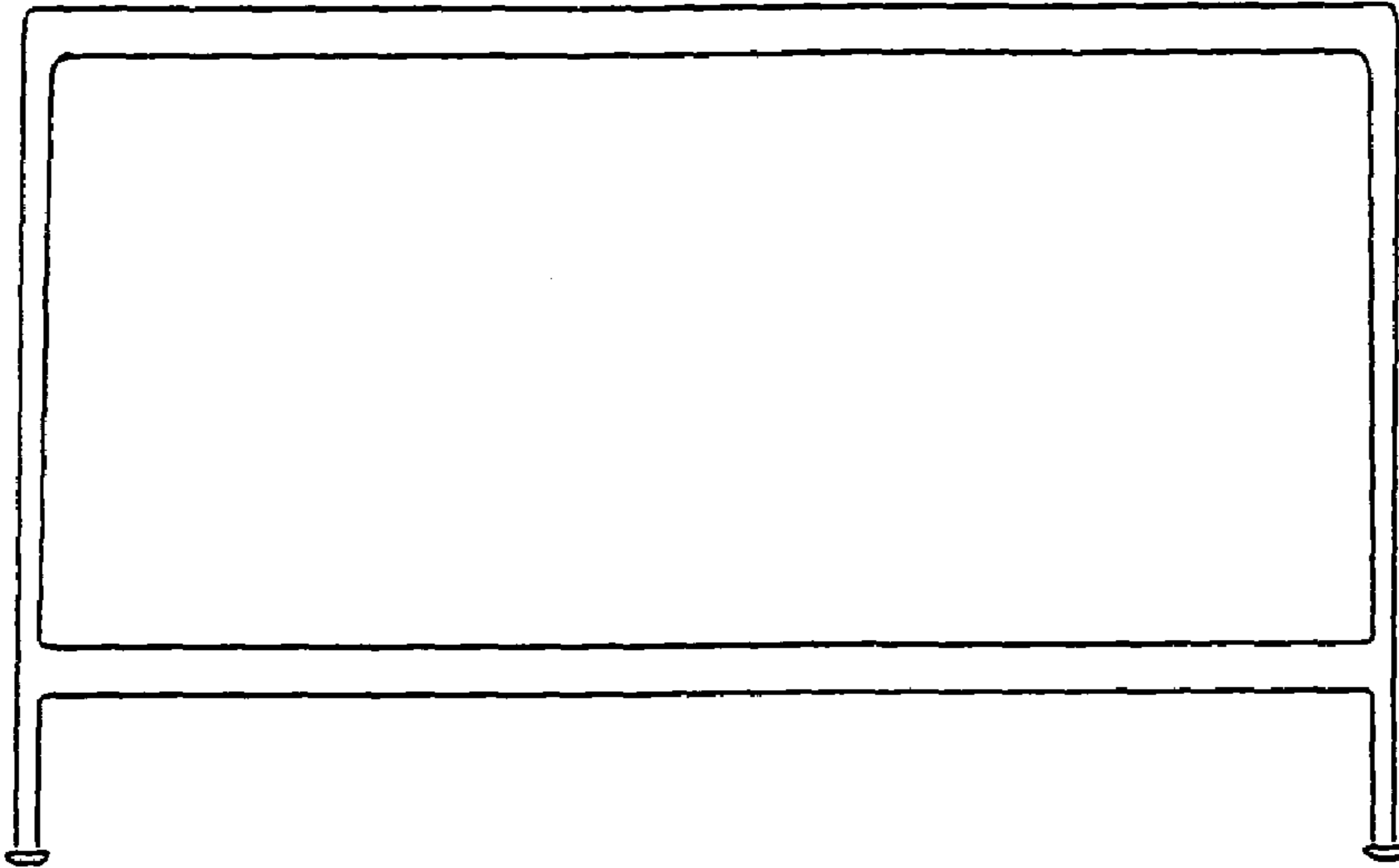

Fig. 2

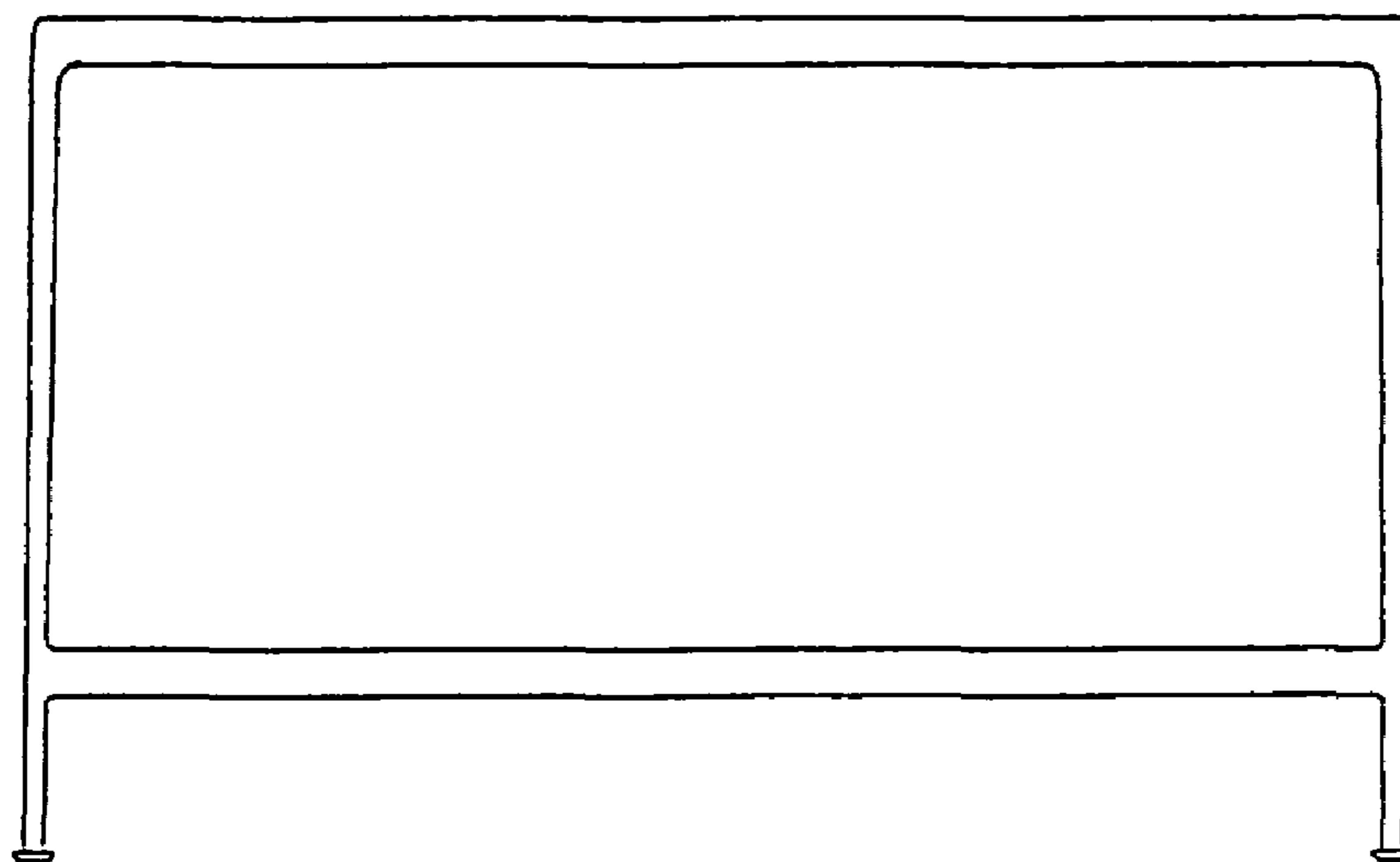

Fig. 3

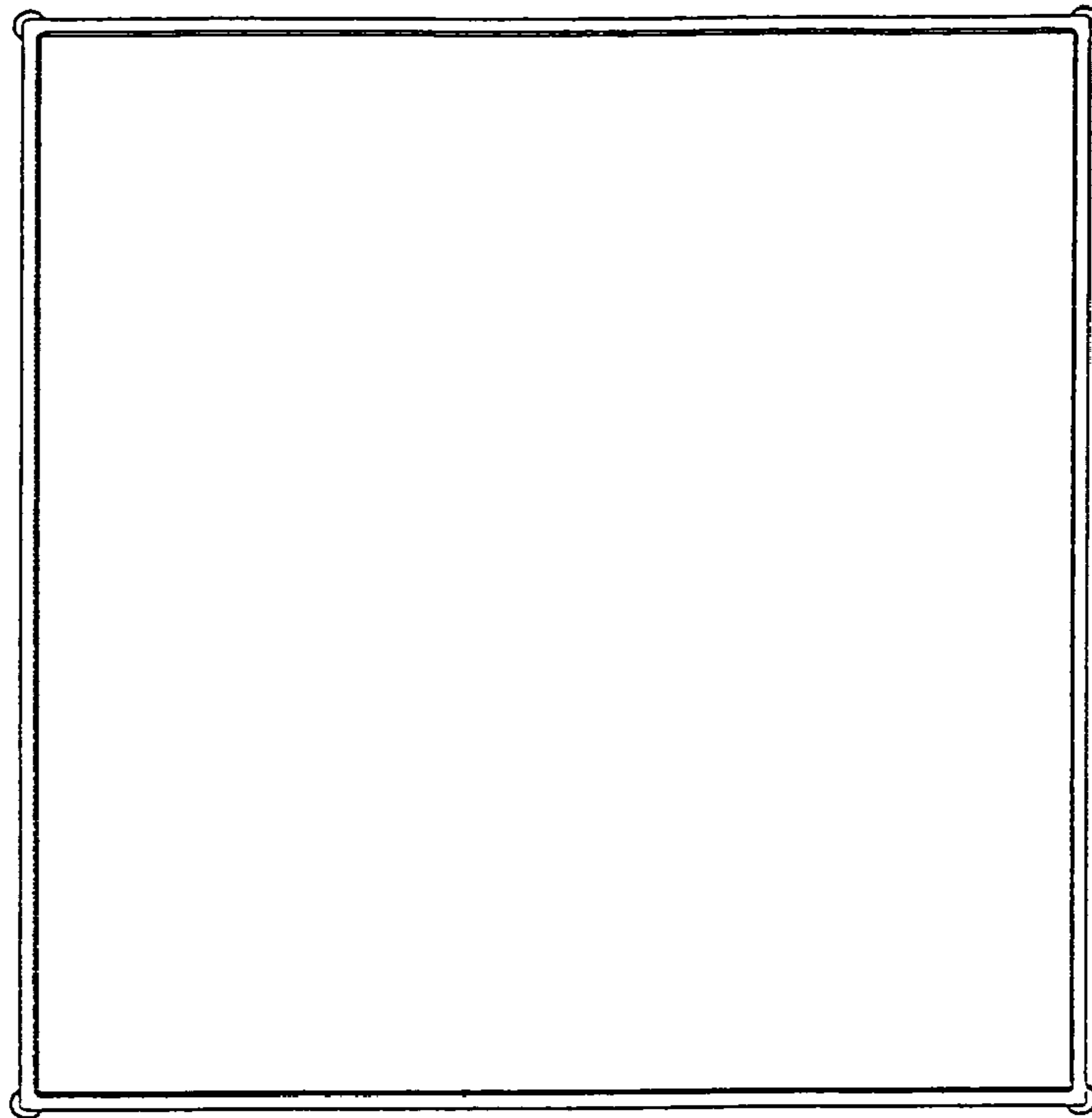

Fig.4

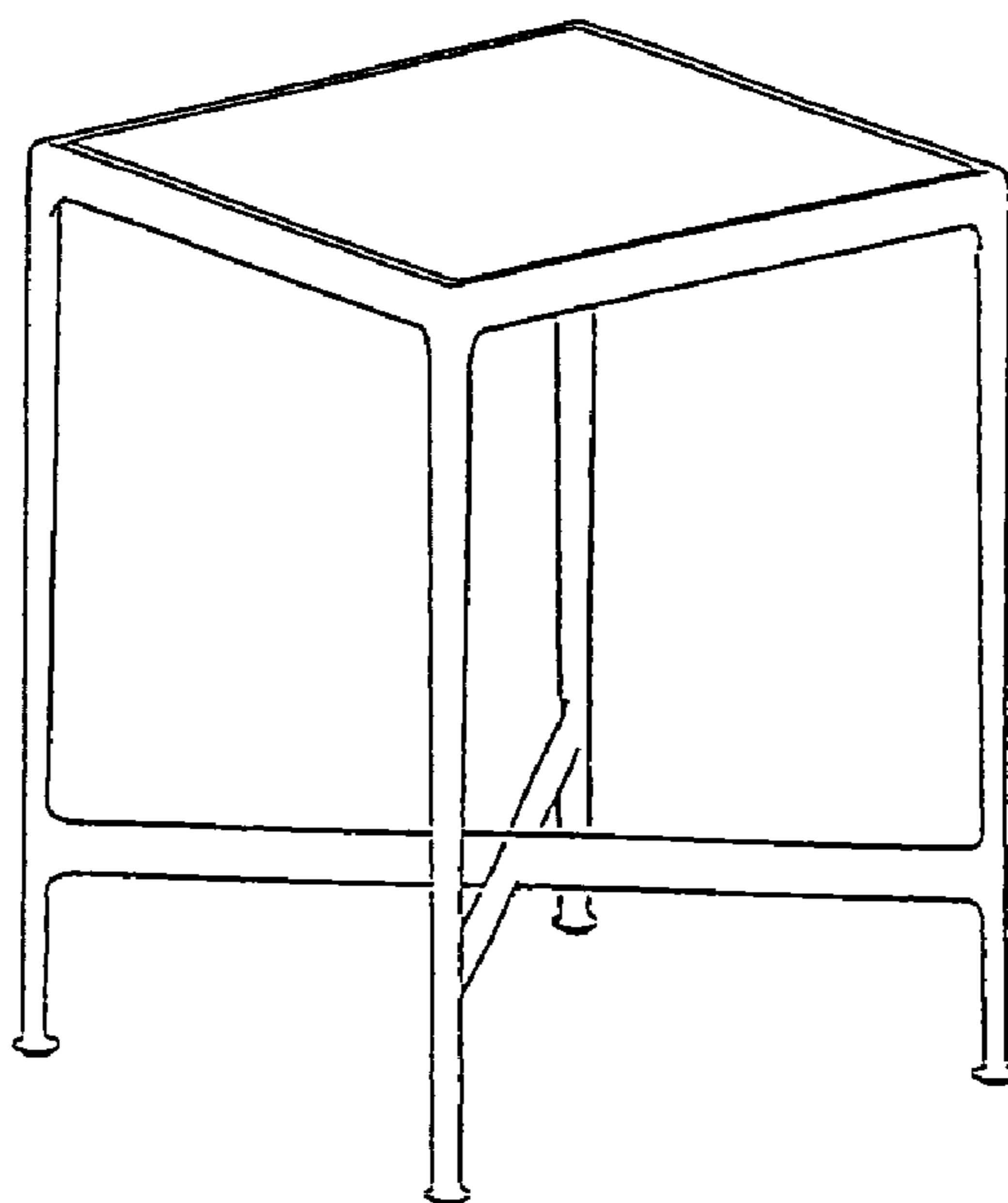

Fig. 5

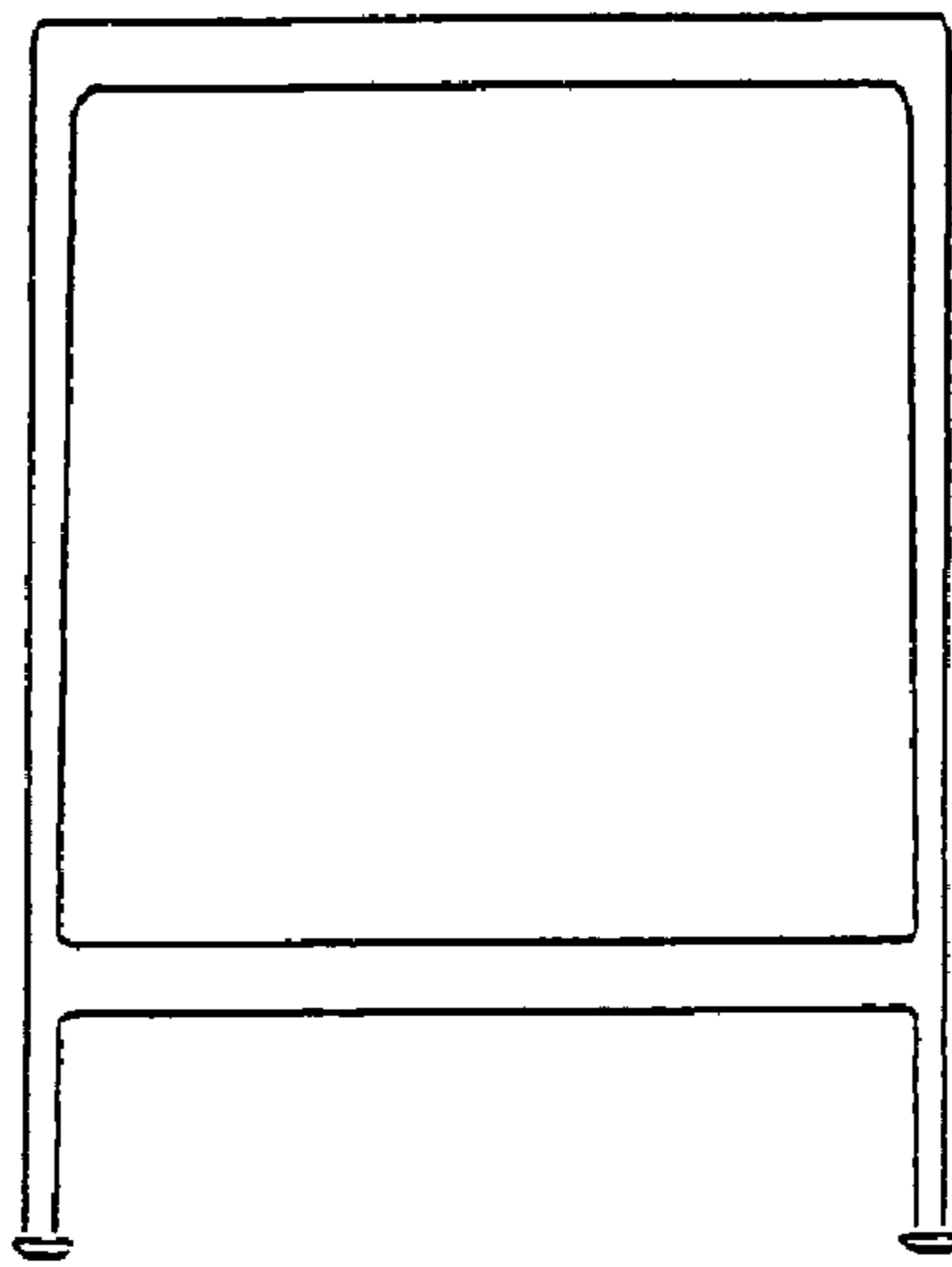

Fig. 6

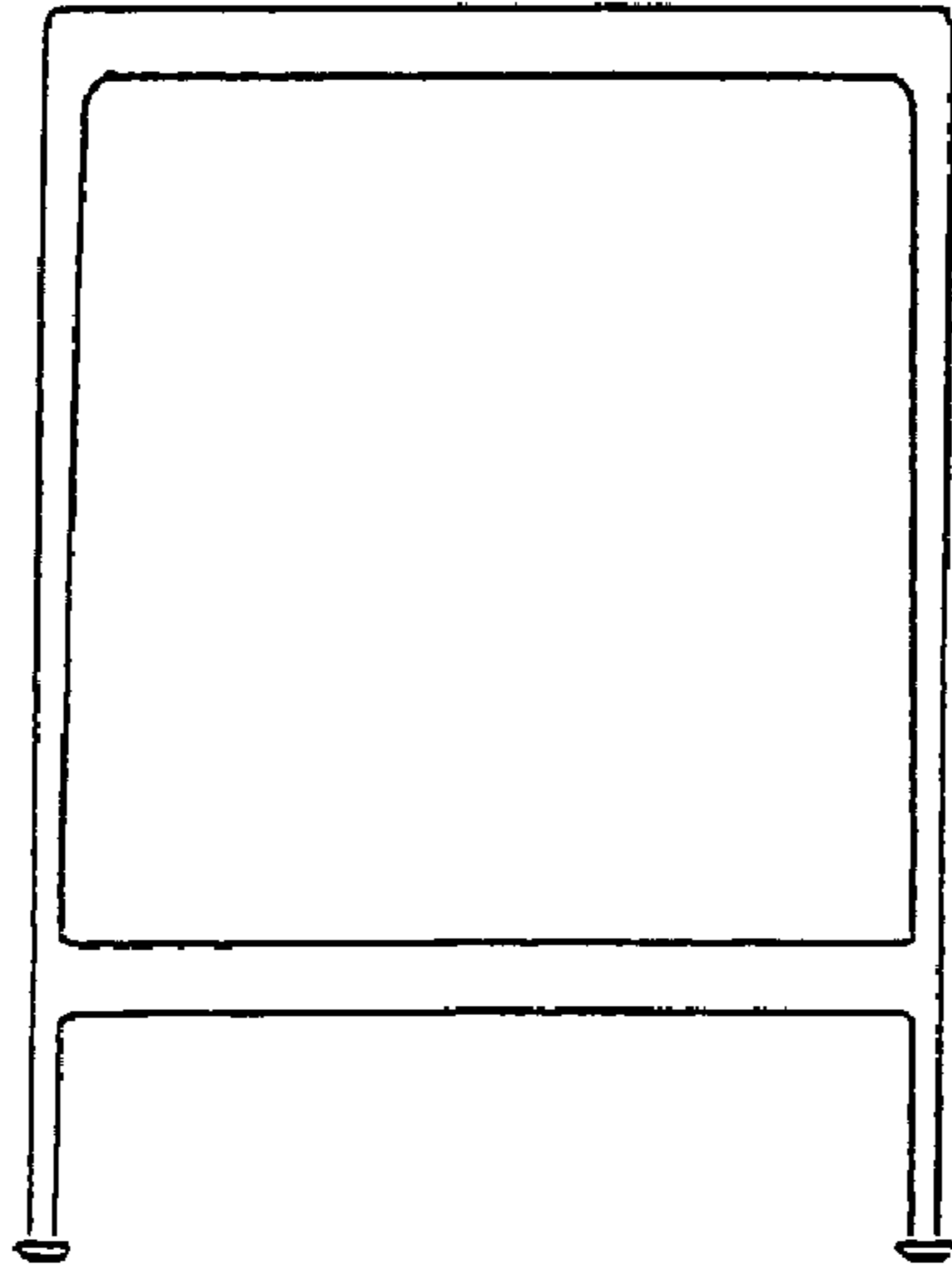

Fig. 7

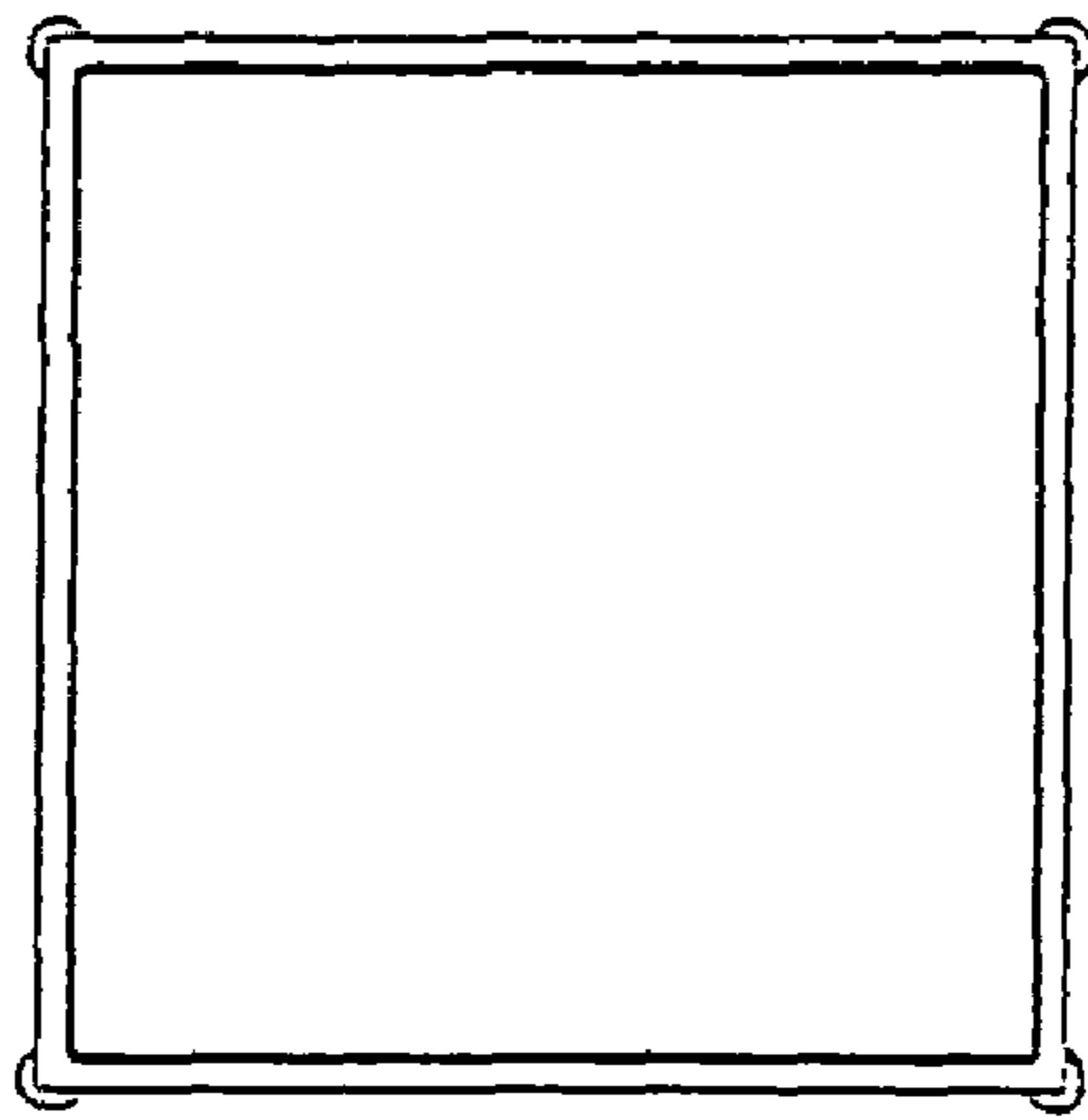

Fig. 8

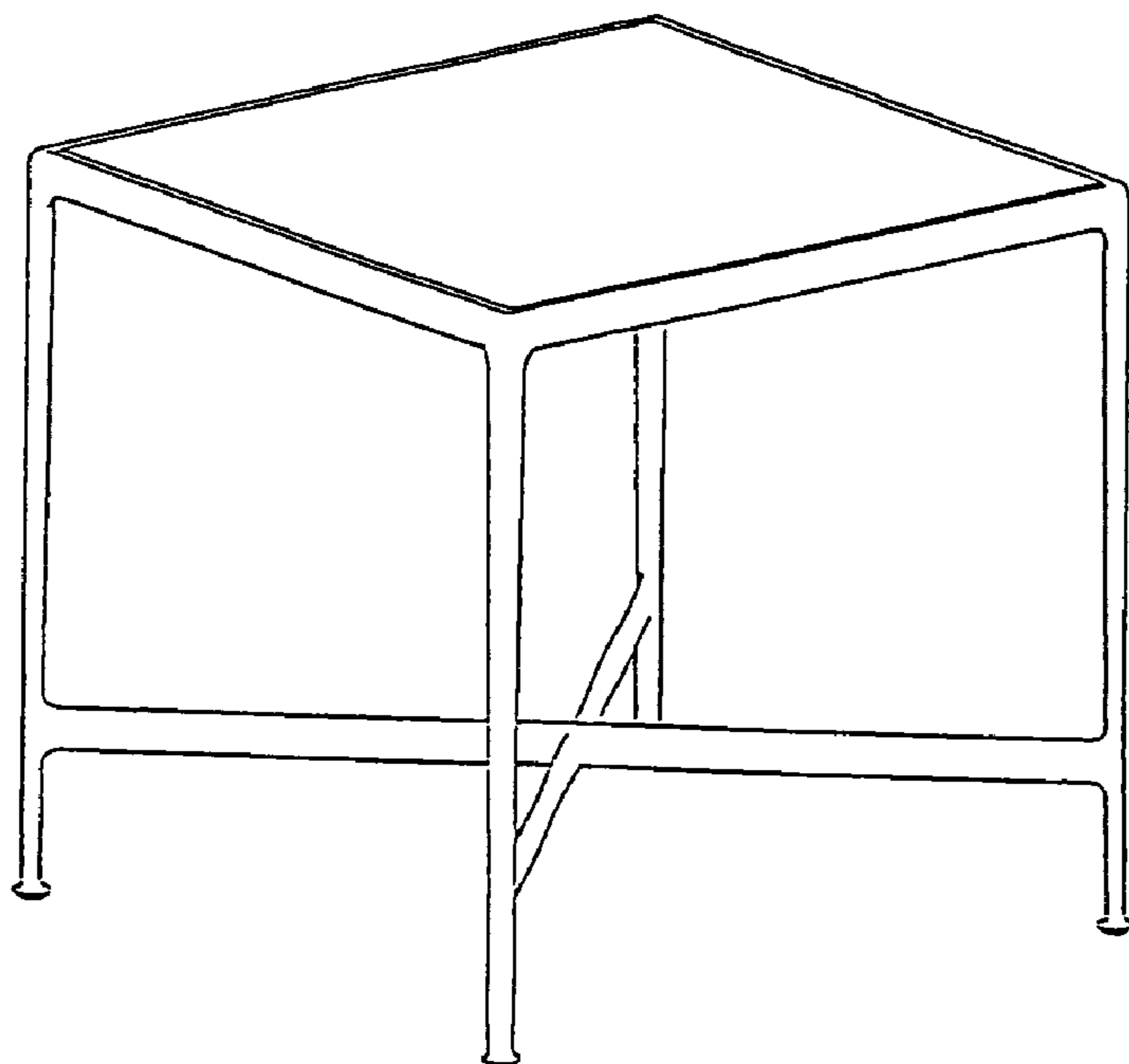

Fig. 9

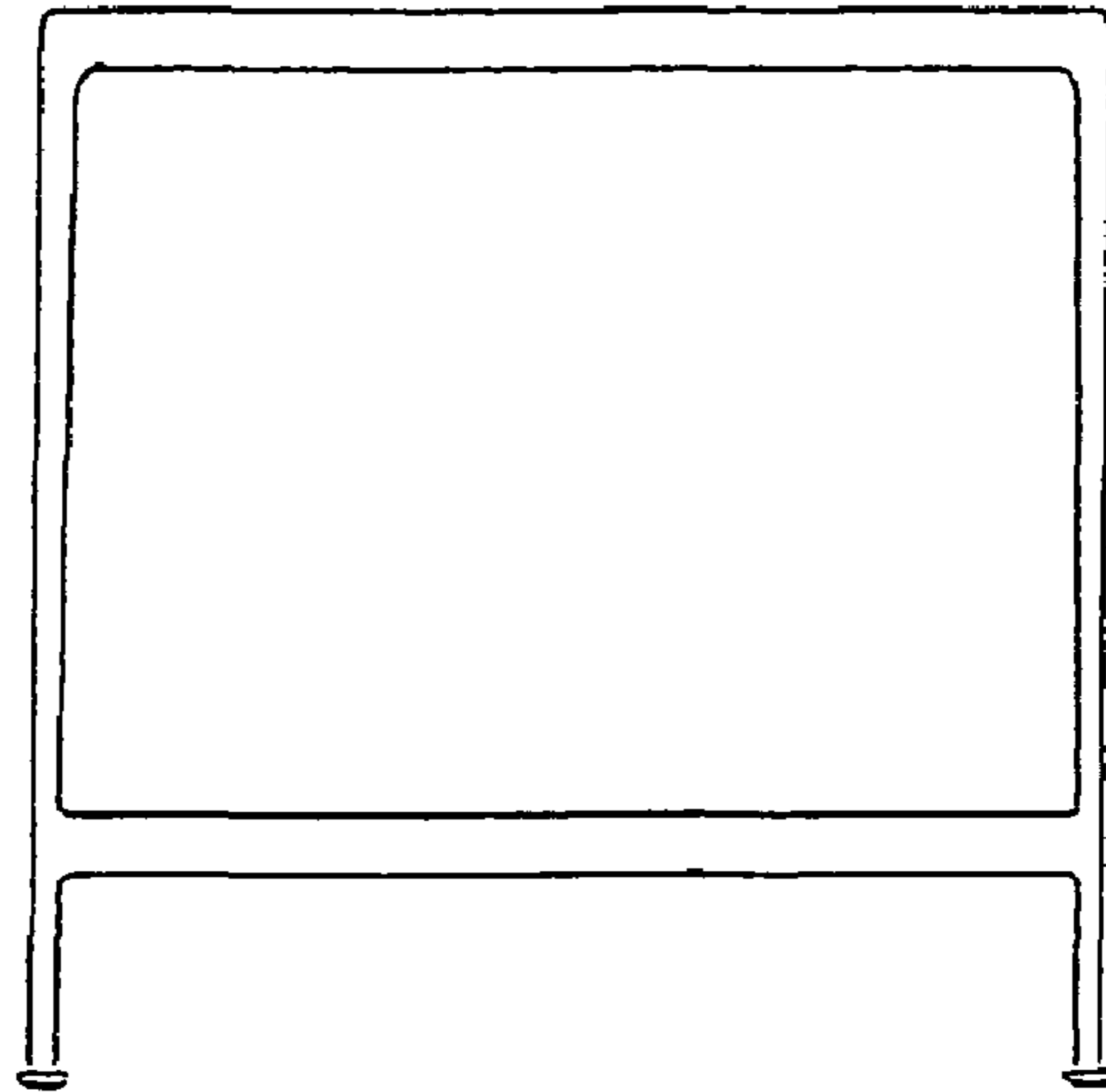

Fig. 10

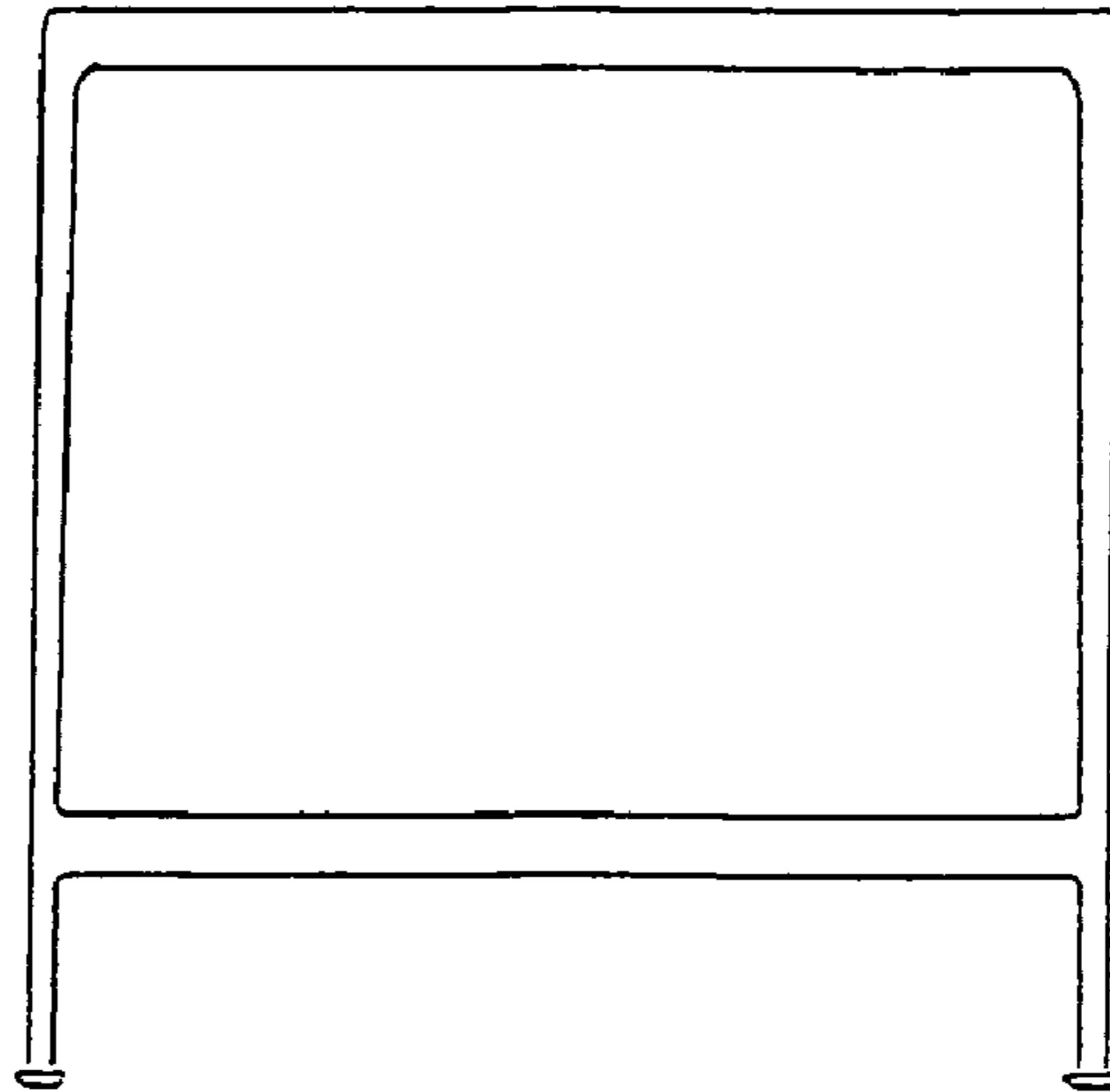

Fig. 11

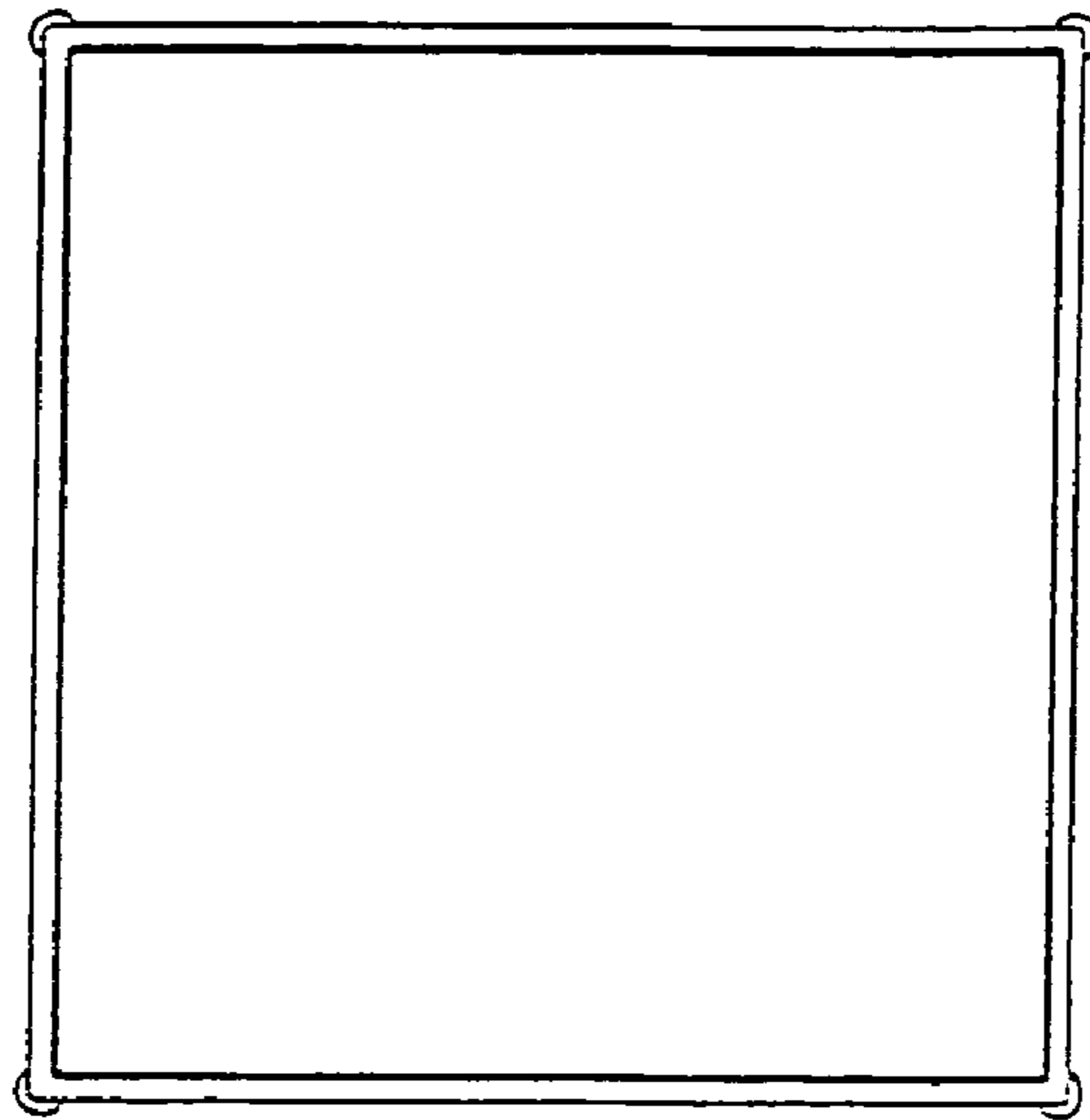

Fig. 12

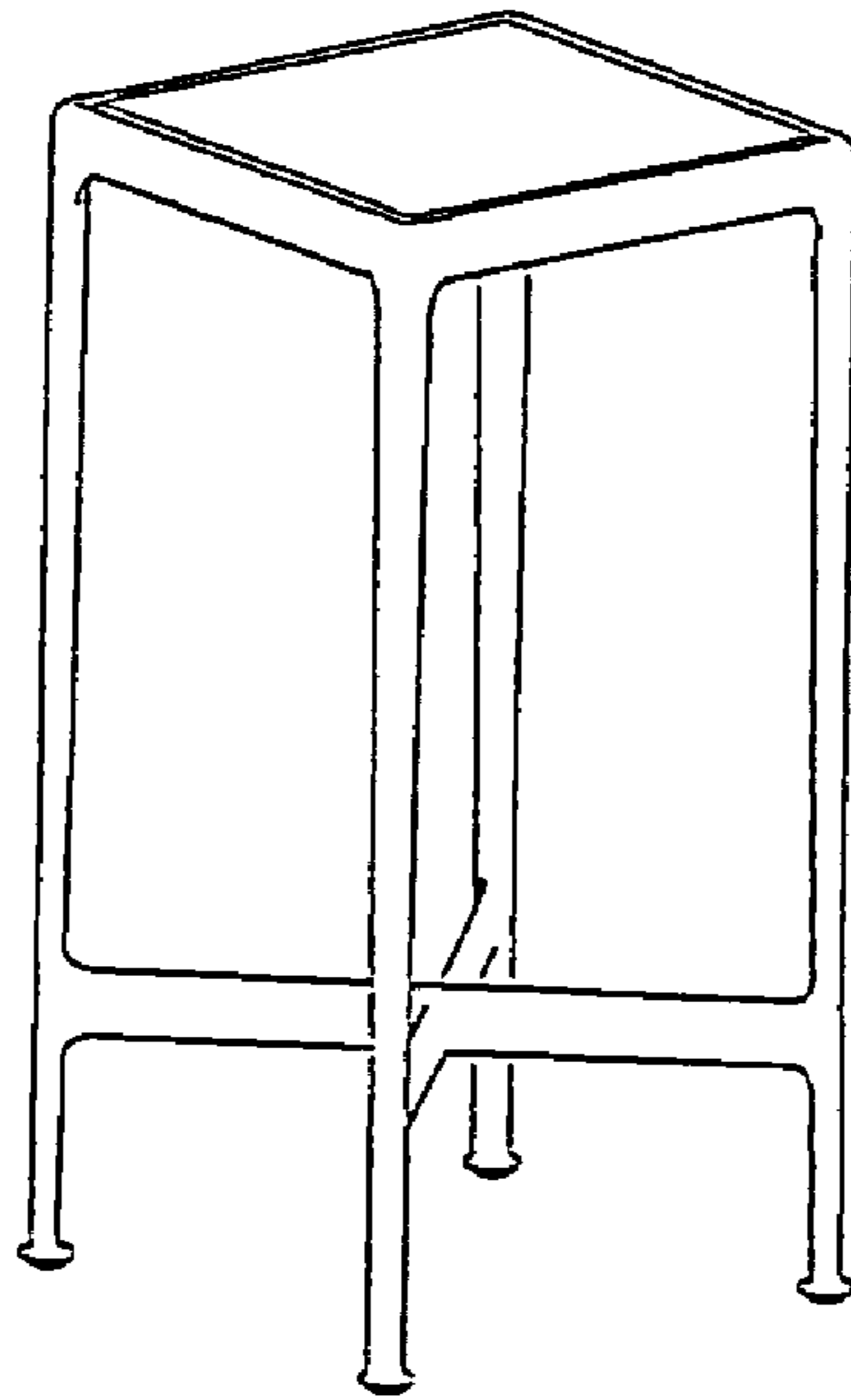

Fig. 13

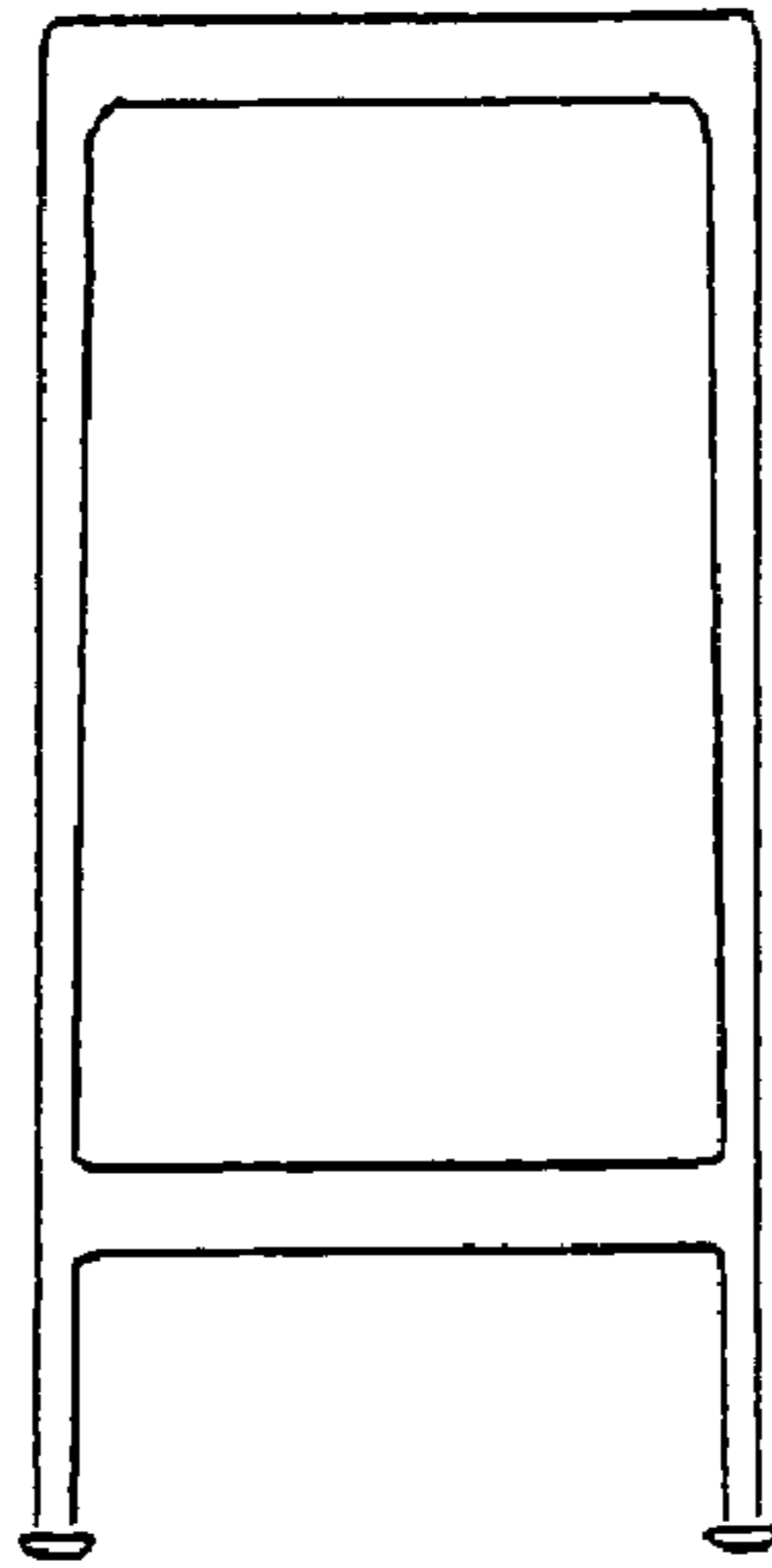

Fig. 14

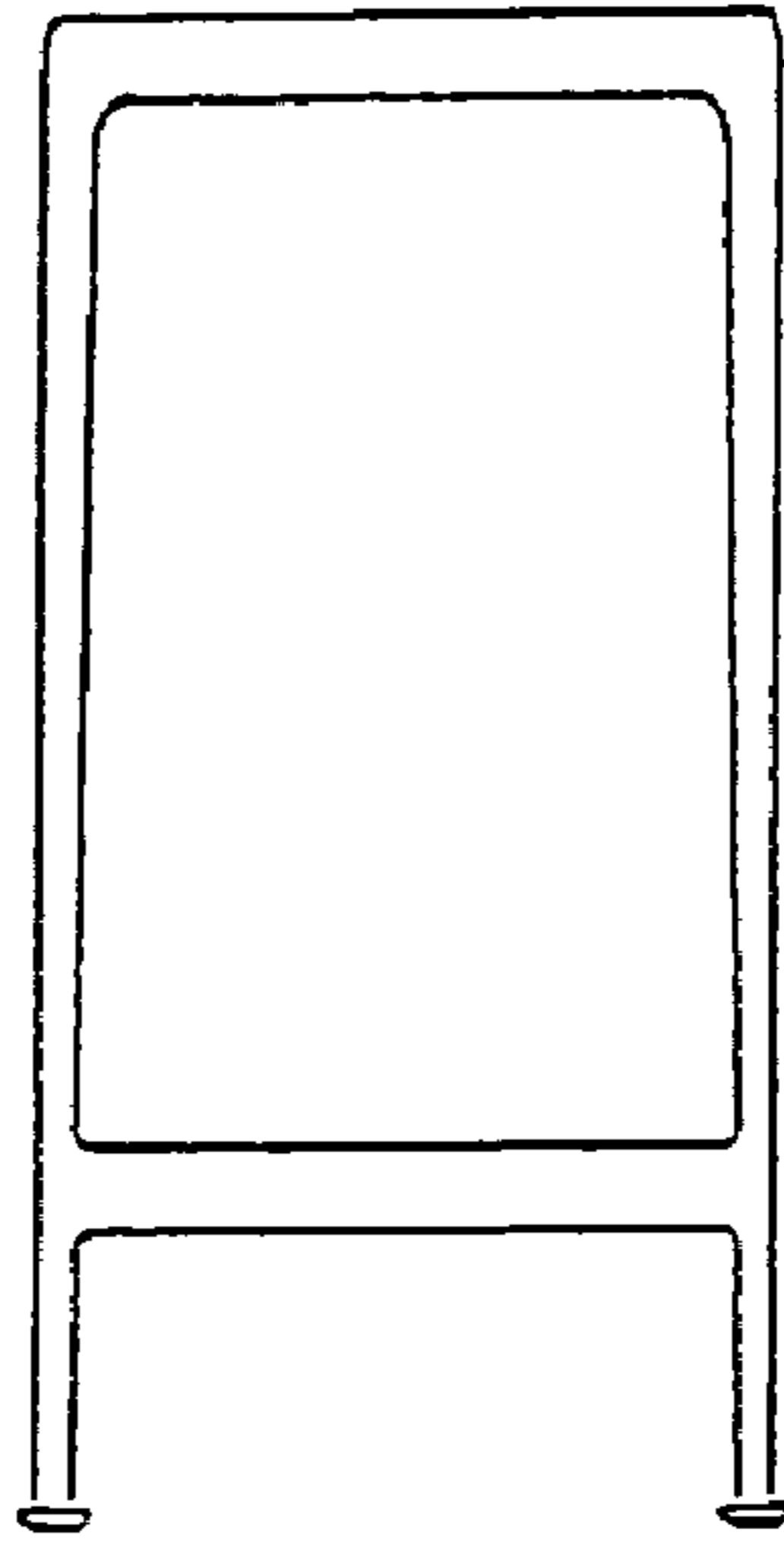

Fig. 15

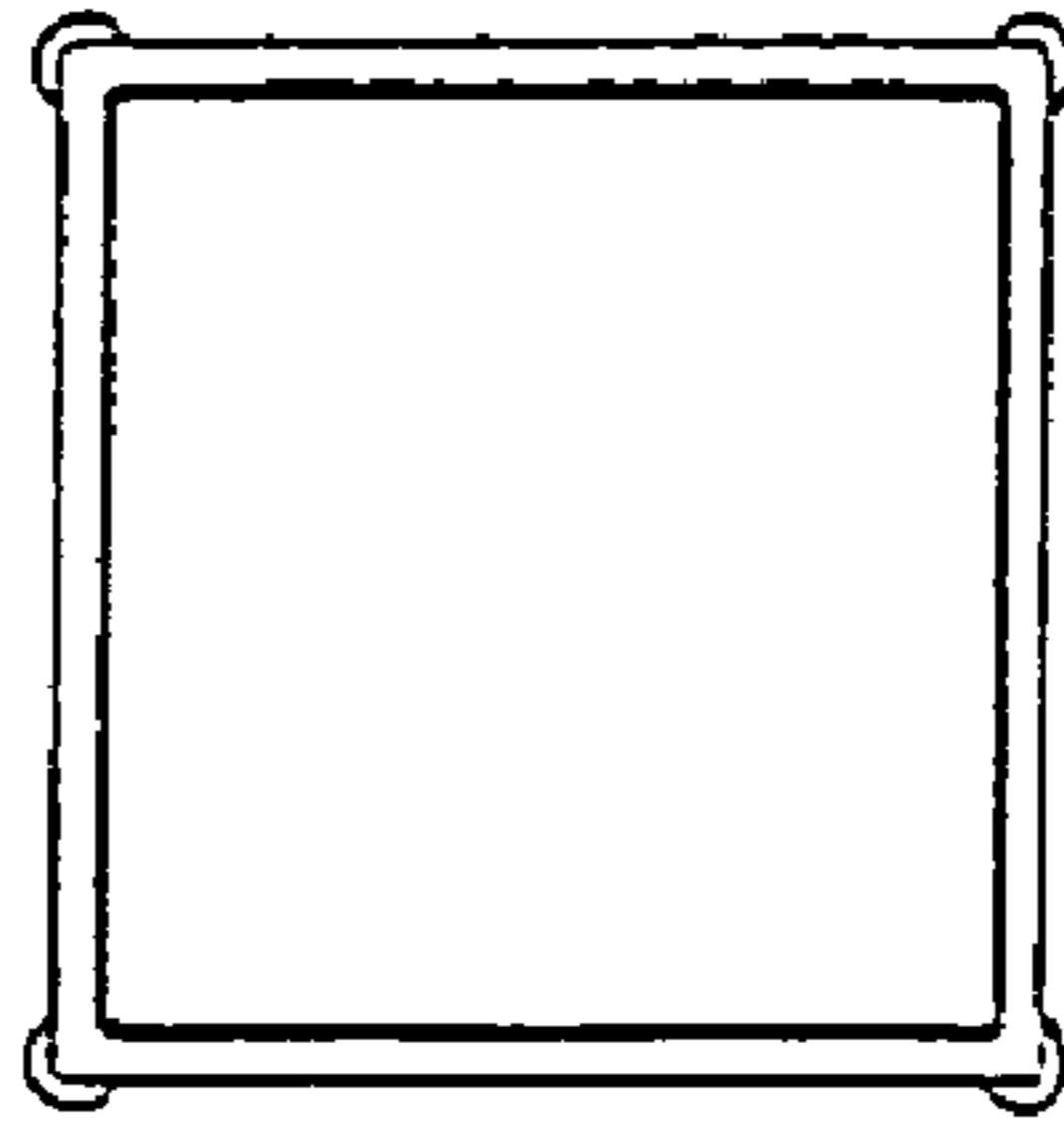

Fig. 16