



US00D662276S

(12) **United States Design Patent**
Villota et al.

(10) **Patent No.:** **US D662,276 S**
(45) **Date of Patent:** **** Jun. 26, 2012**

(54) **FOOD PRODUCT**

(75) Inventors: **Ricardo Villota**, Lake Zurich, IL (US);
Guillermo Haro, Skokie, IL (US)

(73) Assignee: **Kraft Foods Global Brands LLC**,
Northfield, IL (US)

(**) Term: **14 Years**

(21) Appl. No.: **29/394,290**

(22) Filed: **Jun. 15, 2011**

(51) **LOC (9) Cl.** **01-01**

(52) **U.S. Cl.** **D1/106**

(58) **Field of Classification Search** D1/100-199;
D11/68, 33, 106; D24/101-104, 211-212,
D24/9, 571, 575, 576, 396.4, 597-601, 200;
D10/9; D7/677, 676, 675, 672, 361, 359,
D7/354, 901; 426/104, 803, 134, 16, 20,
426/2, 635, 805, 138, 143; D6/597-601;
D21/707, 386; D25/119, 121; 119/706-711,
119/702; D9/613, 655; D28/8.2

See application file for complete search history.

(56) **References Cited**

U.S. PATENT DOCUMENTS

D132,530 S *	5/1942	Zentner	D1/128
D167,087 S *	6/1952	Kyte	D7/599
D189,660 S *	1/1961	Vermlyen	D1/113
D298,296 S *	11/1988	Washburn et al.	D7/553.8
D321,082 S *	10/1991	Meyers et al.	D1/113
D343,943 S *	2/1994	Mottur et al.	D1/111
D355,975 S *	3/1995	Patoskie et al.	D1/106
D403,267 S *	12/1998	Burke	D11/134
D477,124 S *	7/2003	Cornwell et al.	D1/130
D483,227 S *	12/2003	Oas	D7/544
D509,401 S *	9/2005	Barnard et al.	D7/354
D509,641 S *	9/2005	Kerdoon	D1/115
D548,057 S *	8/2007	Kelleghan	D8/356

D610,877 S *	3/2010	Cooper	D7/556
D614,826 S *	5/2010	Nakan	D1/106
D631,278 S *	1/2011	Curtis	D6/588

FOREIGN PATENT DOCUMENTS

EM 001967787-0001 * 12/2011

OTHER PUBLICATIONS

Brochure of pasta shapes. <https://www.funpastafundraising.com/shop/products.php?id=2955&&th=2&&p=30>, 16 pages. (Tailgate and Celebrate Pasta believed to be on sale at least by about Mar. 2011.).

(Continued)

Primary Examiner — Barbara Fox

(74) *Attorney, Agent, or Firm* — Fitch, Even, Tabin & Flannery, LLP

(57) **CLAIM**

We claim the ornamental design for a food product, as shown and described.

DESCRIPTION

FIG. 1 is a perspective view of a food product showing our new design, comprising a football-shaped food product; FIG. 2 is a back elevation view of the football-shaped food product of FIG. 1; FIG. 3 is a front elevation view of the football-shaped food product of FIG. 1; FIG. 4 is a left side elevation view of the football-shaped food product of FIG. 1; FIG. 5 is a right side elevation view of the football-shaped food product of FIG. 1; FIG. 6 is a top plan view of the football-shaped food product of FIG. 1; and, FIG. 7 is a bottom plan view of the football-shaped food product of FIG. 1.

1 Claim, 2 Drawing Sheets

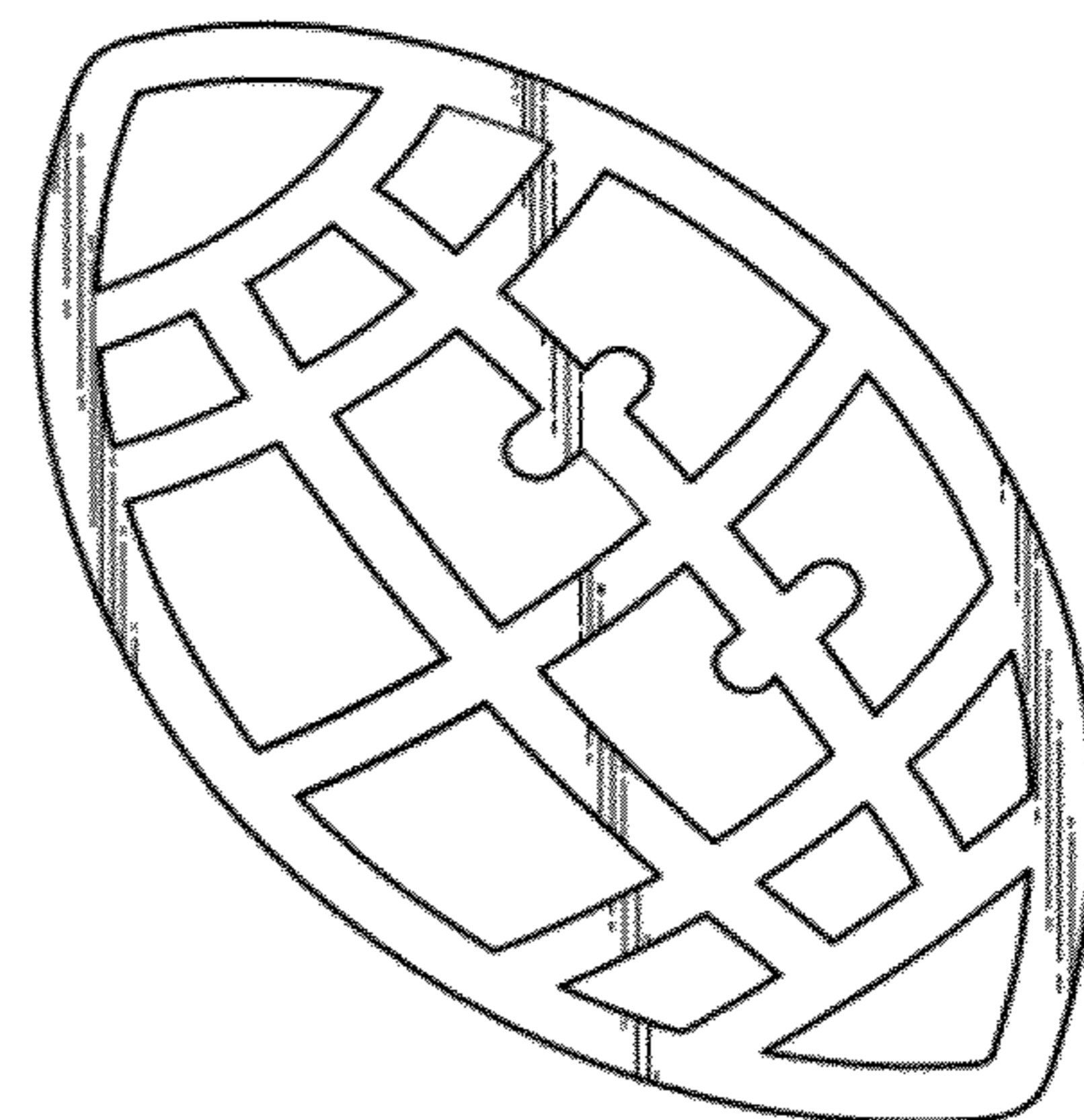
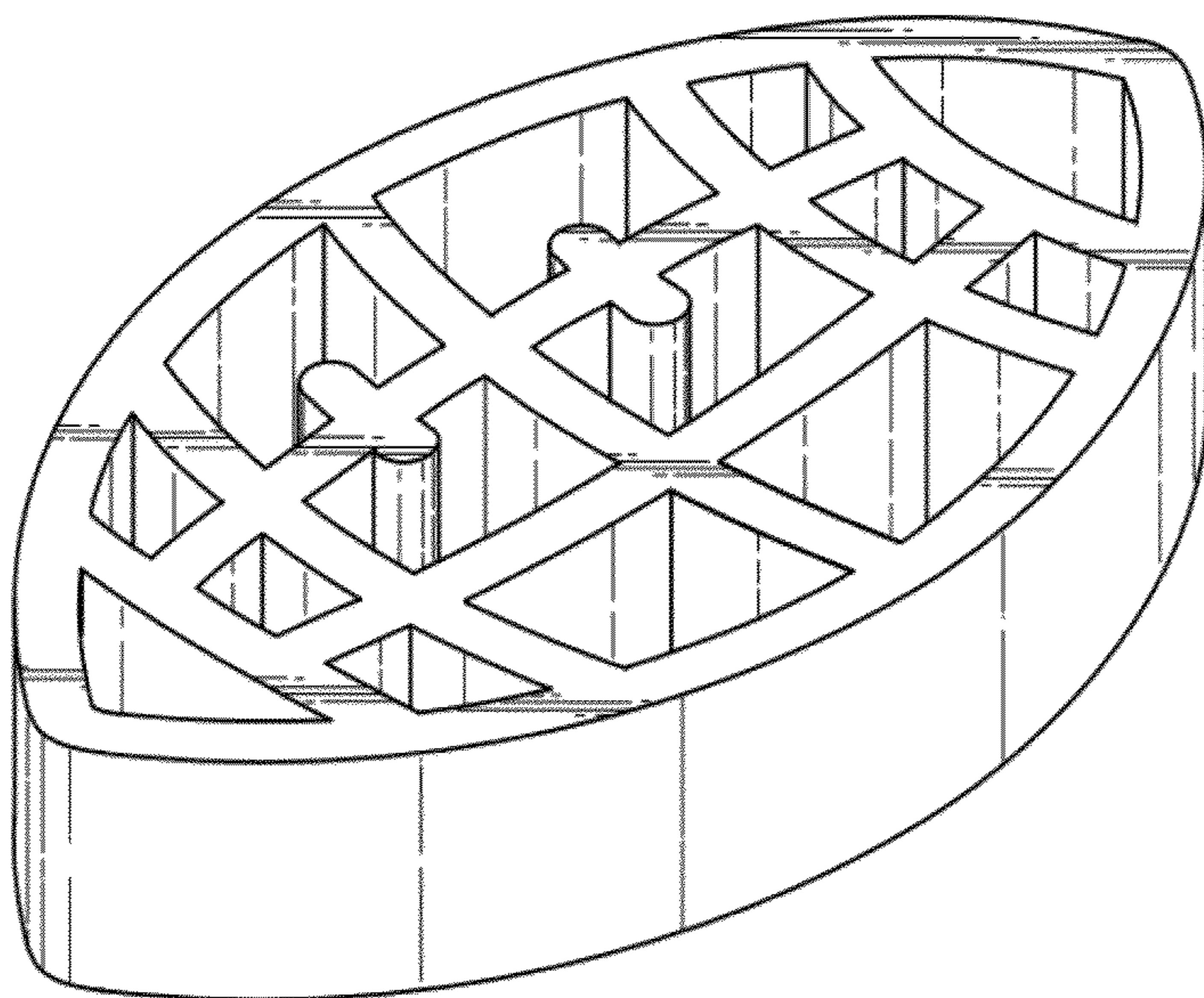

OTHER PUBLICATIONS

Photo of Tailgate and Celebrate Pasta. <http://www.teamtailgateshop.com/pstail750.html>, 3 pages (Tailgate and Celebrate Pasta believed to be on sale at least by about Mar. 2011.).

Photo of Tailgate and Celebrate Pasta. <https://pastashoppe.com/product.php?id=52&&c=2>, 2 pages.(Tailgate and Celebrate Pasta believed to be on sale at least by about Mar. 2011.).

* cited by examiner

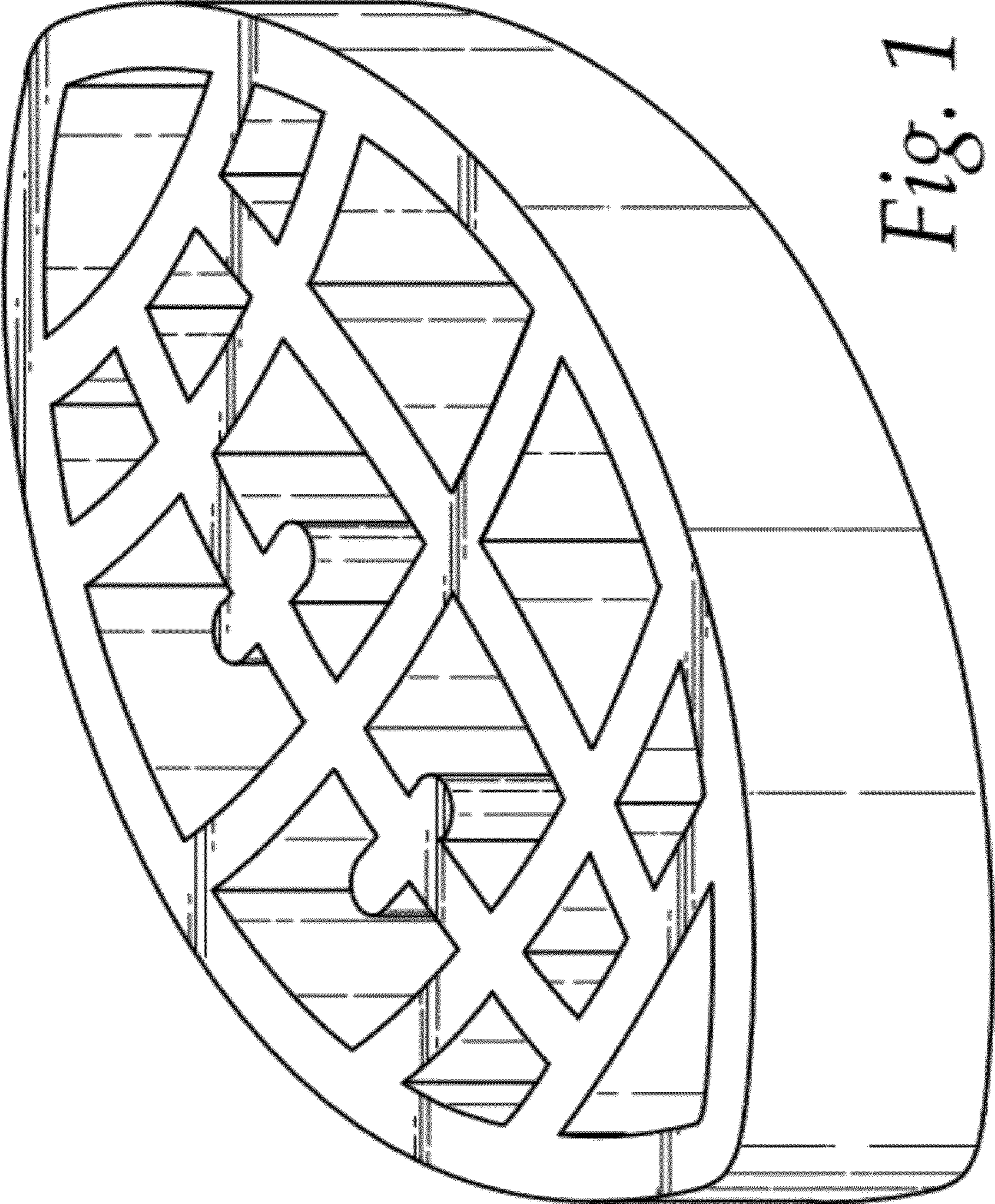

Fig. 2

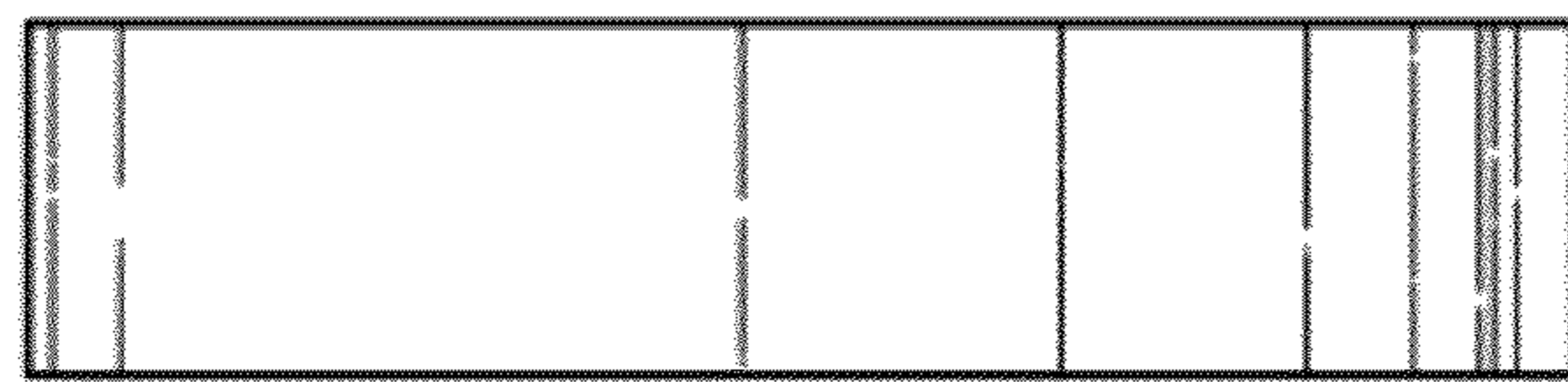
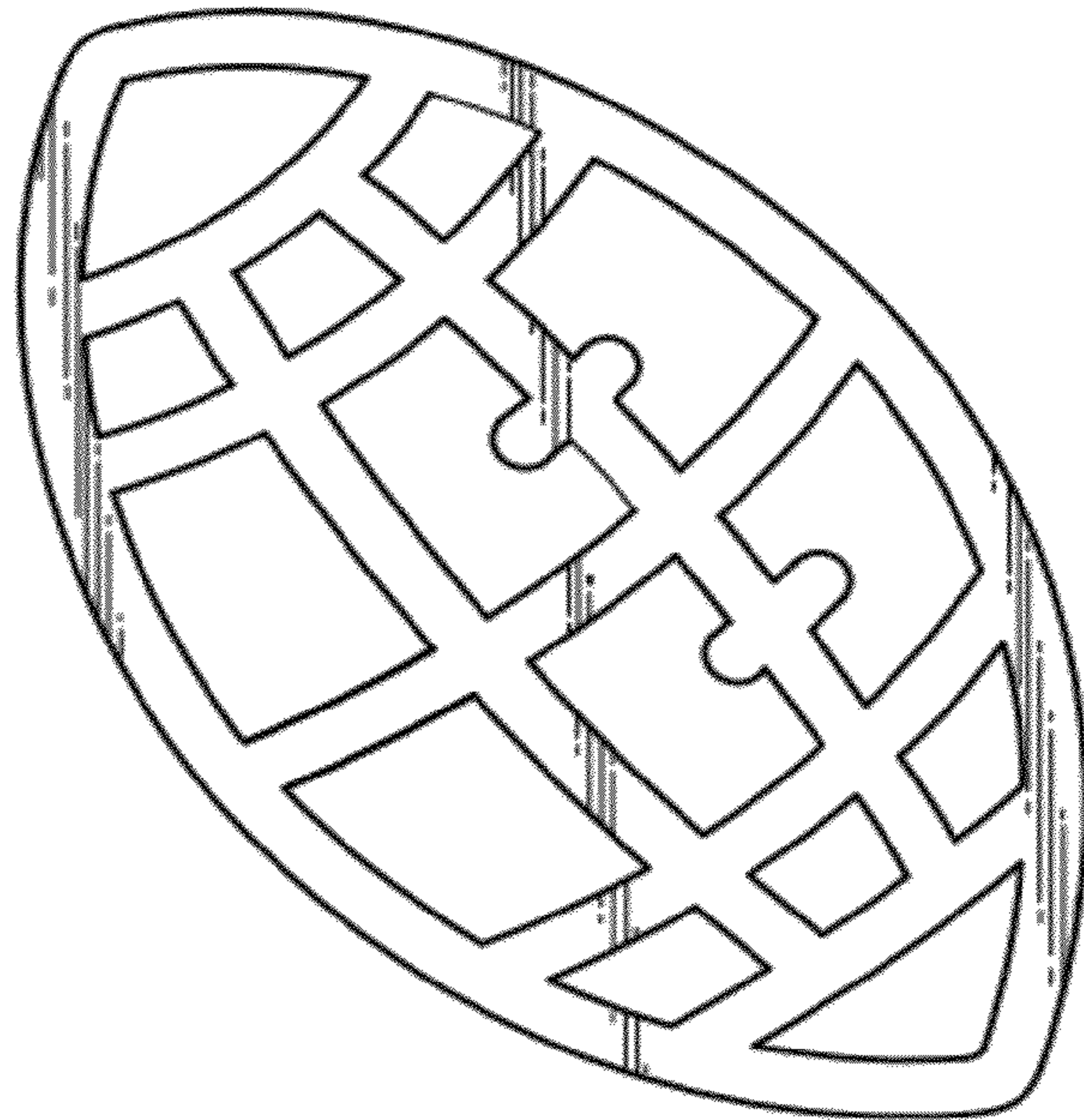

Fig. 6

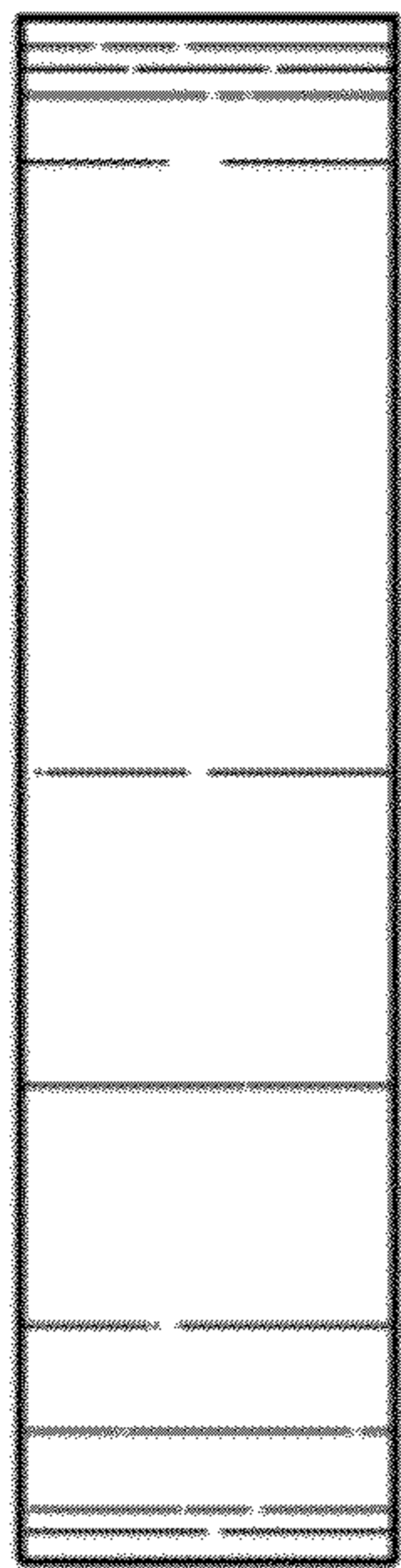

Fig. 4

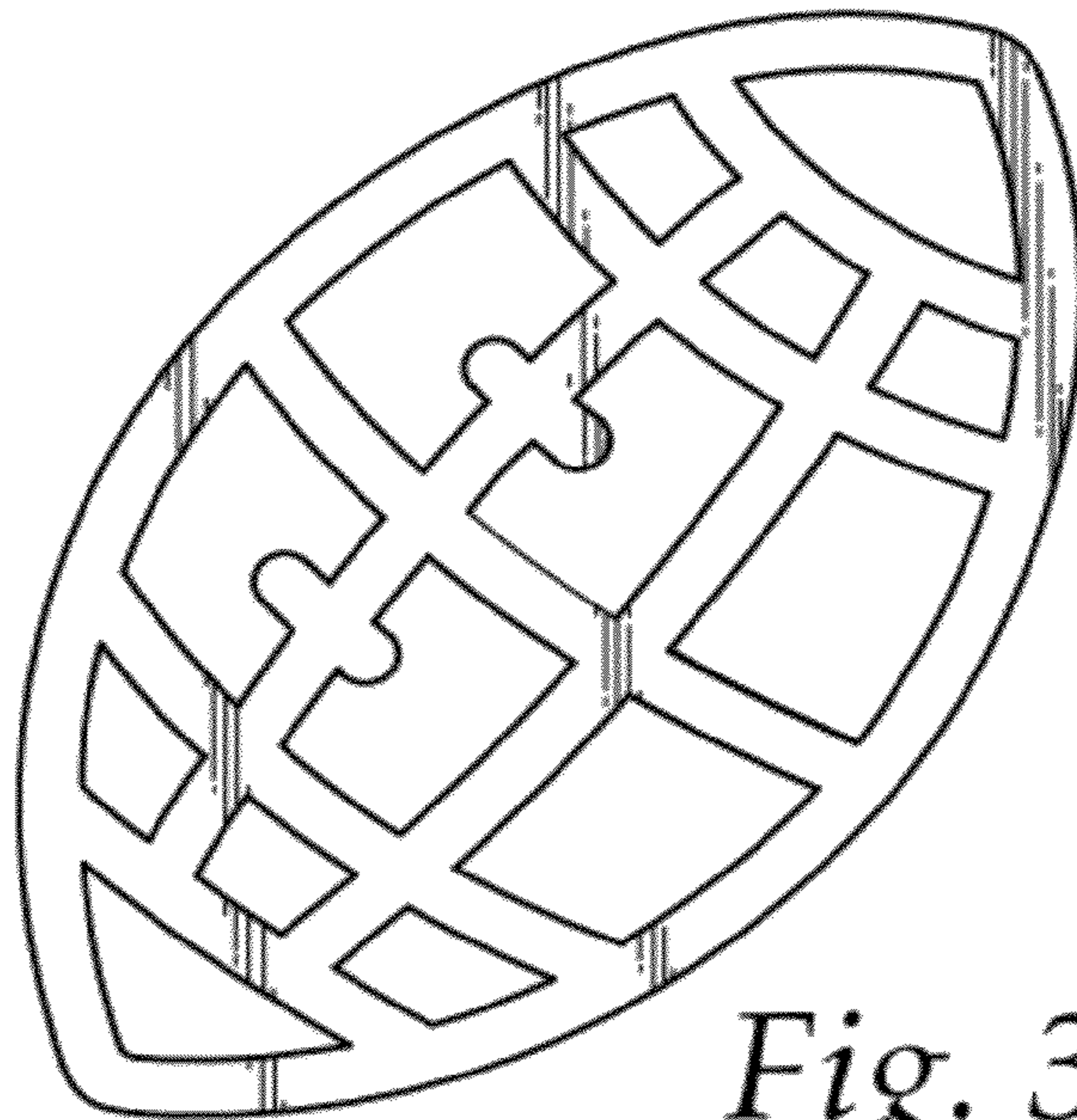

Fig. 3

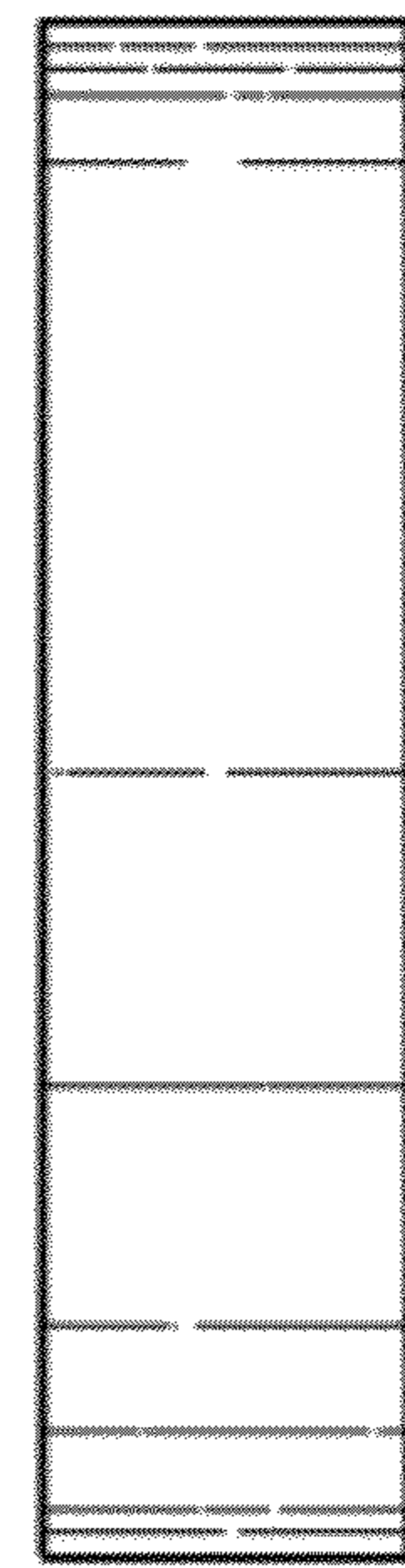

Fig. 5

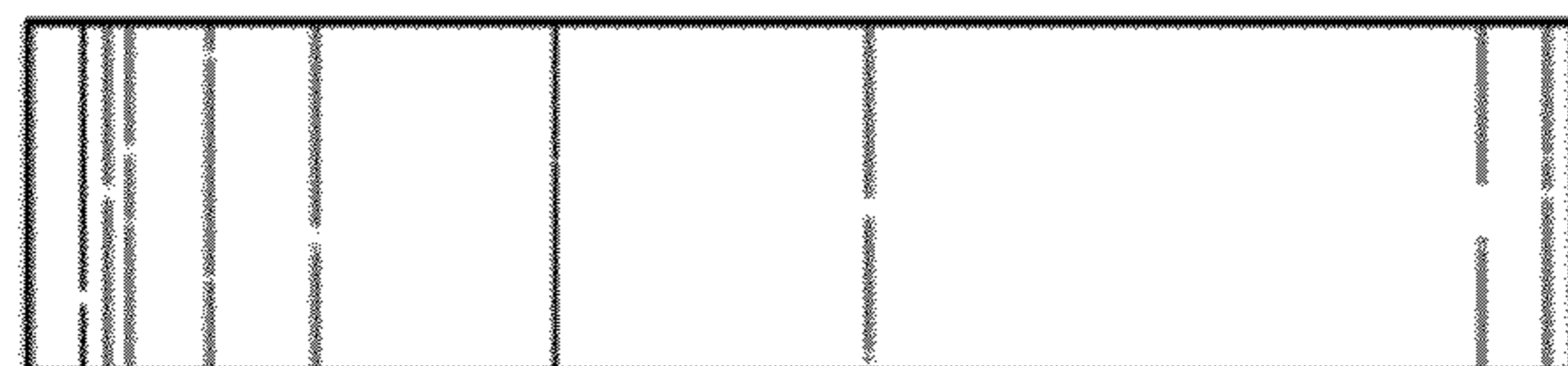

Fig. 7