



US00D662270S

(12) **United States Design Patent**
Kim

(10) **Patent No.:** **US D662,270 S**
(45) **Date of Patent:** **** Jun. 19, 2012**

(54) **VACUUM CLEANER**

(75) Inventor: **Kyung Tae Kim**, Kyungki-Do (KR)

(73) Assignee: **Samsung Electronics Co., Ltd.**,
Suwon-si (KR)

(**) Term: **14 Years**

(21) Appl. No.: **29/368,165**

(22) Filed: **Aug. 19, 2010**

(51) **LOC (9) Cl.** **15-05**

(52) **U.S. Cl.** **D32/22**

(58) **Field of Classification Search** D32/22,
D32/31, 34; 55/337, 429, 459.1, DIG. 2,
55/DIG. 3; 15/386, 320, 350, 353, 361, 347,
15/410-411, 327.1, 329, 383, 398, 366, 182-183,
15/179, 344, 374, 392, 339, 402, 415.1, 419,
15/310, 4.52; 119/628

See application file for complete search history.

(56) **References Cited**

U.S. PATENT DOCUMENTS

D455,530 S *	4/2002	Fujii	D32/22
D462,813 S *	9/2002	Nakano et al.	D32/22
D463,078 S *	9/2002	Harada	D32/22
D494,720 S *	8/2004	Rosenzweig et al.	D32/31
D510,465 S *	10/2005	Takahashi et al.	D32/22
D532,944 S *	11/2006	Choi	D32/22
D533,697 S *	12/2006	Ikeno et al.	D32/22
D535,069 S *	1/2007	Breit	D32/22

D535,070 S *	1/2007	Shin	D32/22
D553,814 S *	10/2007	Parr et al.	D32/22
D565,815 S *	4/2008	Dyson et al.	D32/22
D587,870 S *	3/2009	Baek et al.	D32/22
7,600,291 B2 *	10/2009	Choi	15/329
D607,160 S *	12/2009	Yu et al.	D32/22
D610,317 S *	2/2010	Lee et al.	D32/22
D610,318 S *	2/2010	Shin	D32/22
7,836,546 B2 *	11/2010	Yoo et al.	15/352
D633,264 S *	2/2011	Lee	D32/22
7,937,802 B2 *	5/2011	Yoo et al.	15/329
2007/0209147 A1 *	9/2007	Krebs et al.	15/347
2009/0178233 A1 *	7/2009	Yoo	15/350

* cited by examiner

Primary Examiner — Ruth McInroy

(74) *Attorney, Agent, or Firm* — Ladas & Parry LLP

(57) **CLAIM**

I claim the ornamental design for a vacuum cleaner, as shown and described.

DESCRIPTION

FIG. 1 is a top, front and right-side perspective view of a vacuum cleaner showing our new design; FIG. 2 is a front elevational view thereof; FIG. 3 is a rear elevational view thereof; FIG. 4 is a left side elevational view thereof; FIG. 5 is a right side elevational view thereof; FIG. 6 is a top plan view thereof; and, FIG. 7 is a bottom plan view thereof. The details shown in broken lines form no part of the claimed design.

1 Claim, 6 Drawing Sheets

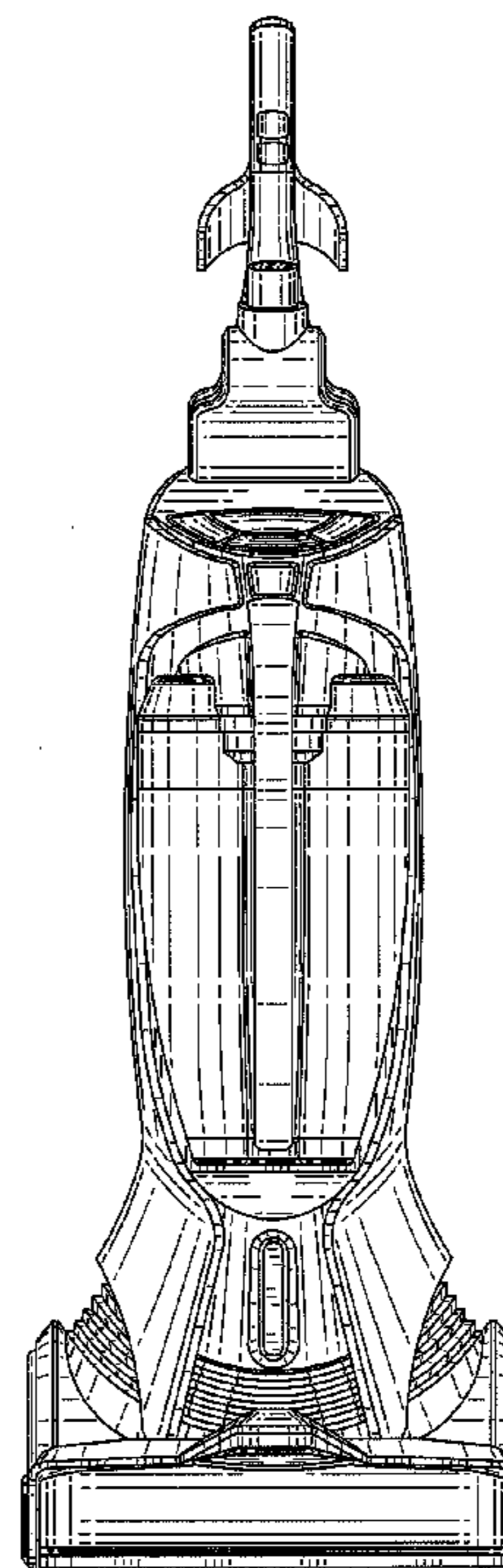
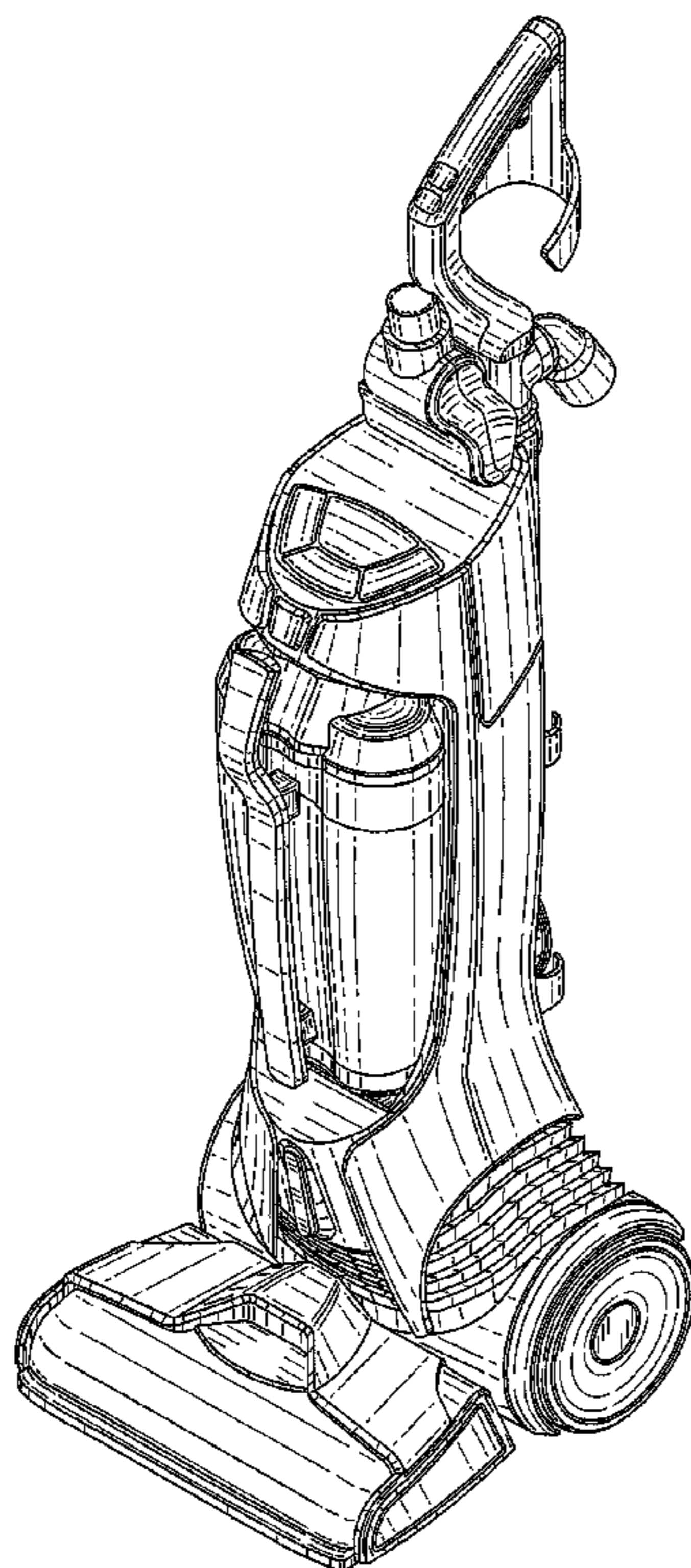

FIG. 1

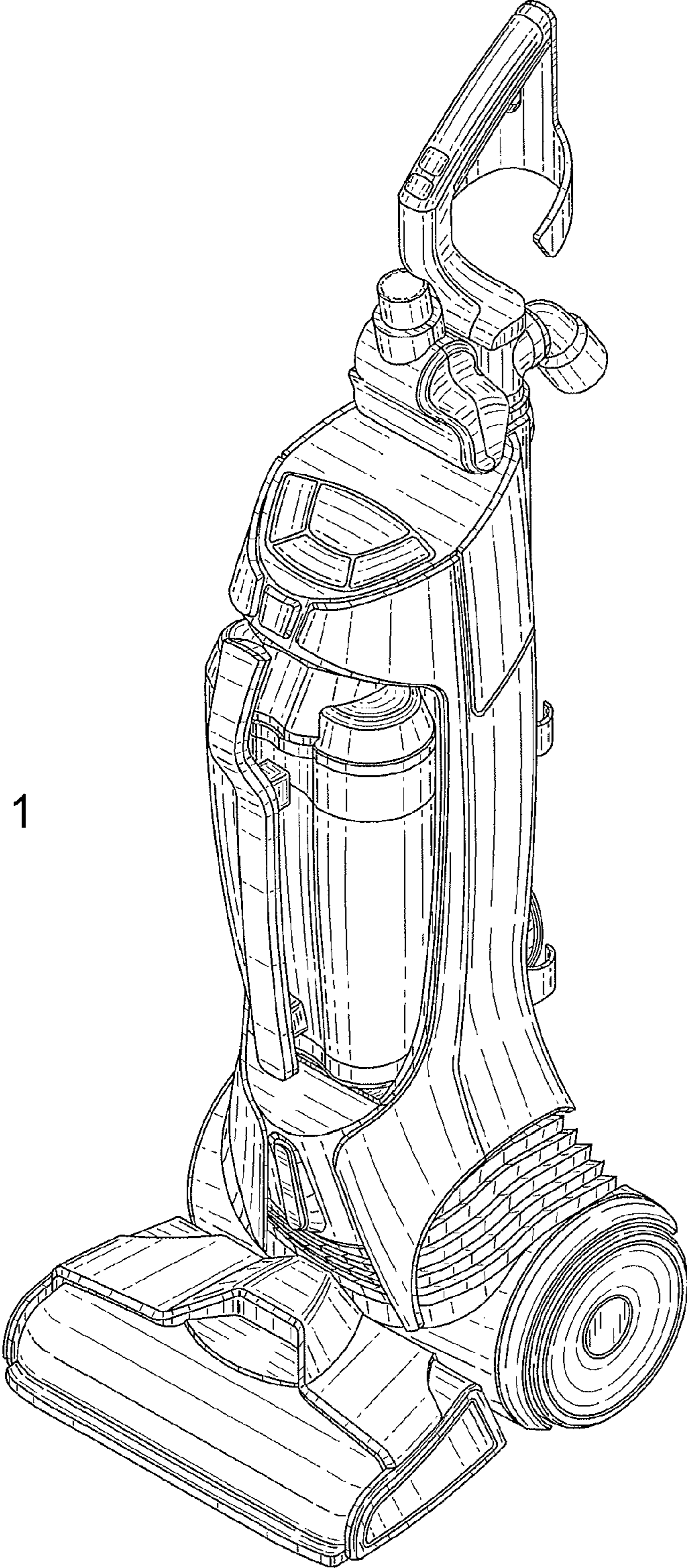

FIG. 2

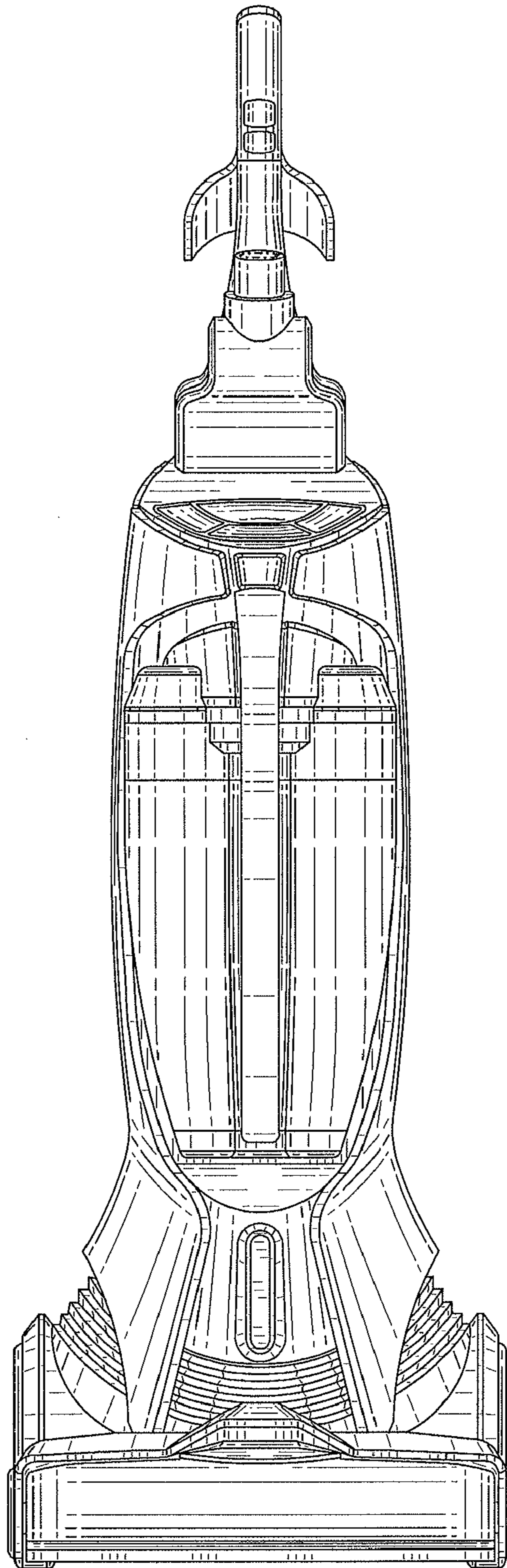
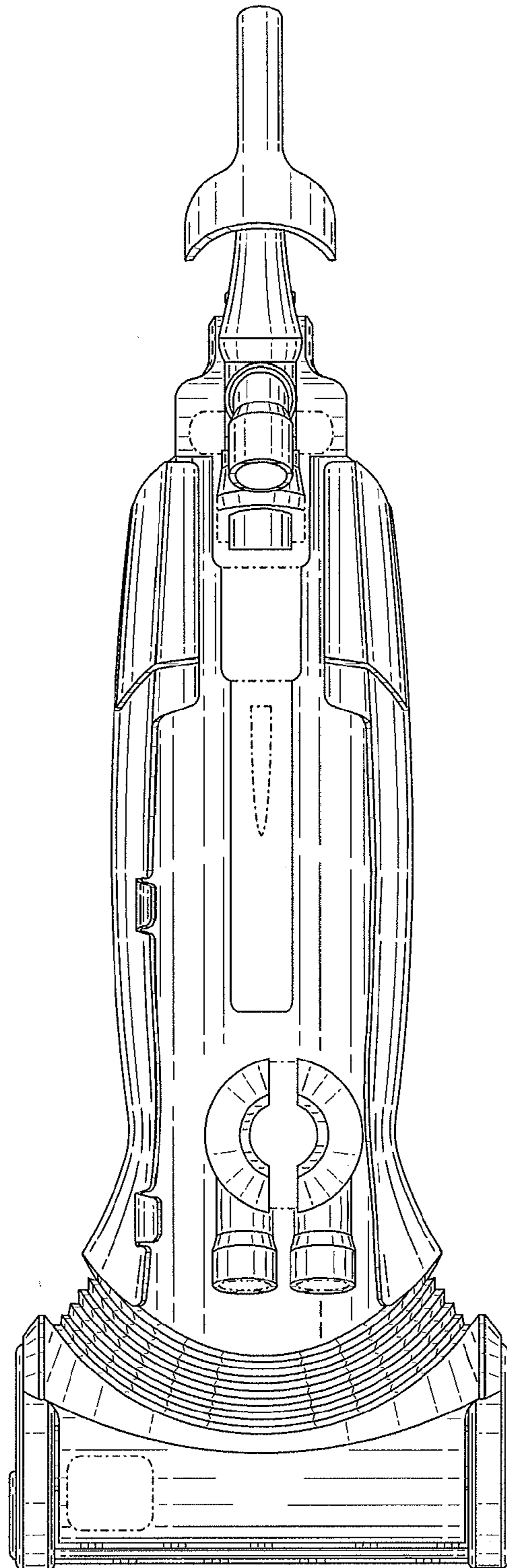

FIG. 3



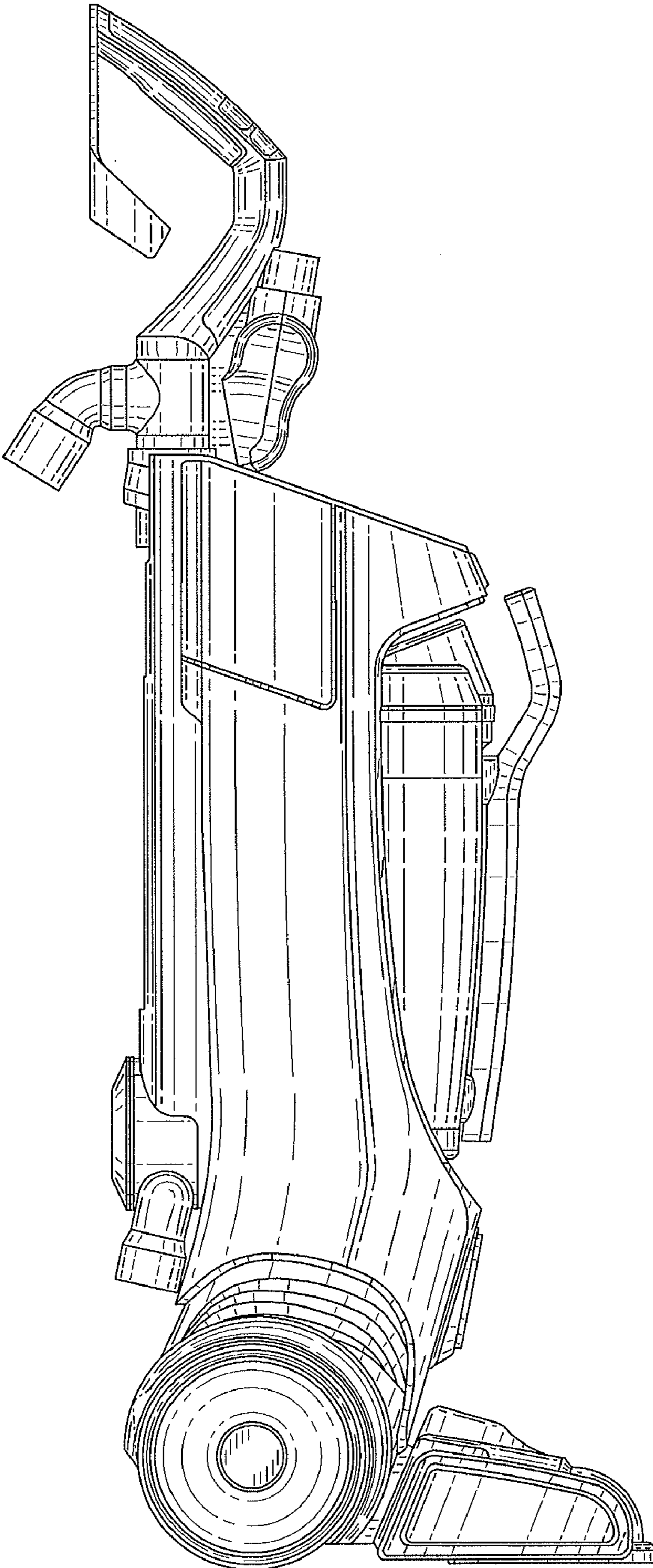
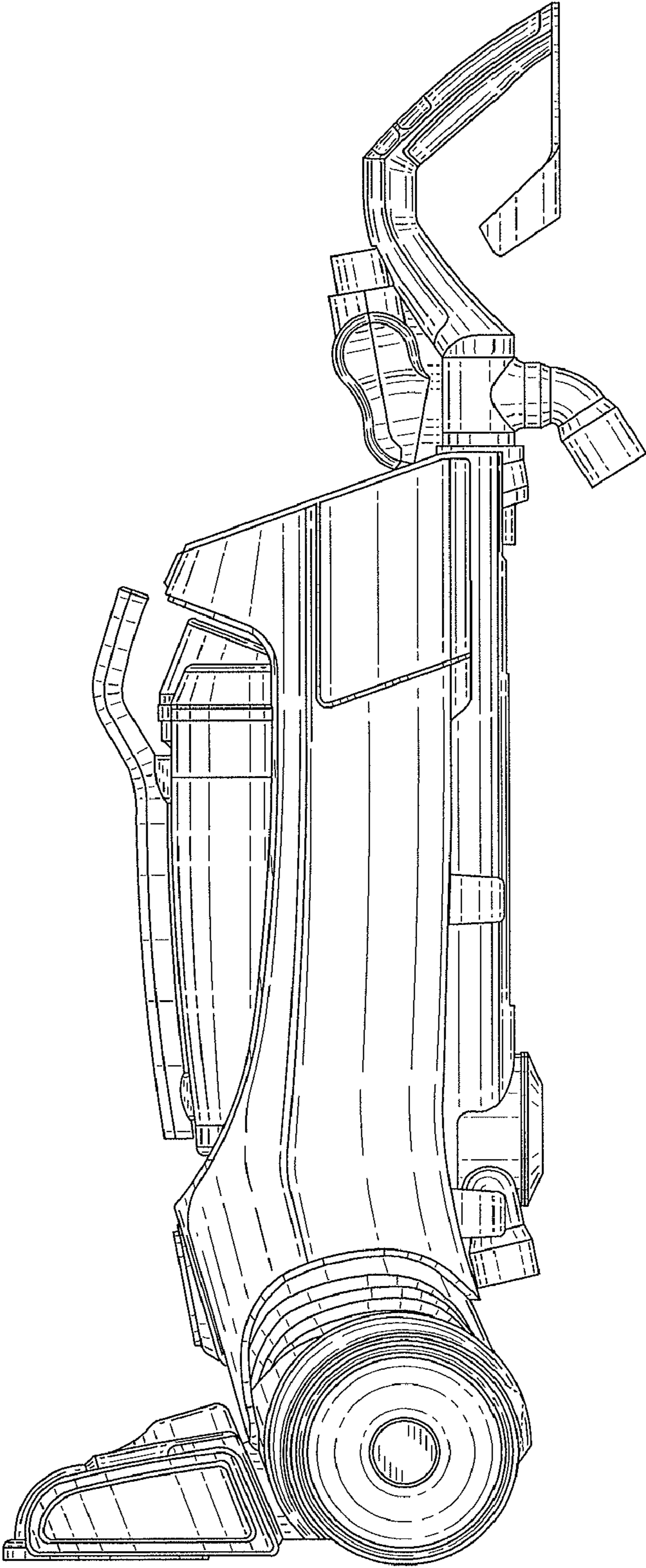

FIG. 4

FIG. 5



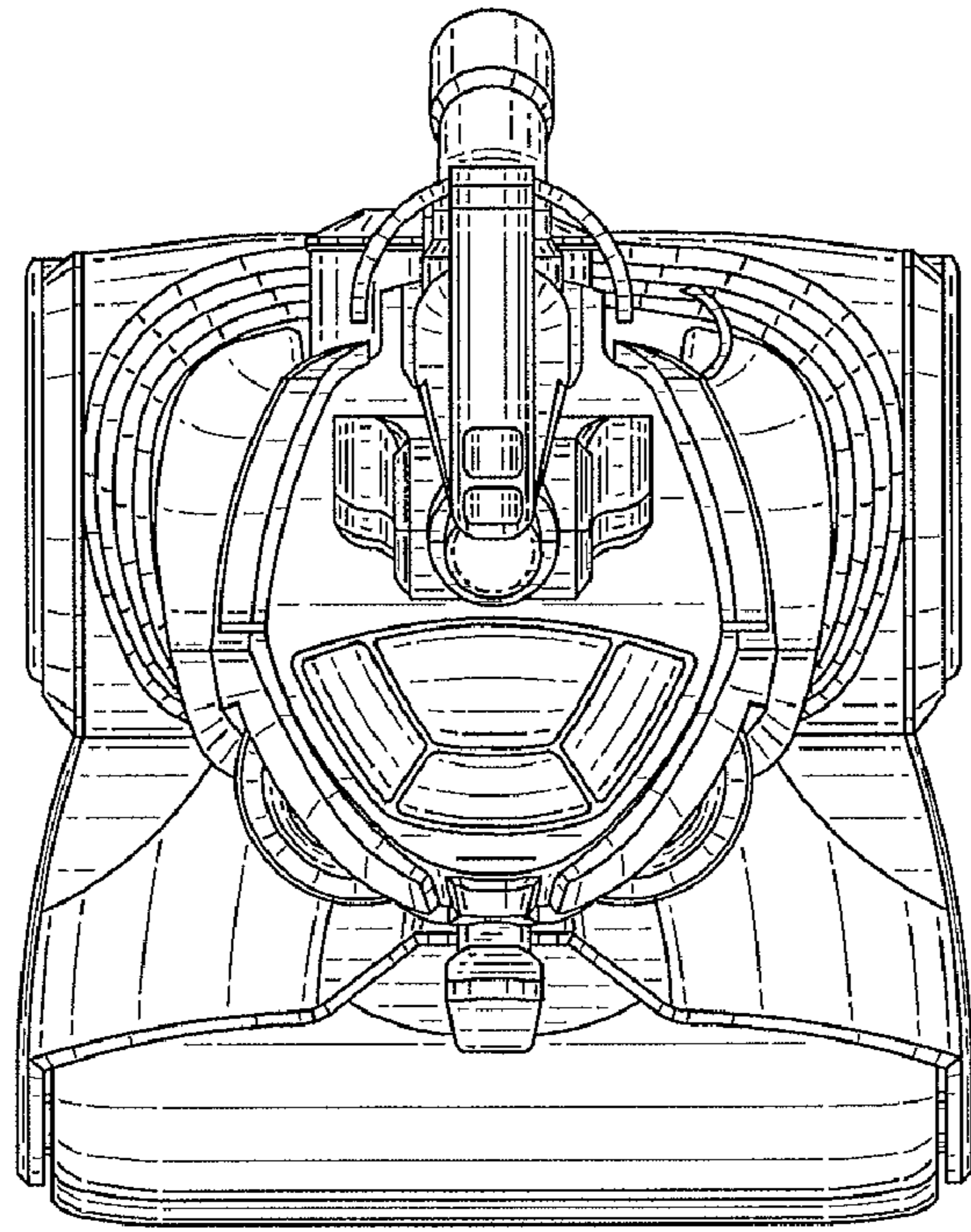

FIG. 6

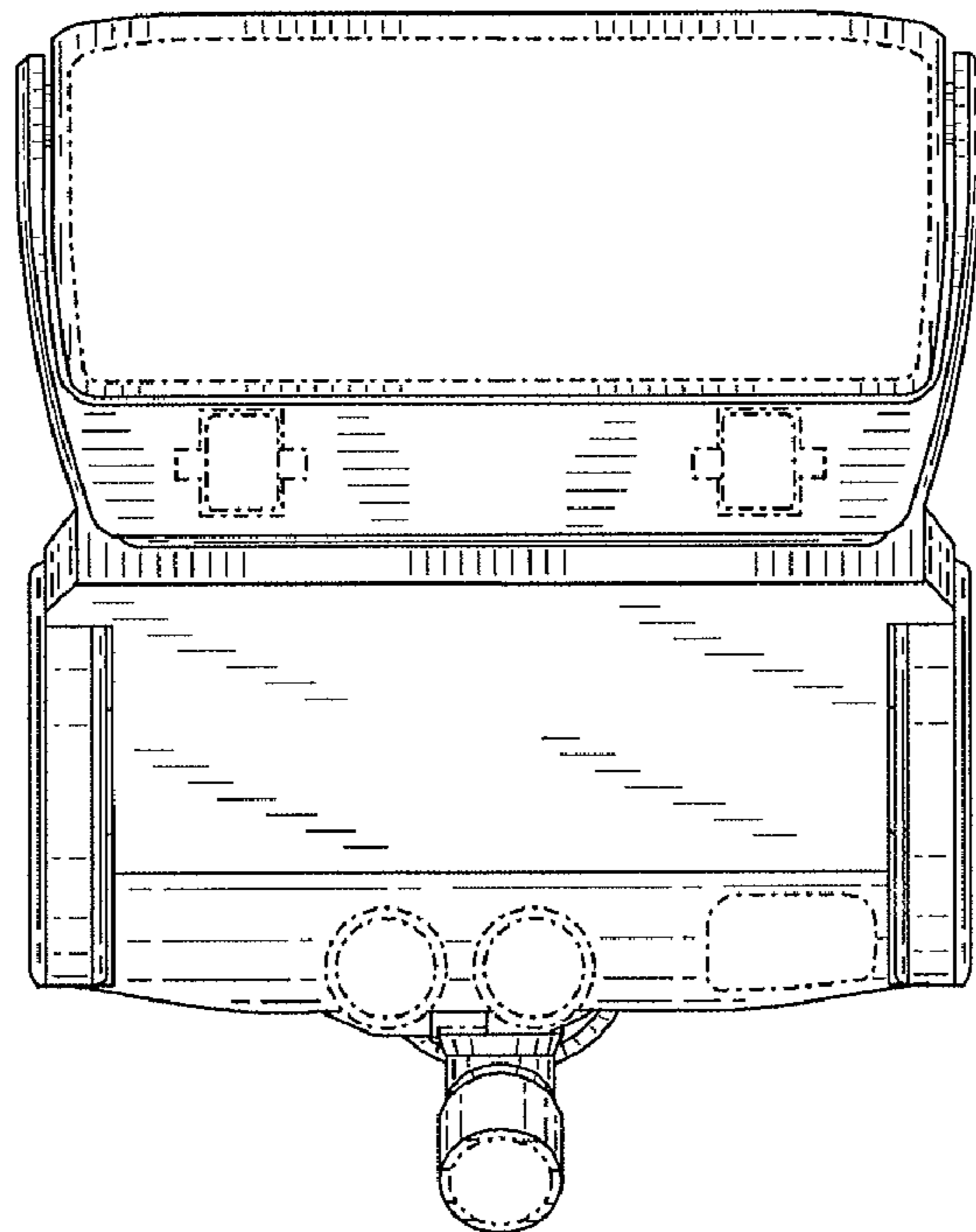

FIG. 7