



US00D662259S

(12) **United States Design Patent**
Vu et al.

(10) **Patent No.:** **US D662,259 S**
(45) **Date of Patent:** **** Jun. 19, 2012**

(54) **NAIL PRODUCT CURING LAMP**
(75) Inventors: **Thong Vu**, Vista, CA (US); **David Valia**,
San Diego, CA (US)
(73) Assignee: **Creative Nail Design, Inc.**, Vista, CA
(US)
(**) Term: **14 Years**

7,118,589 B2 10/2006 Vlahos
D532,931 S * 11/2006 Chang D28/54.1
7,712,473 B1 * 5/2010 Robinson et al. 132/73
D641,105 S * 7/2011 Chan D28/58
7,980,252 B2 * 7/2011 Yue 132/73.5
D643,576 S * 8/2011 Chan D28/58
2006/0260628 A1 * 11/2006 Chan 132/73
2009/0160923 A1 6/2009 Custer
2010/0293805 A1 * 11/2010 Chang 34/202
2011/0277338 A1 * 11/2011 Li et al. 34/275

(21) Appl. No.: **29/383,960**
(22) Filed: **Jan. 25, 2011**
(51) **LOC (9) Cl.** **28-03**
(52) **U.S. Cl.** **D28/58; D28/54.1**
(58) **Field of Classification Search** D28/54.1,
D28/56-58; 132/73.5, 73; 34/275, 202,
34/90; 250/504 R, 455.11, 492.1
See application file for complete search history.

OTHER PUBLICATIONS

“Light Elegance 100 Volt 9-Watt Easy Cure Lamp” www.lightel-
legance.com [Brochure] (2007).
Photographs of Creative Nail Design Brisa Lamp (2009).
Photographs of Light Elegance Lamp (2007).

* cited by examiner

Primary Examiner — Jennifer Rivard
(74) *Attorney, Agent, or Firm* — Pillsbury Winthrop Shaw
Pittman LLP

(56) **References Cited**

U.S. PATENT DOCUMENTS

2,262,274 A 7/1939 Fingerlin
2,349,509 A 4/1944 Marano
3,287,824 A * 11/1966 Selditz 34/202
4,612,444 A * 9/1986 Ragusa 250/492.1
4,754,769 A * 7/1988 Flynn 132/73.5
D310,724 S * 9/1990 Jackson D28/54.1
4,979,523 A * 12/1990 Grimm 132/73.5
4,988,883 A 1/1991 Oppawsky
5,130,551 A * 7/1992 Nafziger et al. 250/492.1
5,130,553 A 7/1992 Amoh
5,249,367 A * 10/1993 Nafziger et al. 34/275
D381,464 S * 7/1997 Schaeffer et al. D28/54.1
D431,682 S * 10/2000 Seo D28/54.1
D450,389 S * 11/2001 Chang D24/210
D453,858 S * 2/2002 Tsai D28/54.1
6,518,583 B1 * 2/2003 Hennig 250/504 R
D472,348 S * 3/2003 Kurz et al. D28/54.1
6,708,697 B1 * 3/2004 Ziff 132/73
6,762,425 B1 * 7/2004 Strait 250/504 R

(57) **CLAIM**

The ornamental design for a nail product curing lamp, as
shown and described.

DESCRIPTION

FIG. 1 is a front perspective view of an embodiment of the nail
product curing lamp;
FIG. 2 is a front view thereof;
FIG. 3 is a rear view thereof;
FIG. 4 is a left side view thereof, the right side view thereof
being a mirror image thereof;
FIG. 5 is a top view thereof; and,
FIG. 6 is a bottom view thereof.
Where included, dotted lines are provided for context only,
and form no part of the claimed design.

1 Claim, 5 Drawing Sheets

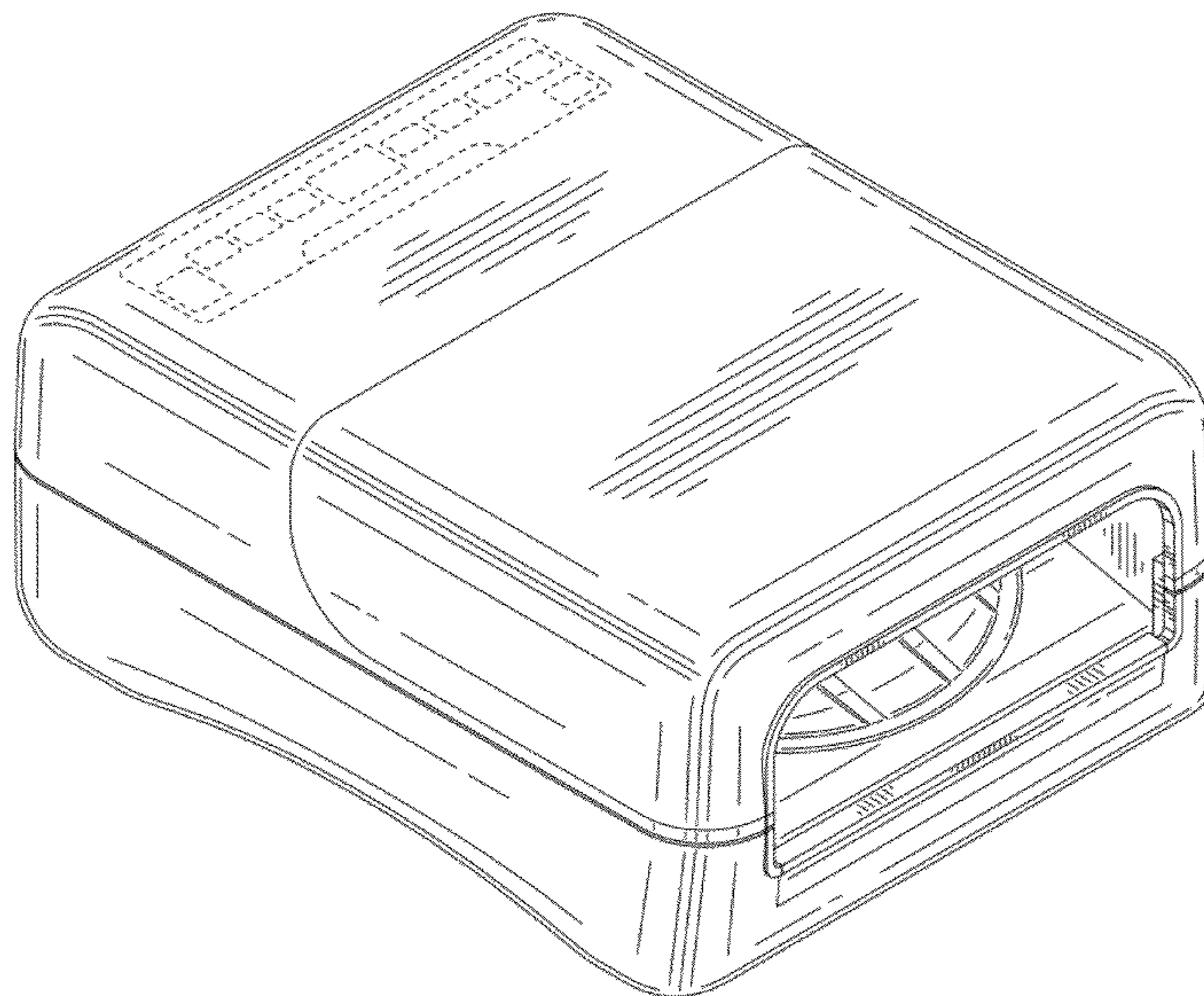

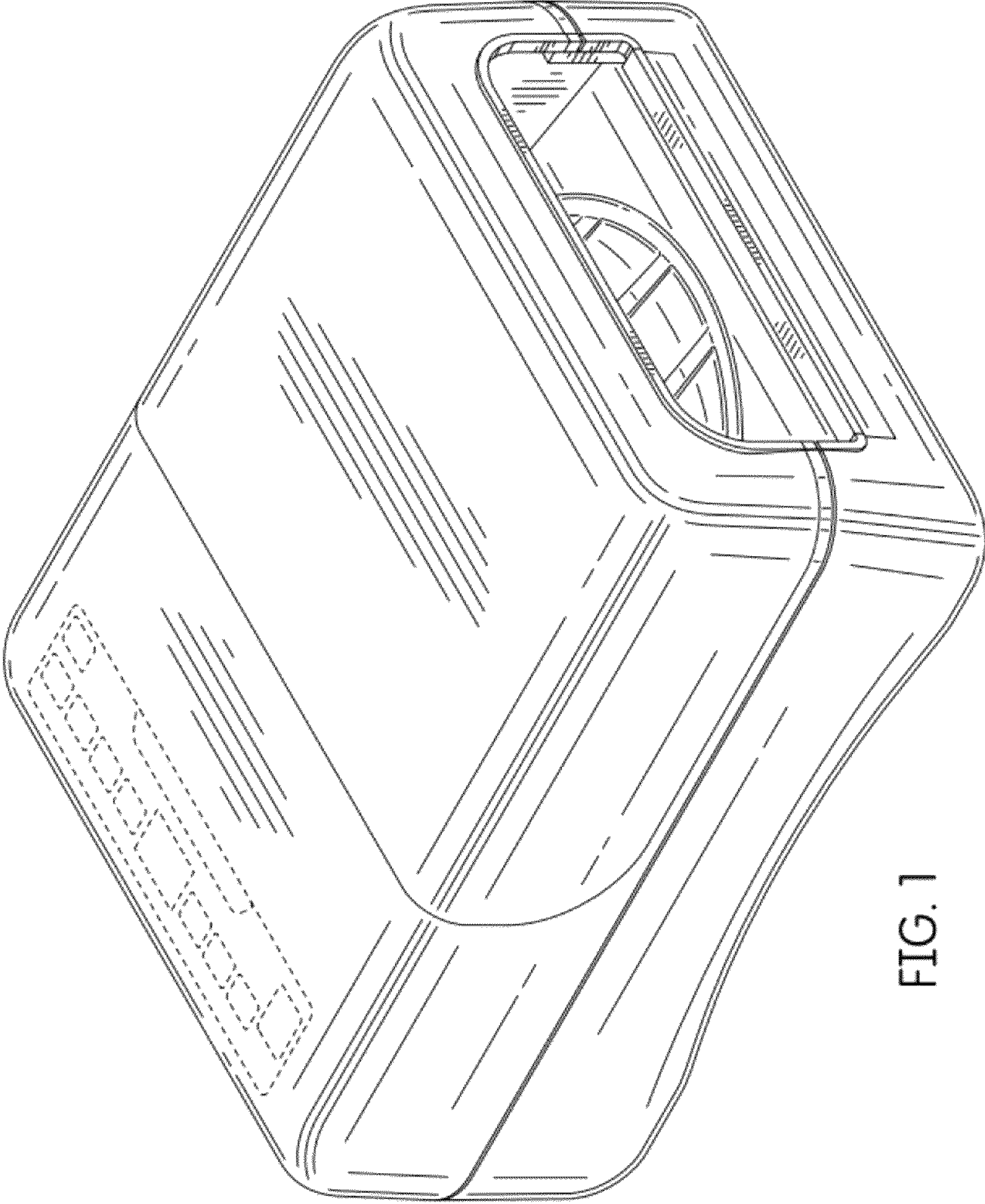

FIG. 1

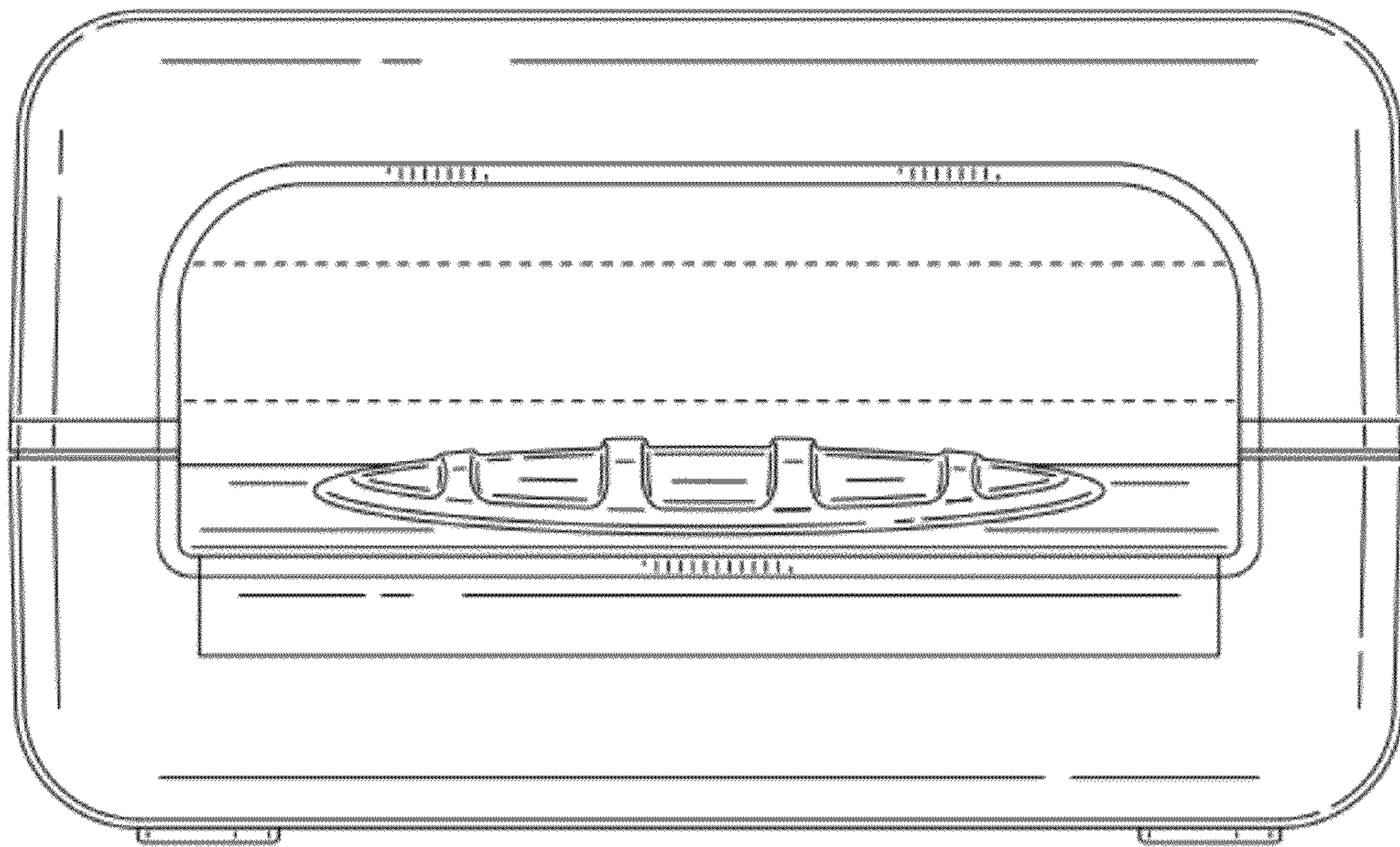

FIG. 2

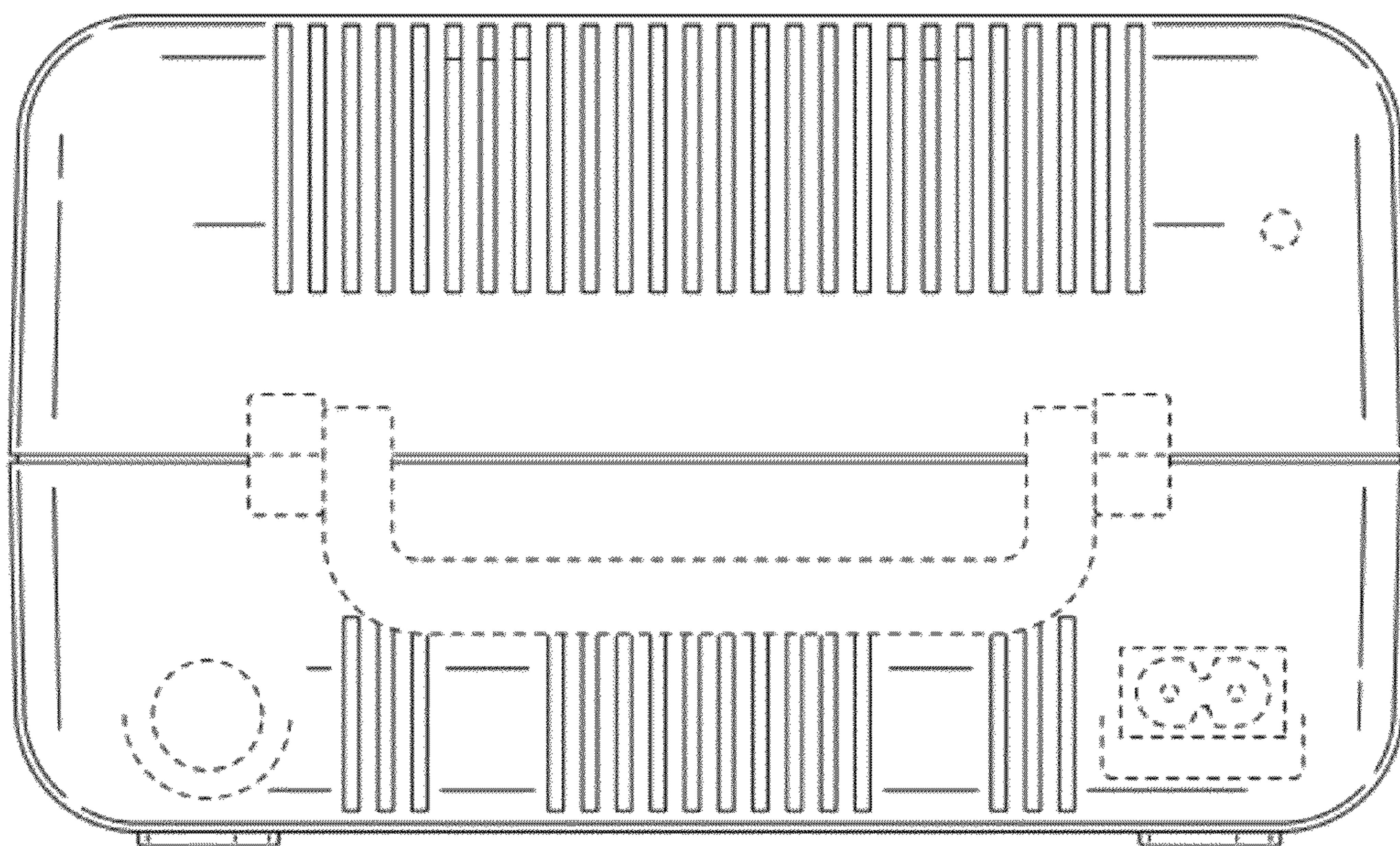

FIG. 3

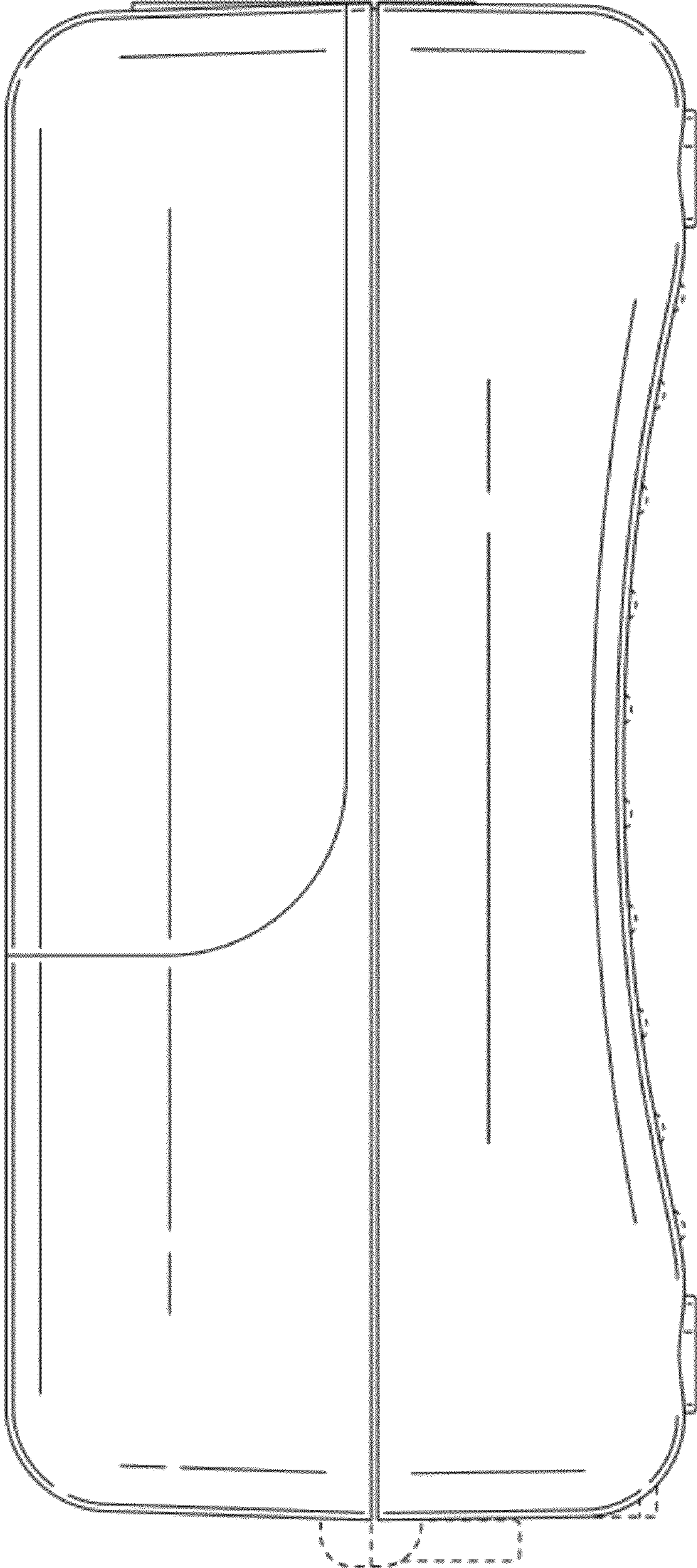

FIG. 4

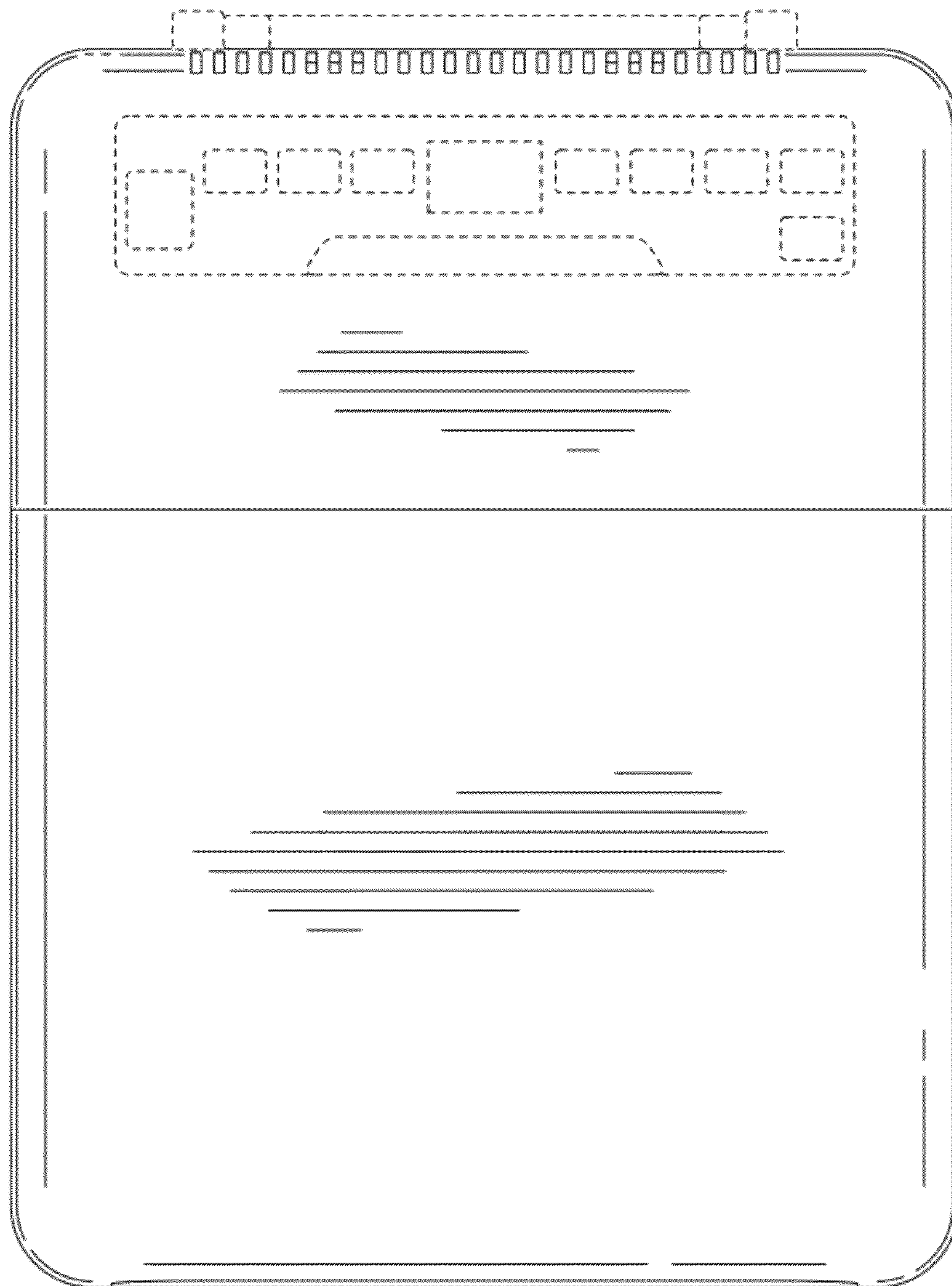

FIG. 5

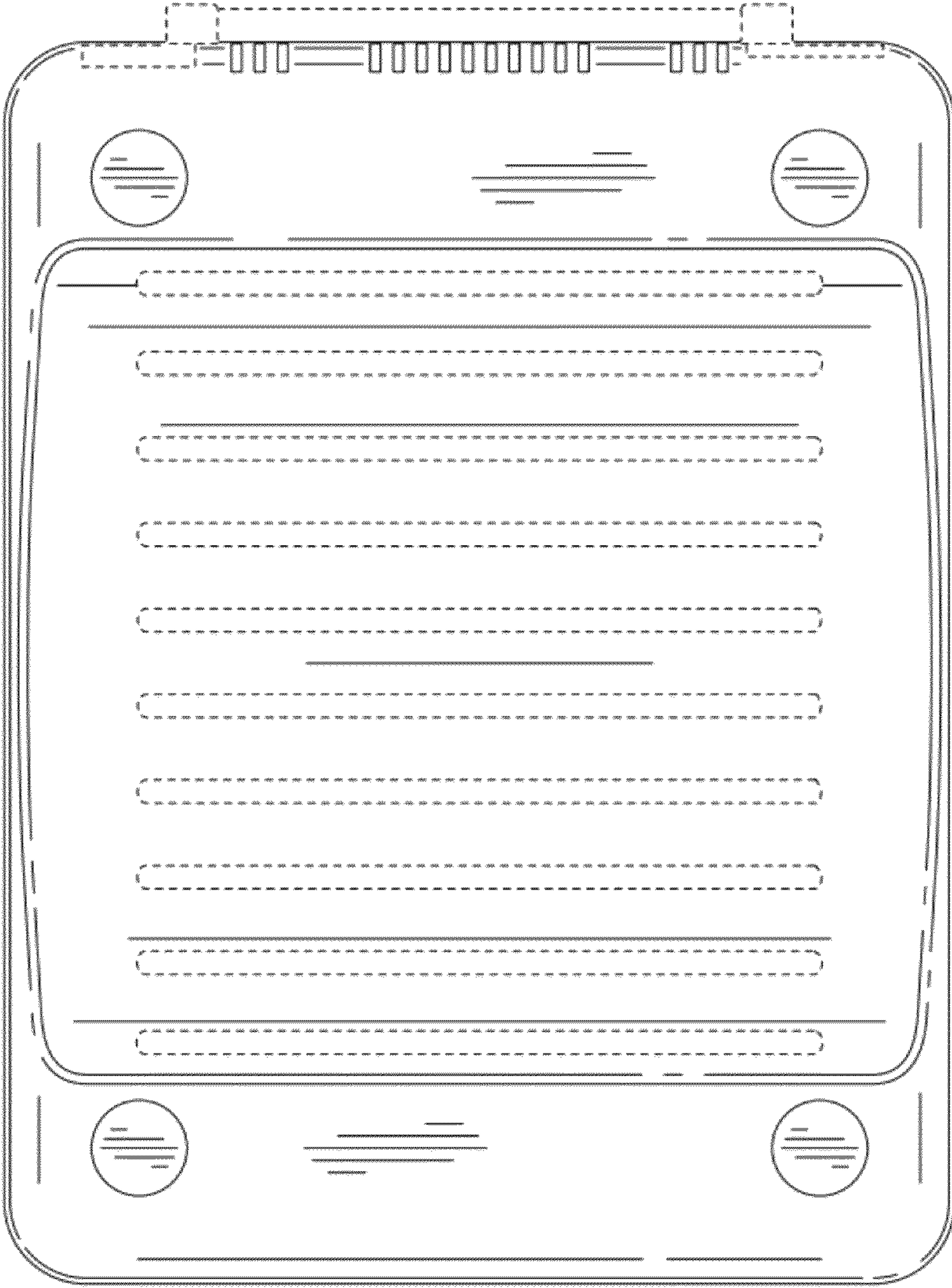

FIG. 6