



US00D662174S

(12) **United States Design Patent**
Reijnders

(10) **Patent No.:** **US D662,174 S**

(45) **Date of Patent:** **** Jun. 19, 2012**

(54) **DISPENSER**

(75) **Inventor:** **Waldo Wouter Reijnders**, Amsterdam
(NL)

(73) **Assignee:** **Reckitt Benckiser LLC**, Parsippany, NJ
(US)

(**) **Term:** **14 Years**

(21) **Appl. No.:** **29/380,393**

(22) **Filed:** **Dec. 3, 2010**

(30) **Foreign Application Priority Data**

Jun. 7, 2010 (EM) 001716143-0001

(51) **LOC (9) Cl.** **23-01**

(52) **U.S. Cl.** **D23/208**

(58) **Field of Classification Search** D23/208;
4/223, 225.1, 227.1, 229-231
See application file for complete search history.

(56) **References Cited**

U.S. PATENT DOCUMENTS

D508,106 S * 8/2005 Nguyen et al. D23/208
D547,418 S * 7/2007 King et al. D23/208
D548,304 S * 8/2007 King et al. D23/208

D548,305 S * 8/2007 King et al. D23/208
D558,854 S * 1/2008 Burt D23/208
D558,855 S * 1/2008 Arora et al. D23/208
D573,687 S * 7/2008 Hill D23/208
D591,824 S * 5/2009 Leonard et al. D23/208
D613,368 S * 4/2010 Padain et al. D23/208
7,832,025 B2 * 11/2010 Virica et al. 4/227.4

* cited by examiner

Primary Examiner — Robin V Webster

(74) *Attorney, Agent, or Firm* — Norris McLaughlin & Marcus PA

(57) **CLAIM**

The ornamental design for a dispenser, as shown and described.

DESCRIPTION

FIG. 1 is a front perspective view of my dispenser;
FIG. 2 is a front elevational view thereof;
FIG. 3 is a rear elevational view thereof;
FIG. 4 is a left side elevational view thereof;
FIG. 5 is a right side elevational view thereof;
FIG. 6 is a top plan view thereof; and,
FIG. 7 is a bottom plan view thereof.

1 Claim, 6 Drawing Sheets

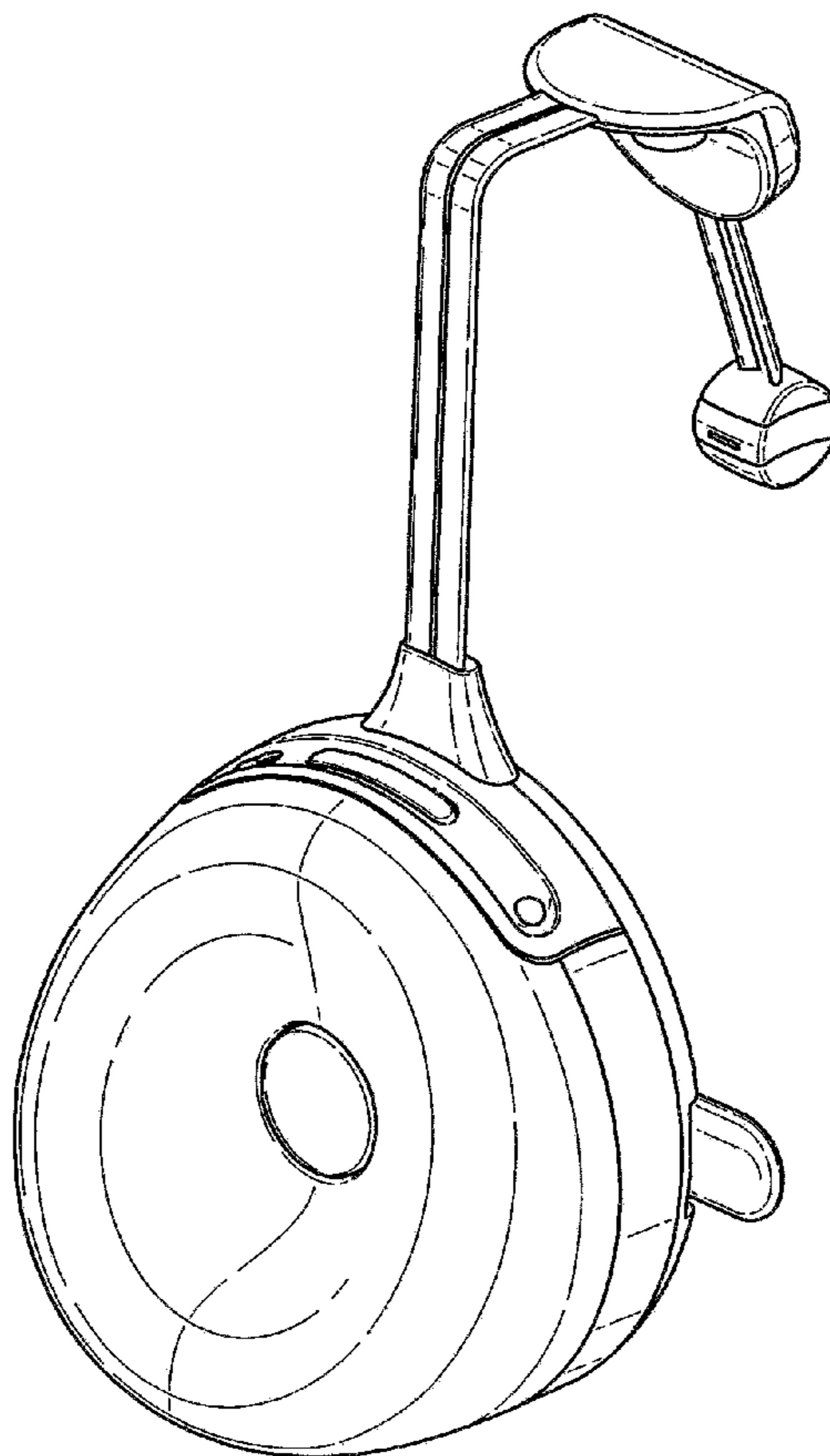

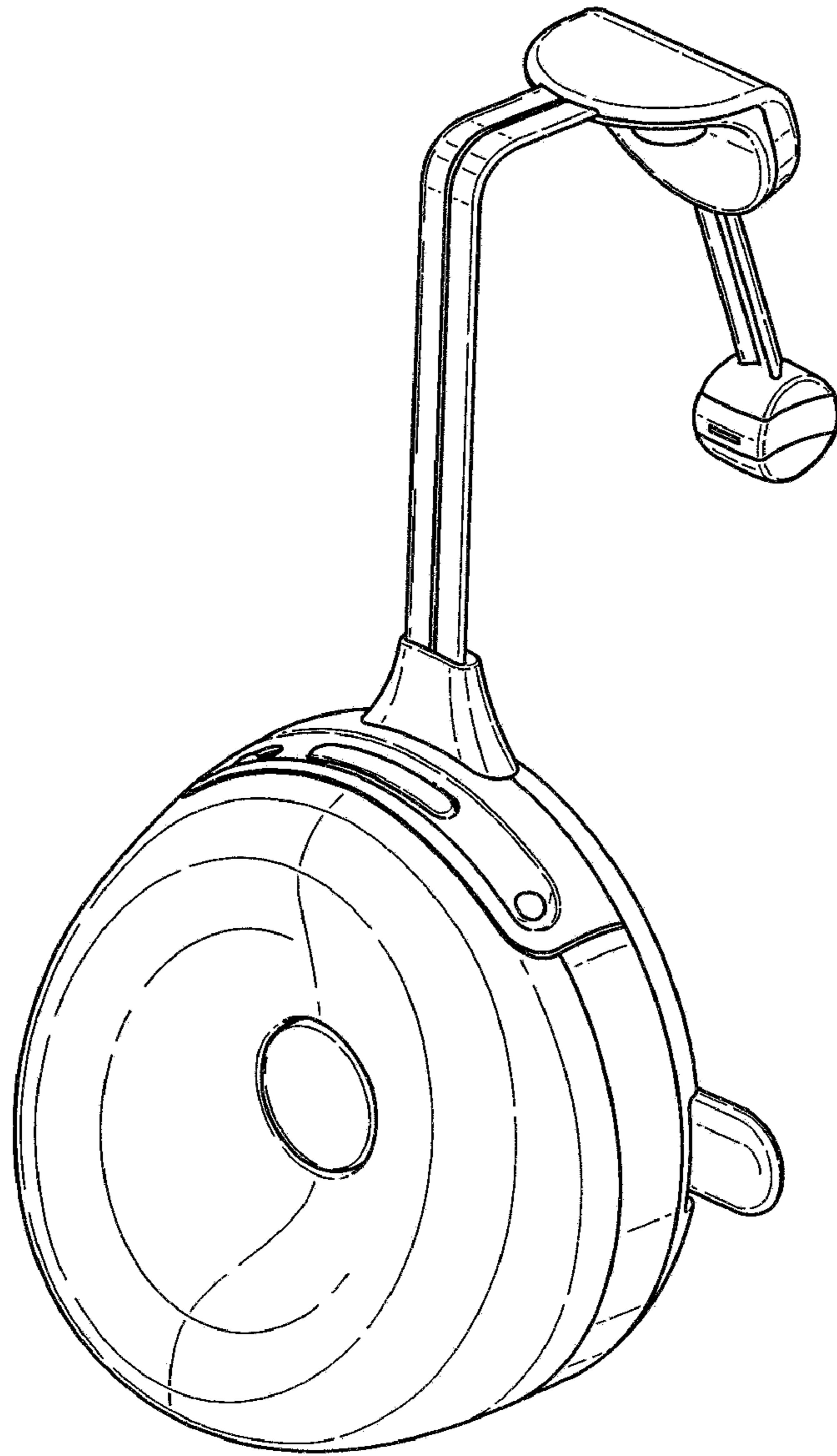

Fig. 1.

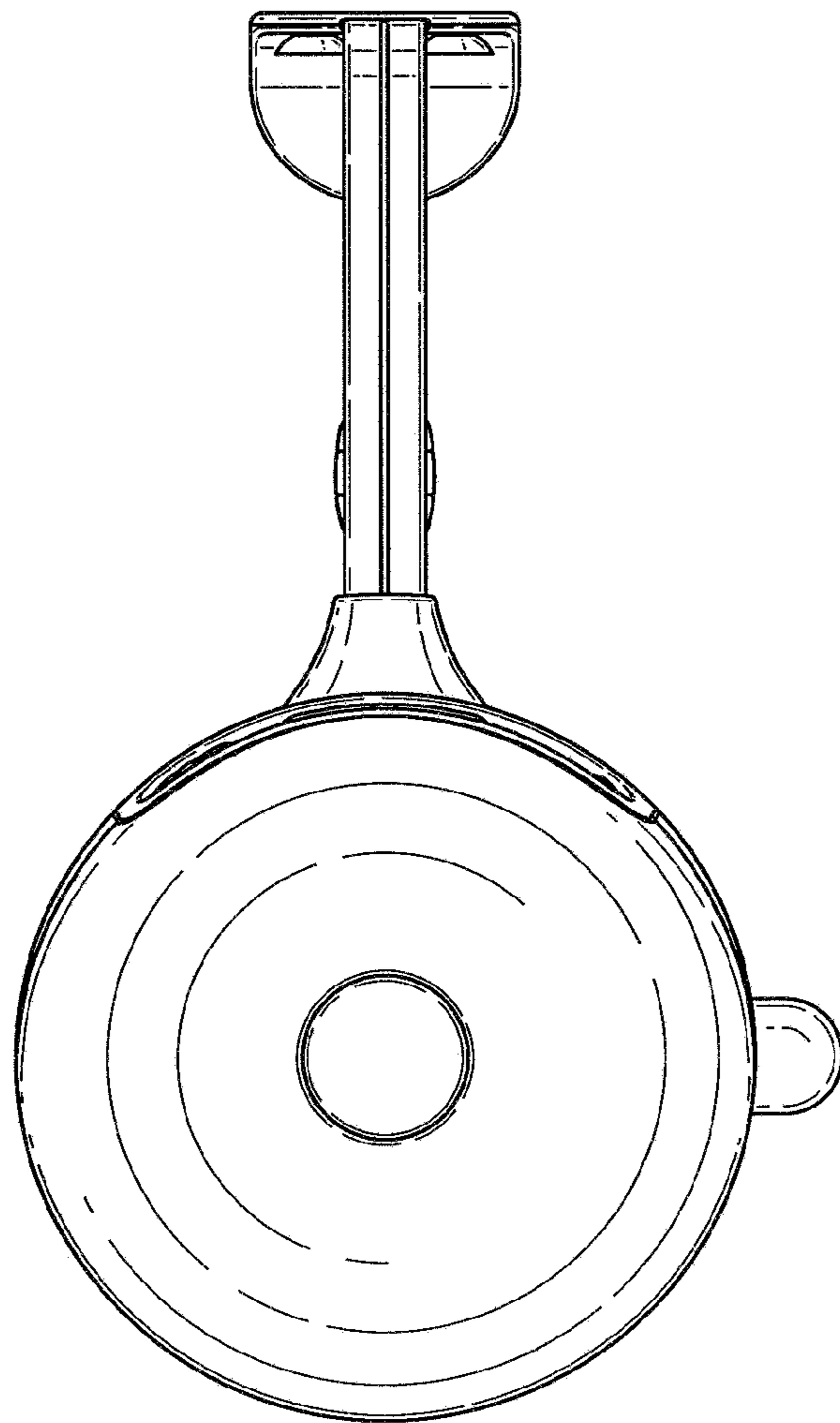

Fig.2.

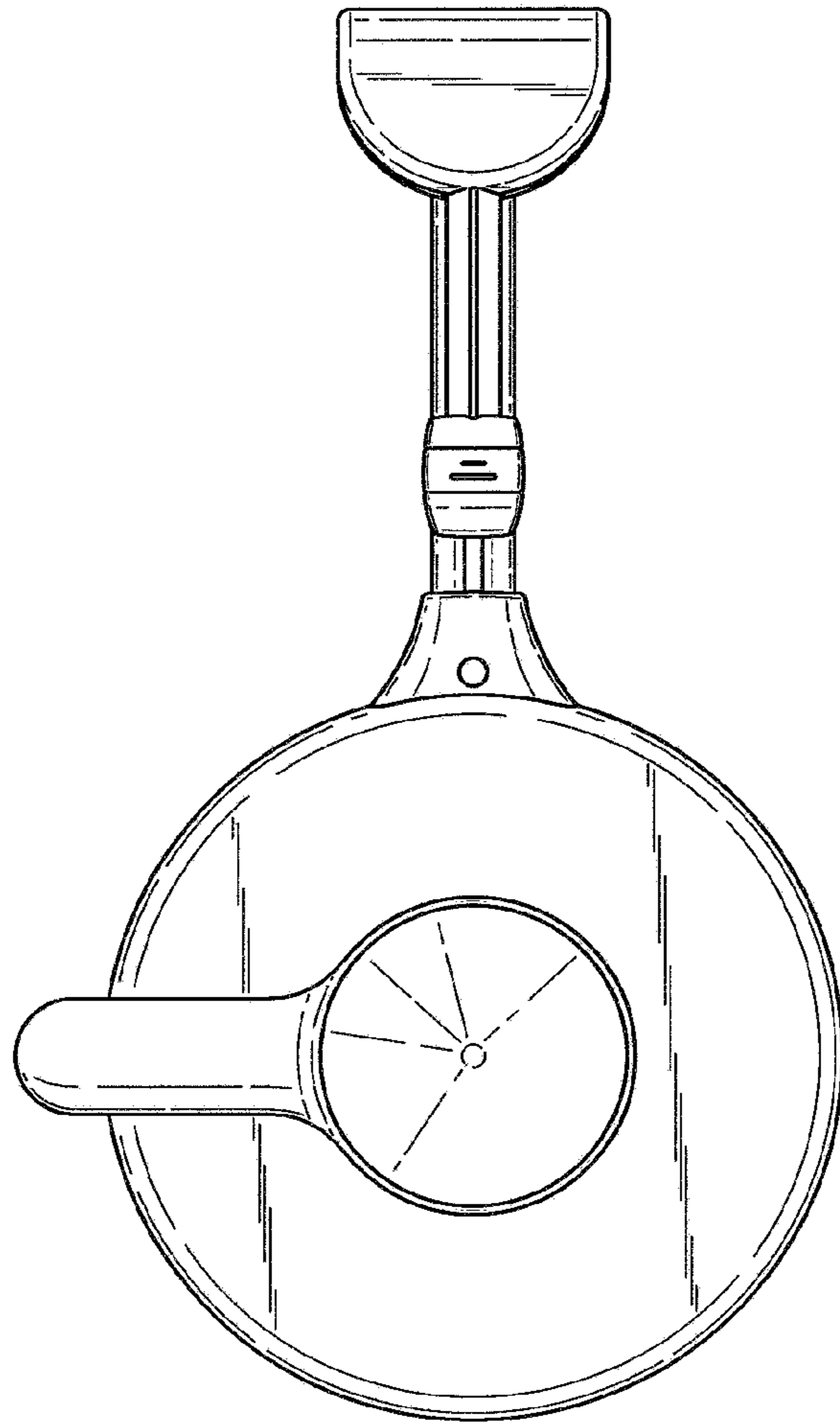

Fig.3.

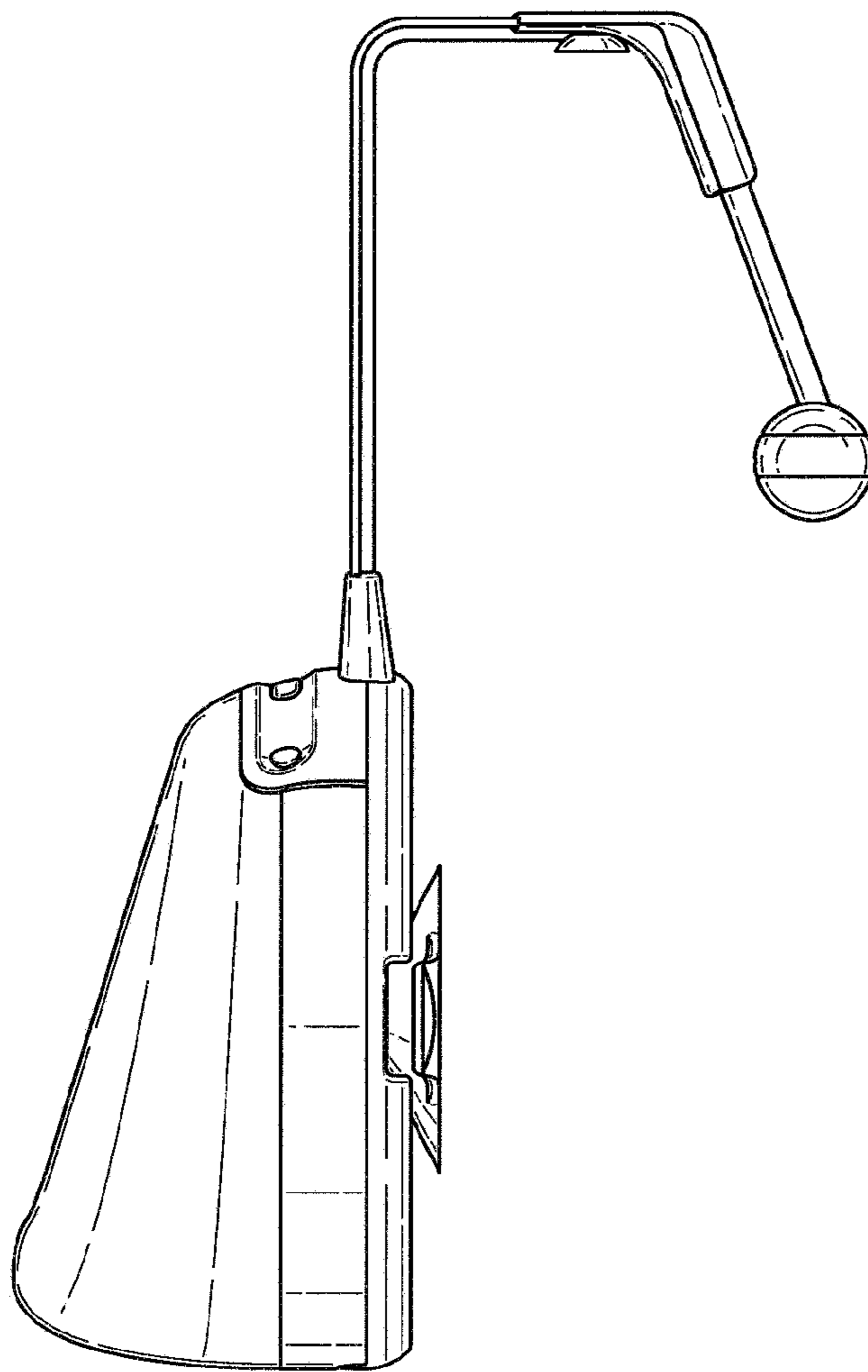

Fig.4.

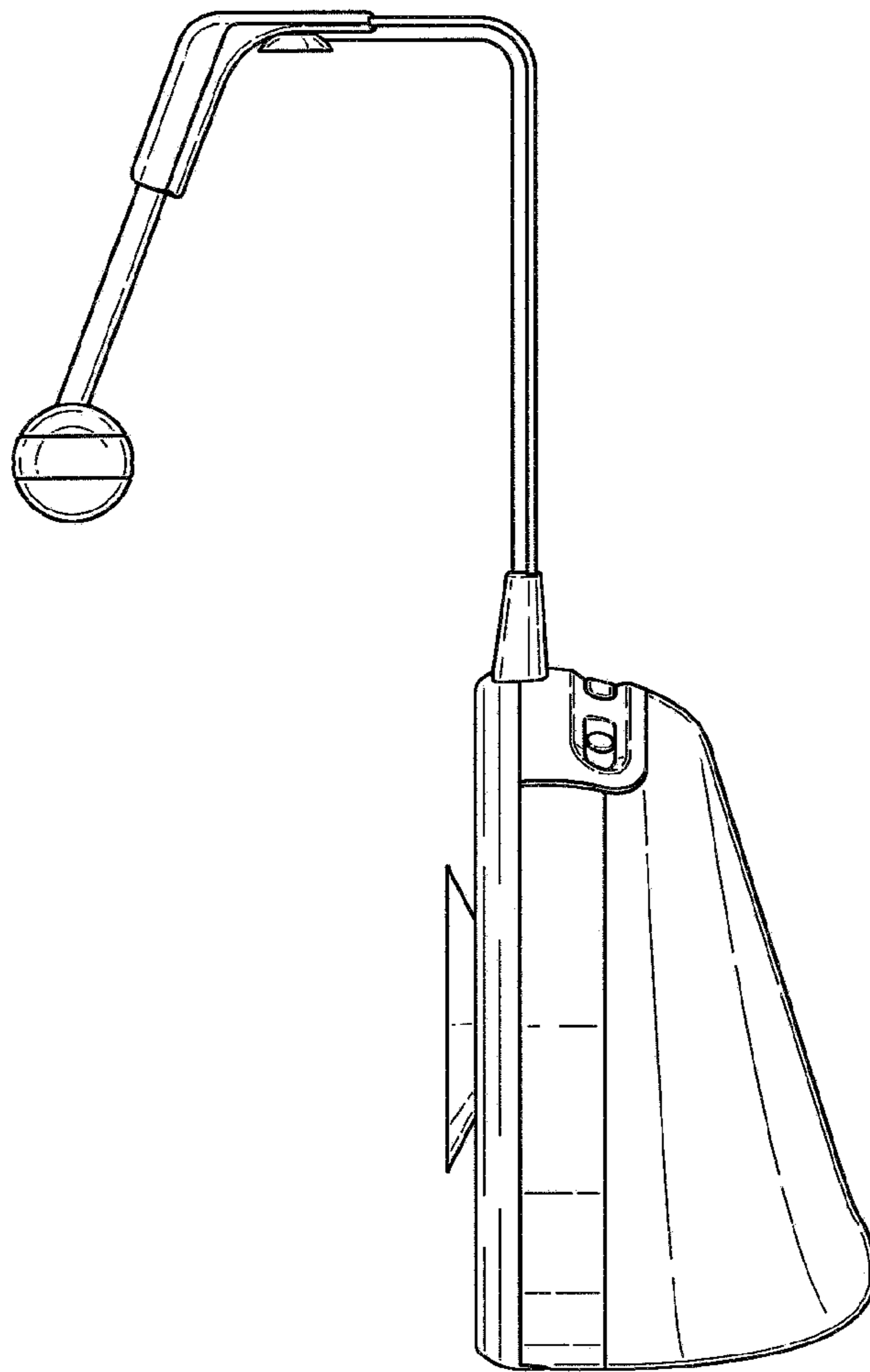

Fig.5.

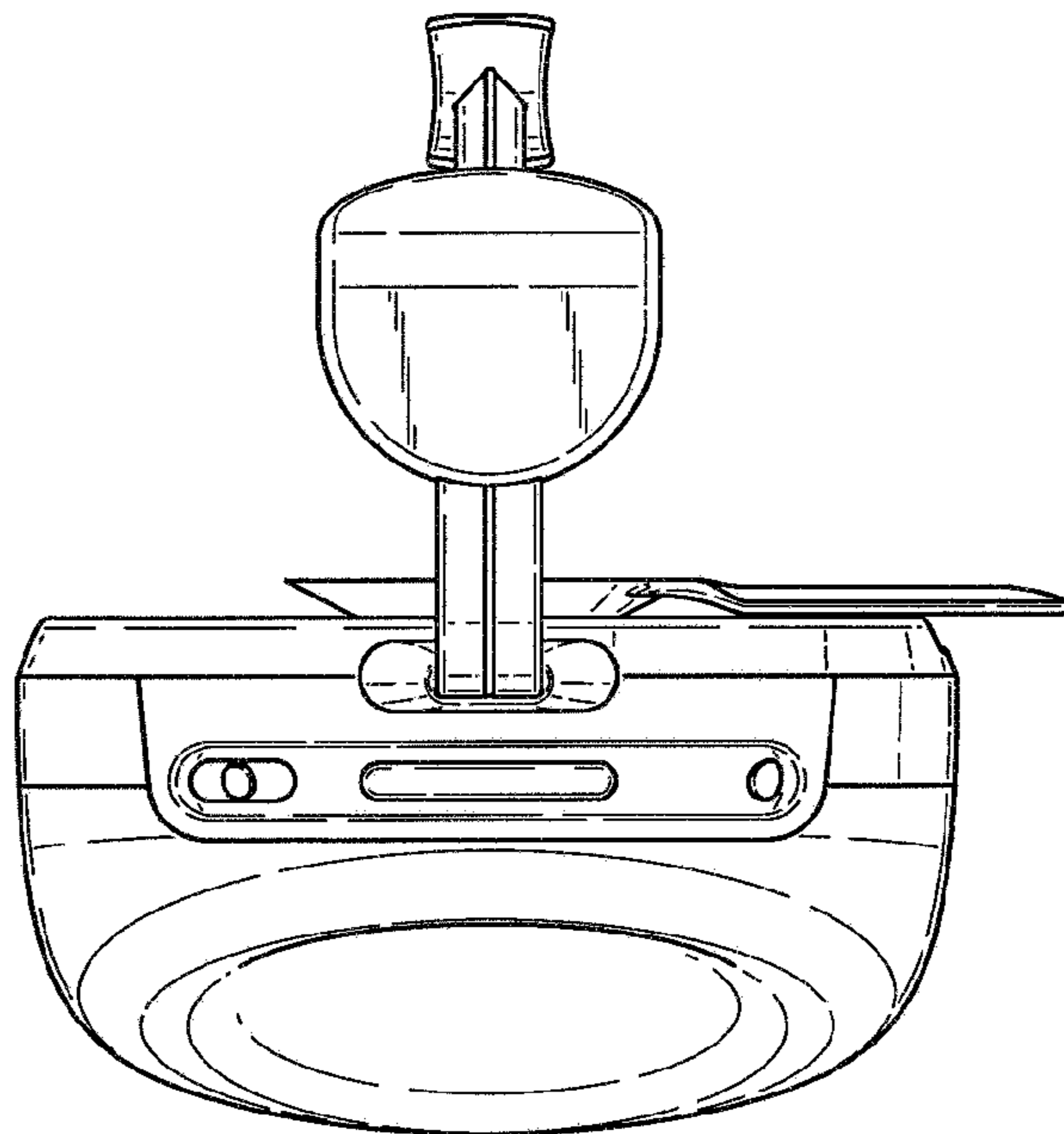

Fig.6.

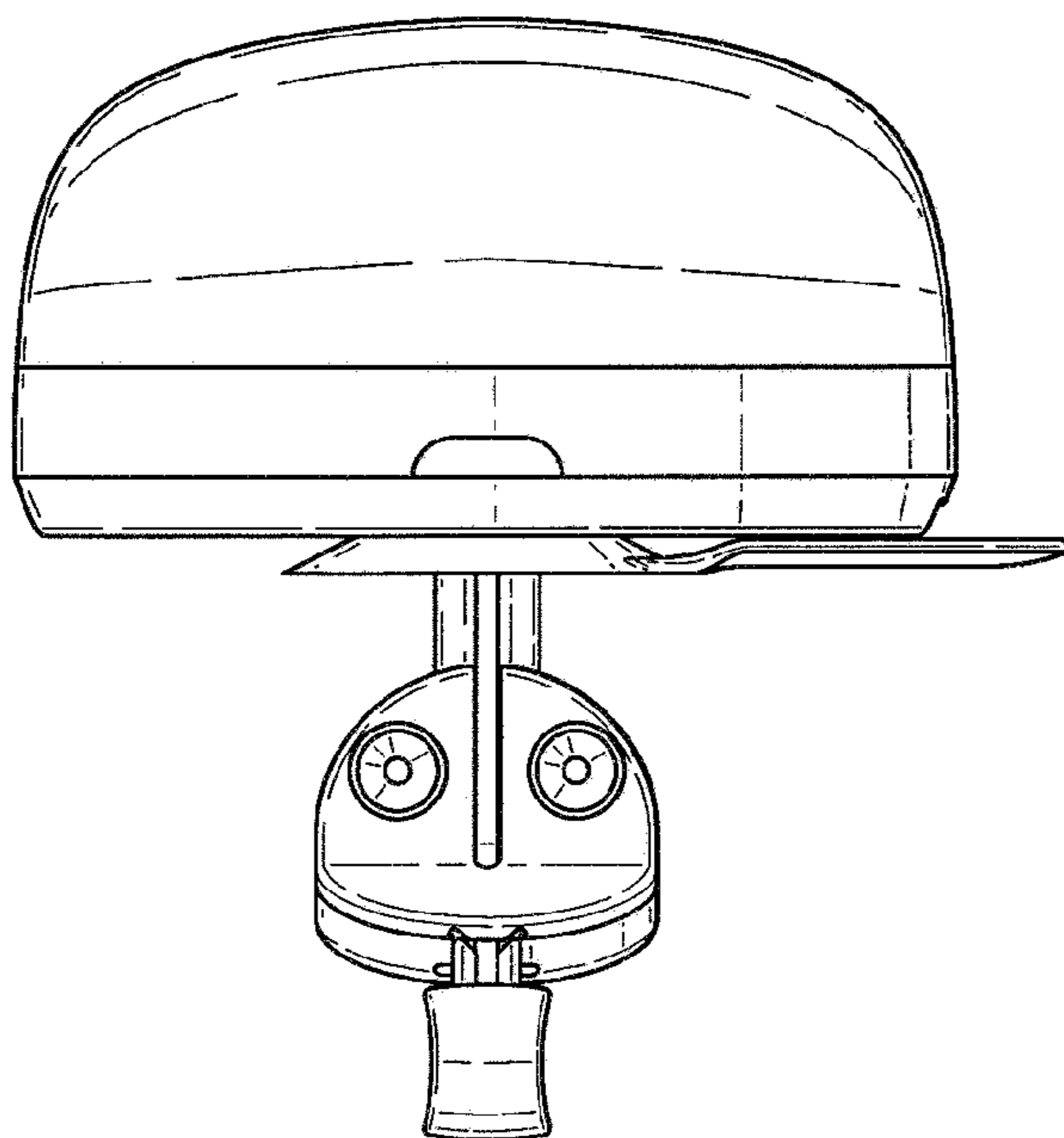

Fig.7.