



US00D661960S

(12) **United States Design Patent**
Padula

(10) **Patent No.:** **US D661,960 S**
(45) **Date of Patent:** **** Jun. 19, 2012**

(54) **DENT PULLER**

(75) Inventor: **Philip Padula**, Farmington Hills, MI
(US)

(73) Assignee: **Philip Padula**, Farmington Hills, MI
(US)

(**) Term: **14 Years**

(21) Appl. No.: **29/388,027**

(22) Filed: **Mar. 23, 2011**

(51) **LOC (9) Cl.** **08-05**

(52) **U.S. Cl.** **D8/30**

(58) **Field of Classification Search** D8/14,
D8/29.1-29.2, 30, 107; 219/86.21, 86.25,
219/86.8-86.9, 222, 225, 227, 229, 234,
219/238; D30/153; D21/682; 72/447, 451,
72/457-458, 705

See application file for complete search history.

(56) **References Cited**

U.S. PATENT DOCUMENTS

1,911,674	A *	5/1933	Cameron	72/457
D197,549	S *	2/1964	Johnson	D8/64
3,863,342	A *	2/1975	Griffies et al.	30/393
3,922,902	A *	12/1975	Jarman	72/453.1
4,048,471	A *	9/1977	Ours	219/228
D250,630	S *	12/1978	Allegretti	D8/107
D255,767	S *	7/1980	Ettinger	D8/30
4,702,473	A *	10/1987	Paquette	482/74
D299,373	S *	1/1989	Parker et al.	D21/682
D351,264	S *	10/1994	Stout	D30/153

5,440,091	A *	8/1995	Galbraith et al.	219/86.21
5,541,381	A *	7/1996	Galbraith et al.	219/86.21
D374,047	S *	9/1996	Thielemann	D21/682
D443,192	S *	6/2001	Hopf	D8/107
2003/0097869	A1 *	5/2003	Meichtry	72/705

OTHER PUBLICATIONS

Rolson Suction Cup Dent Puller. Downloaded Feb. 12, 2012 at http://www.alibaba.com/product-gs/259090337/Suction_Cup_Dent_Puller_Auto_Tool.html.*

* cited by examiner

Primary Examiner — Philip S Hyder

Assistant Examiner — Roselynn Cody

(74) *Attorney, Agent, or Firm* — Gifford, Krass, Sprinkle, Anderson & Citkowski, P.C.

(57) **CLAIM**

The ornamental design for a dent puller, as shown and described.

DESCRIPTION

FIG. 1 is a front perspective view illustrating the dent puller of the present invention;

FIG. 2 is a top plan view thereof;

FIG. 3 is a right side view thereof, the left side being a mirror image thereof;

FIG. 4 is a bottom view thereof;

FIG. 5 is a rear view thereof; and,

FIG. 6 is a front view thereof.

1 Claim, 1 Drawing Sheet

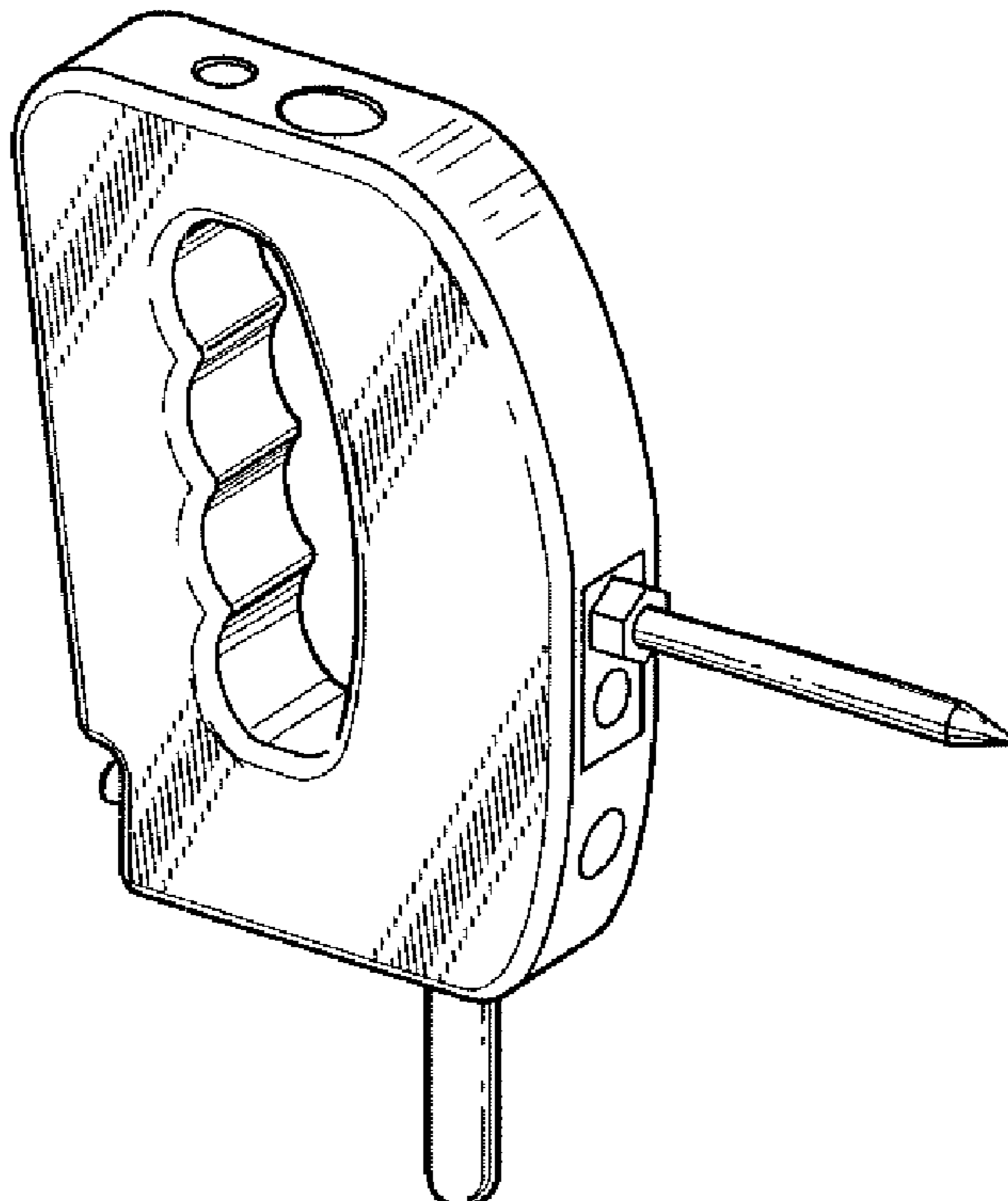

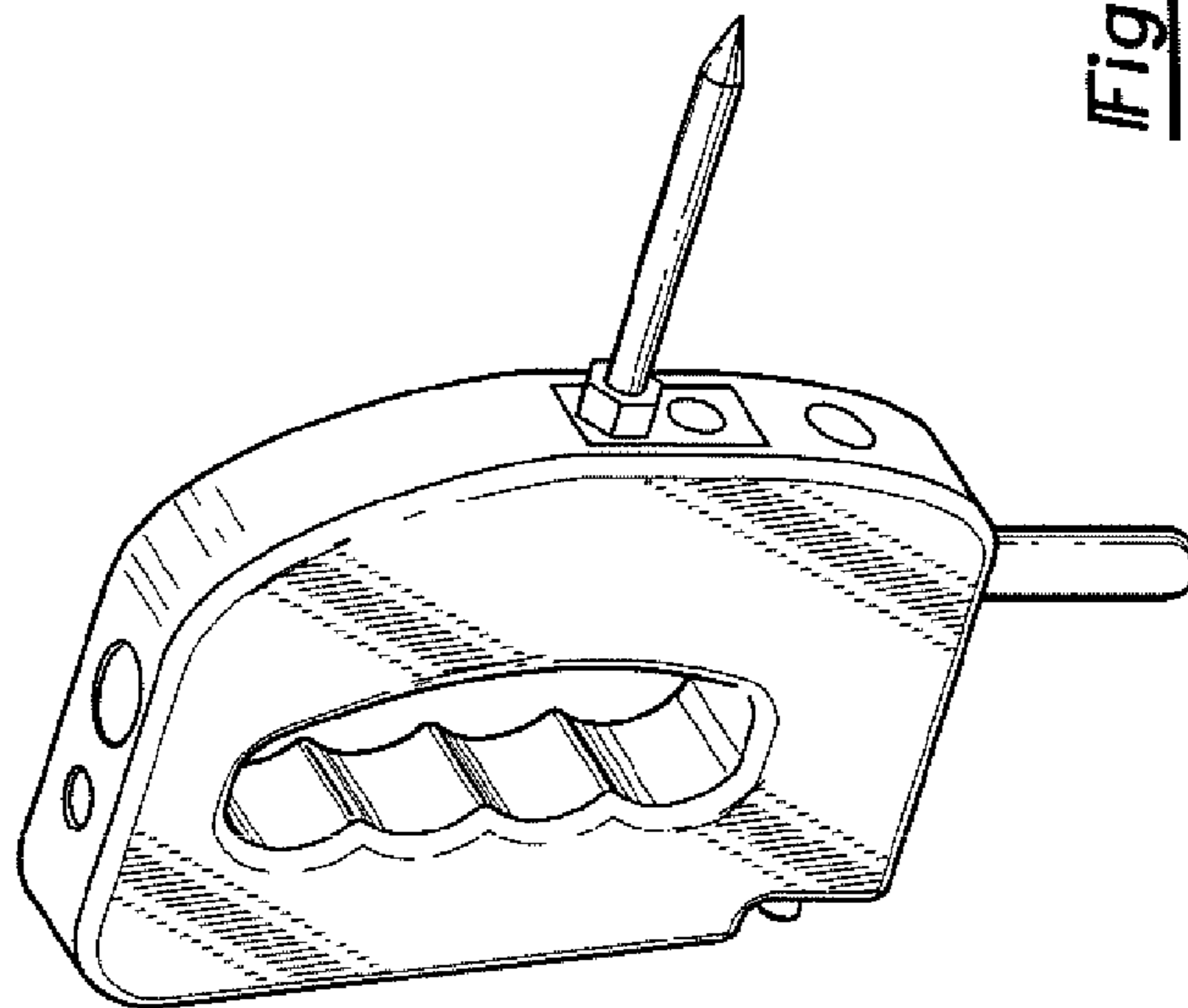

Fig-1

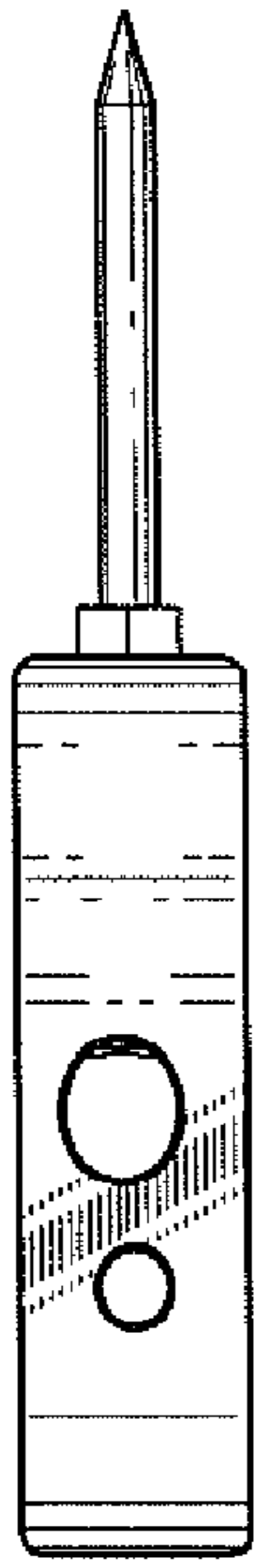

Fig-2

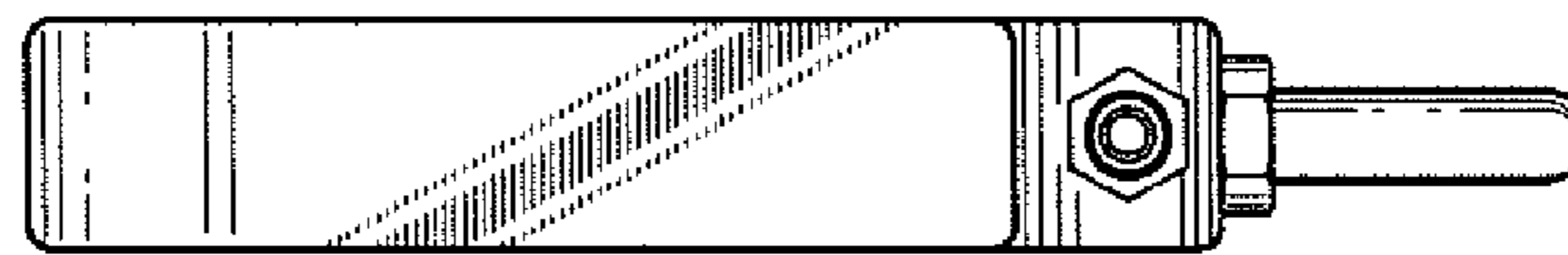

Fig-5

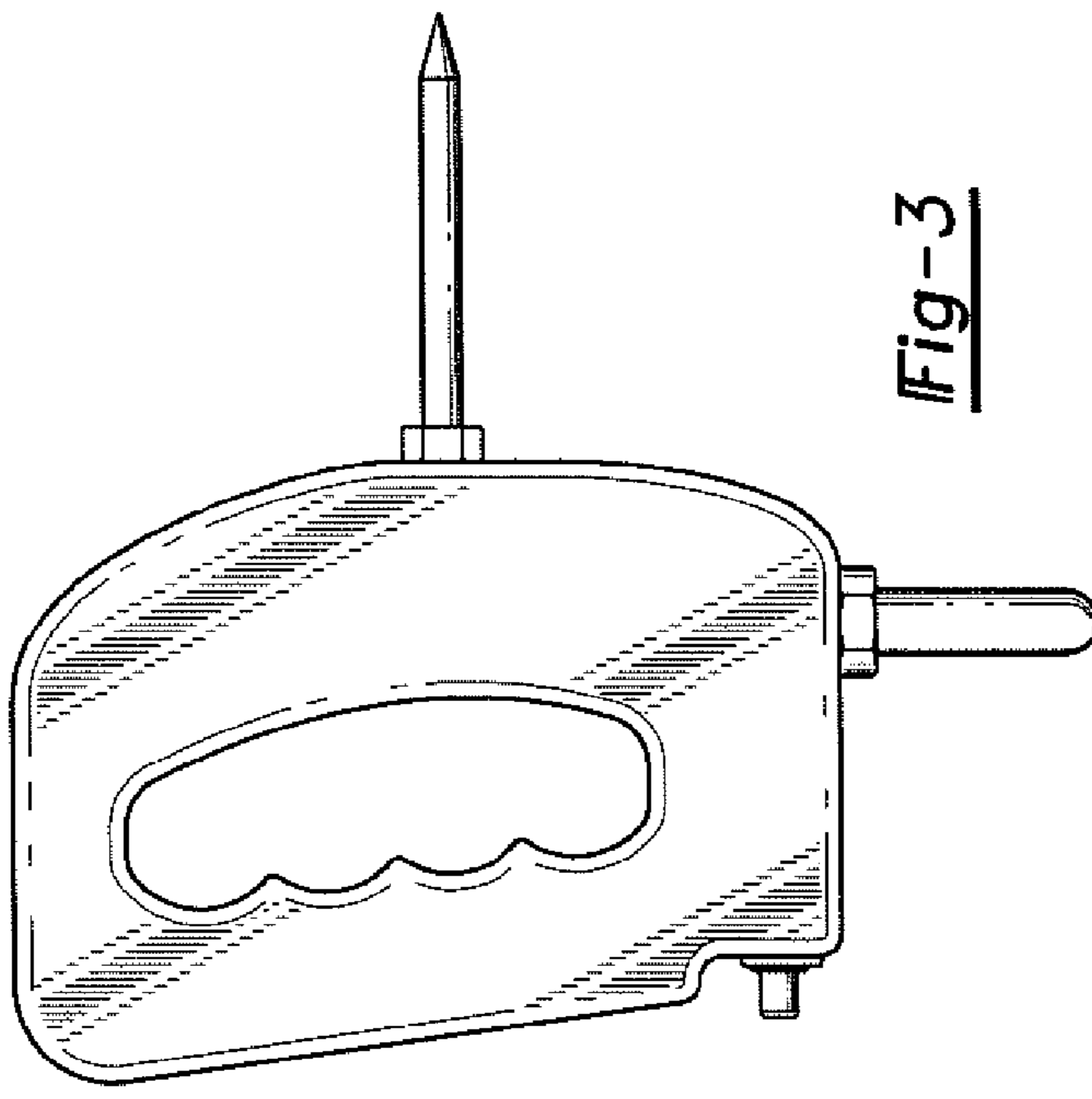

Fig-3

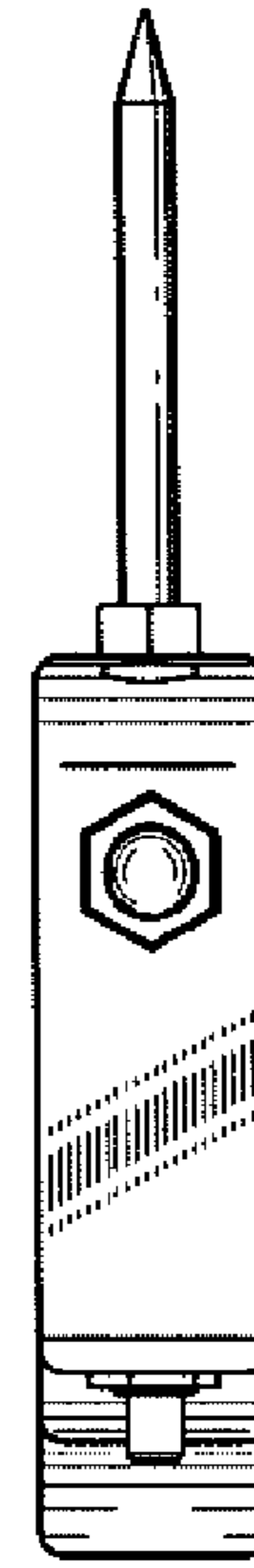

Fig-4

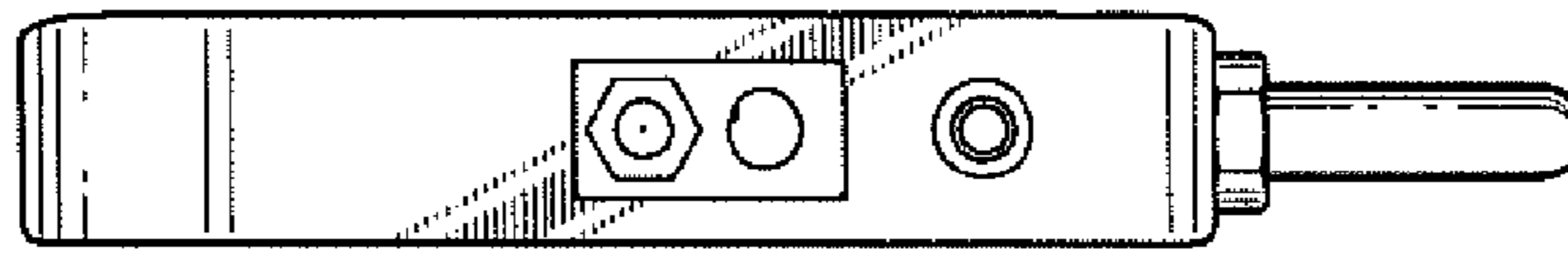

Fig-6