

US00D661942S

(12) **United States Design Patent**
Palermo et al.

(10) **Patent No.:** **US D661,942 S**
(45) **Date of Patent:** **** Jun. 19, 2012**

(54) **TOASTER**

(75) Inventors: **Joseph Palermo**, Boynton Beach, FL
(US); **Scott Henderson**, Brooklyn, NY
(US); **Augusto Picozza**, Boca Raton, FL
(US)

(73) Assignee: **Sunbeam Products, Inc.**, Boca Raton,
FL (US)

(**) Term: **14 Years**

(21) Appl. No.: **29/412,819**

(22) Filed: **Feb. 8, 2012**

(51) **LOC (9) Cl.** **07-02**

(52) **U.S. Cl.** **D7/330**

(58) **Field of Classification Search** D7/323,
D7/328-334, 340-341, 346, 350.4, 354-365,
D7/367, 390, 402, 405-411; 99/326-327,
99/329 R, 331-332, 341, 349, 357, 375, 385-389,
99/392, 400, 423; 219/385-392, 405, 443.1,
219/450.1, 489, 492, 532; 426/233, 523
See application file for complete search history.

(56) **References Cited**

U.S. PATENT DOCUMENTS

D124,059 S * 12/1940 Christenson, Jr. et al. D7/330
2,309,640 A * 1/1943 Gough 99/327

D156,153 S * 11/1949 Olson et al. D7/330
2,611,849 A * 9/1952 Gough 219/489
D185,076 S * 5/1959 Ernest D7/330
D422,833 S * 4/2000 Cruz et al. D7/330
D470,355 S * 2/2003 Xie et al. D7/330
D470,709 S * 2/2003 Starr et al. D7/330
D488,664 S * 4/2004 Seum et al. D7/330
D557,061 S * 12/2007 Genslak et al. D7/330
D615,343 S * 5/2010 Bock et al. D7/330
D635,390 S * 4/2011 Duncan et al. D7/330
D640,894 S * 7/2011 Duncan et al. D7/330

* cited by examiner

Primary Examiner — Ricky Pham

(74) *Attorney, Agent, or Firm* — Michael J. Corrigan

(57) **CLAIM**

The ornamental design for the toaster, as shown and described.

DESCRIPTION

FIG. 1 is a top front perspective view of the toaster;
FIG. 2 is a front view thereof;
FIG. 3 is a right side view thereof;
FIG. 4 is rear view thereof;
FIG. 5 is a left side view thereof; and,
FIG. 6 is a top view thereof.
The portions shown in dashed lines are shown for illustrative purposes only and form no part of the claimed design.

1 Claim, 6 Drawing Sheets

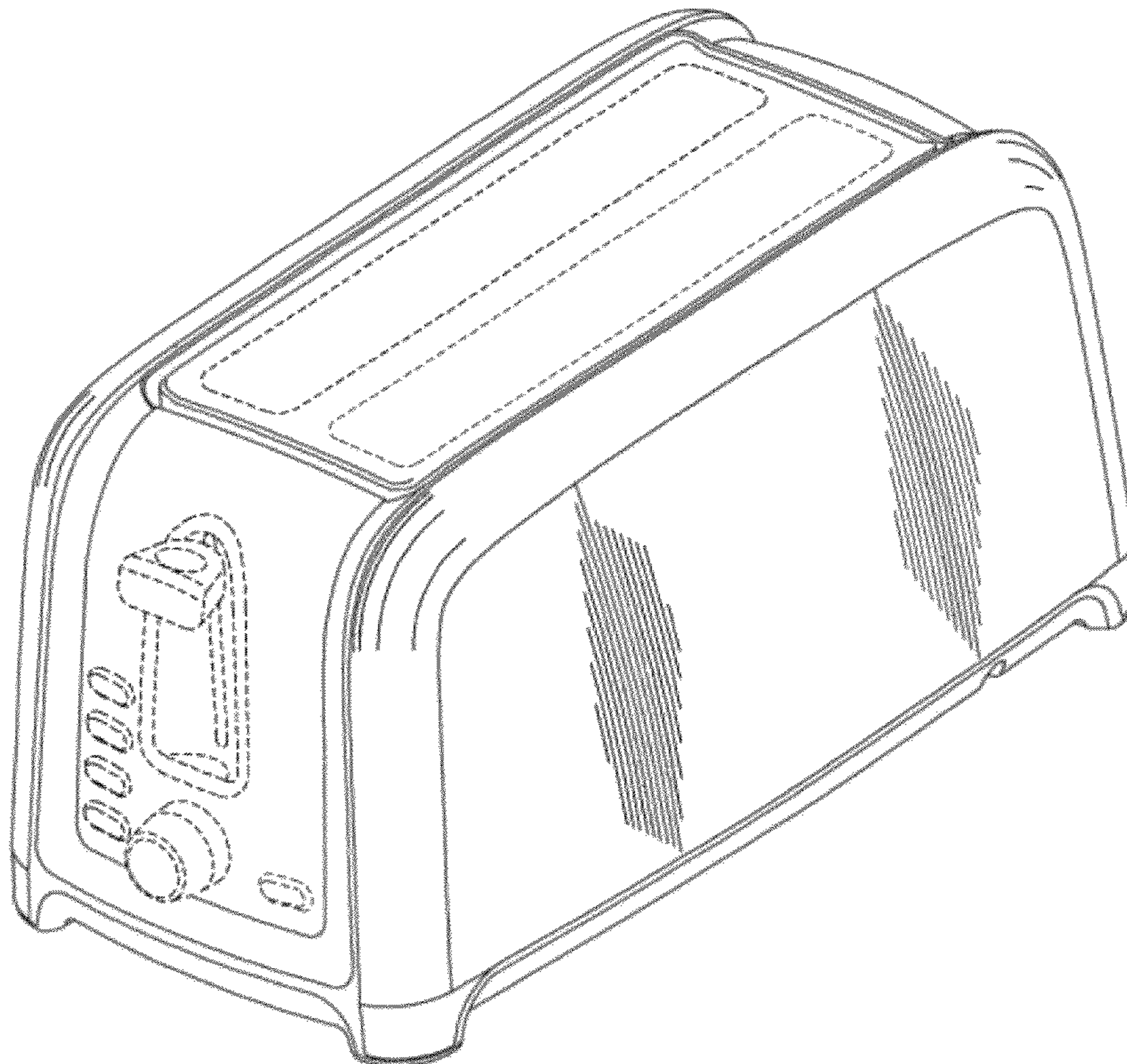

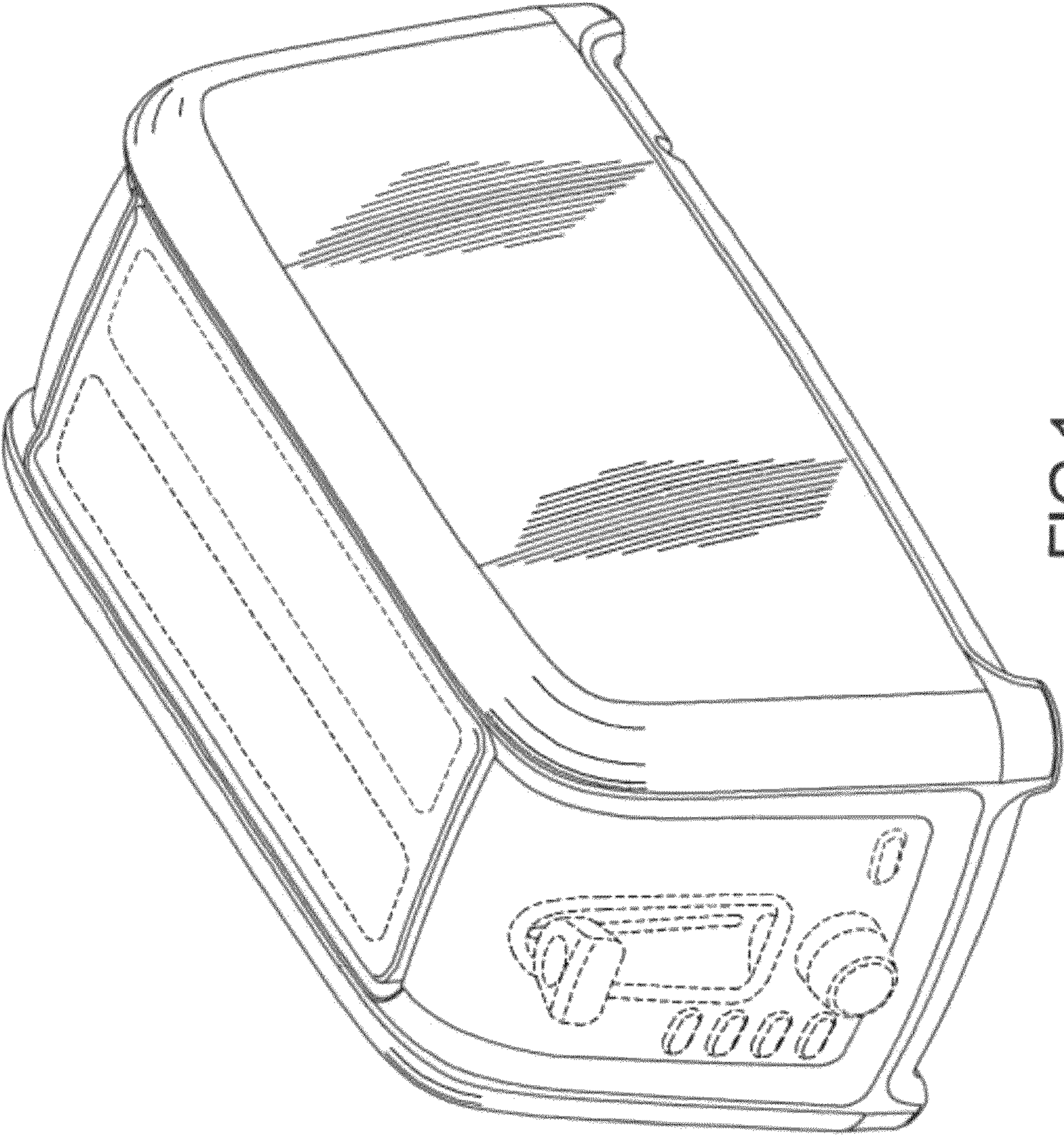

FIG 1

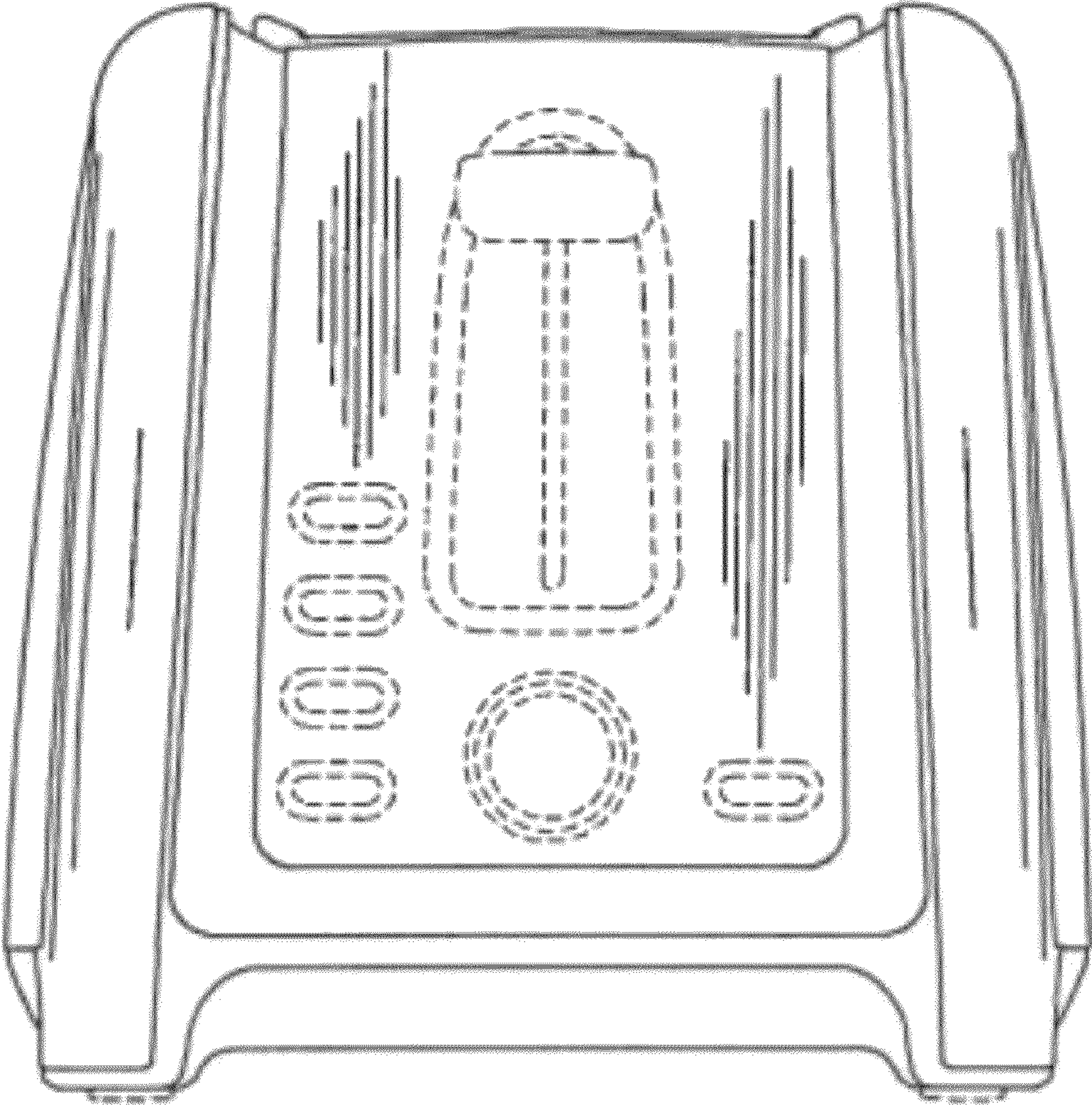

FIG 2

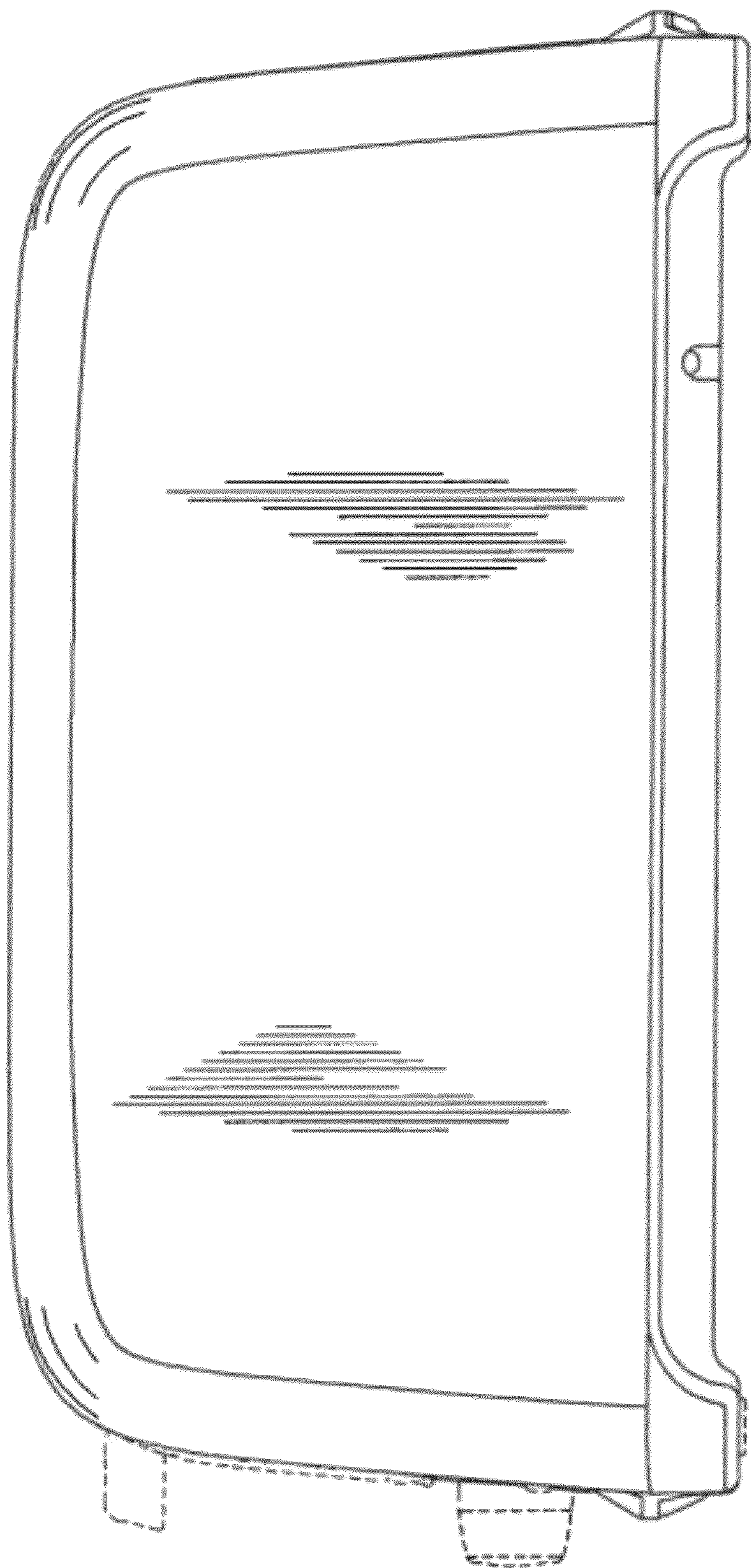

FIG 3

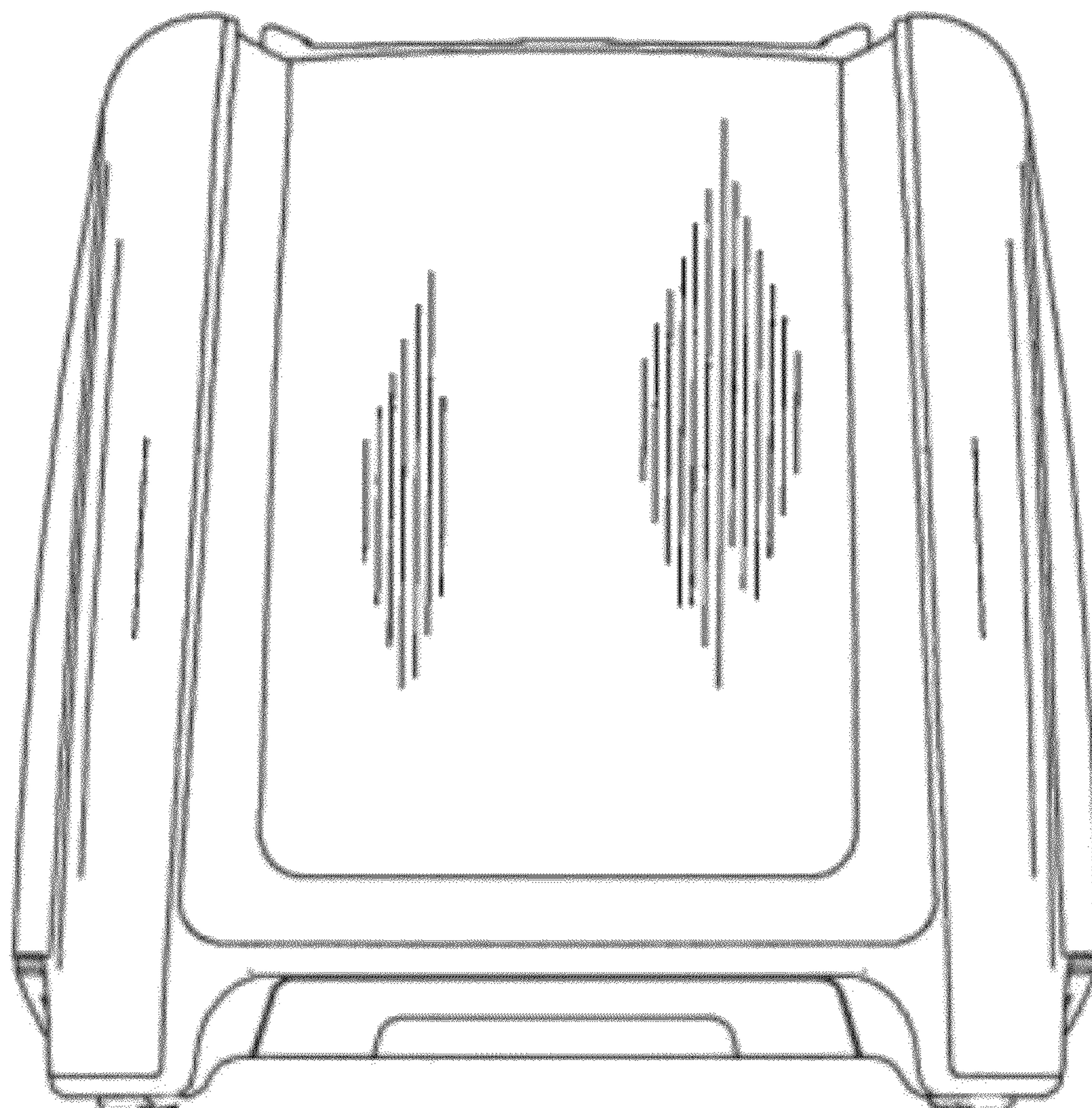

FIG 4

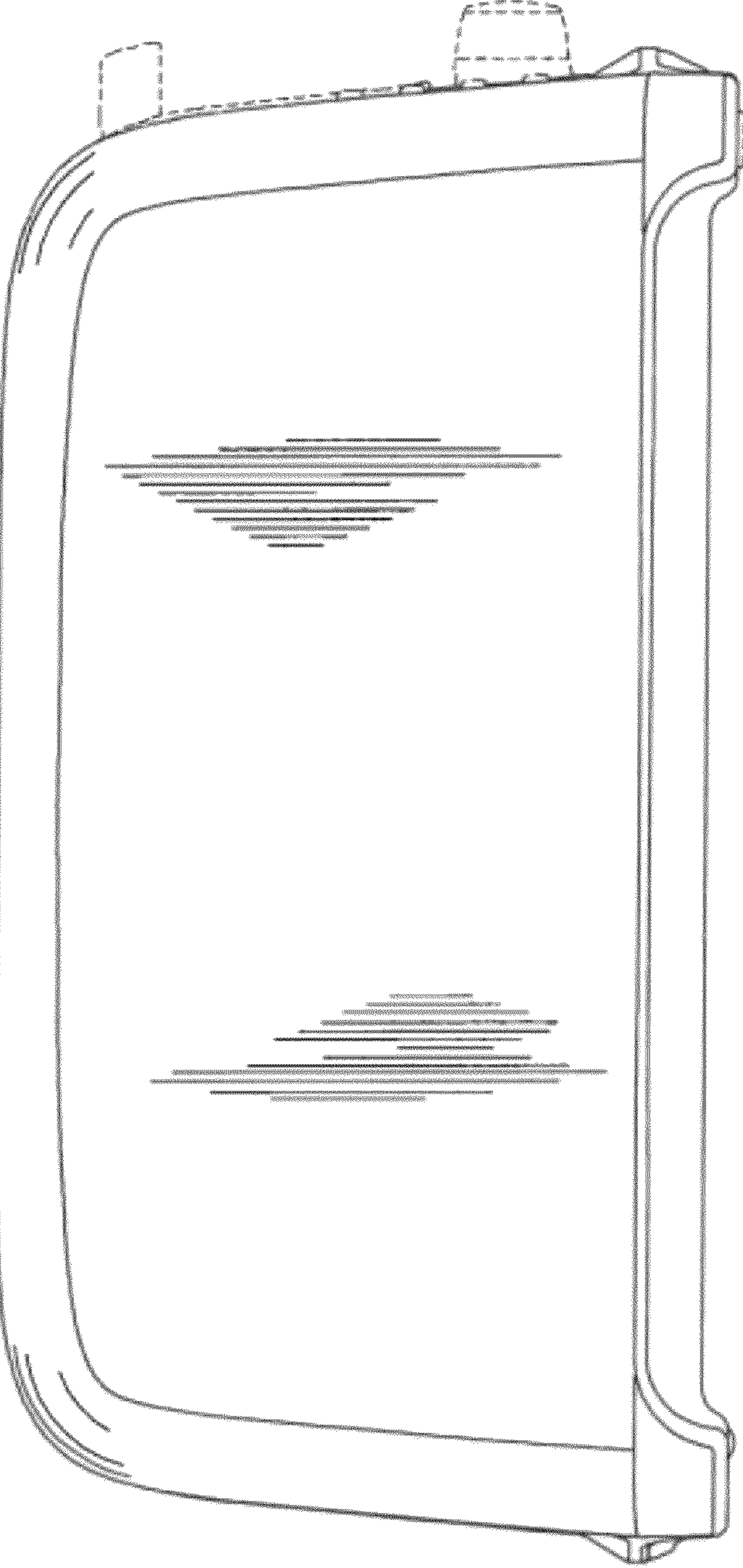

FIG 5

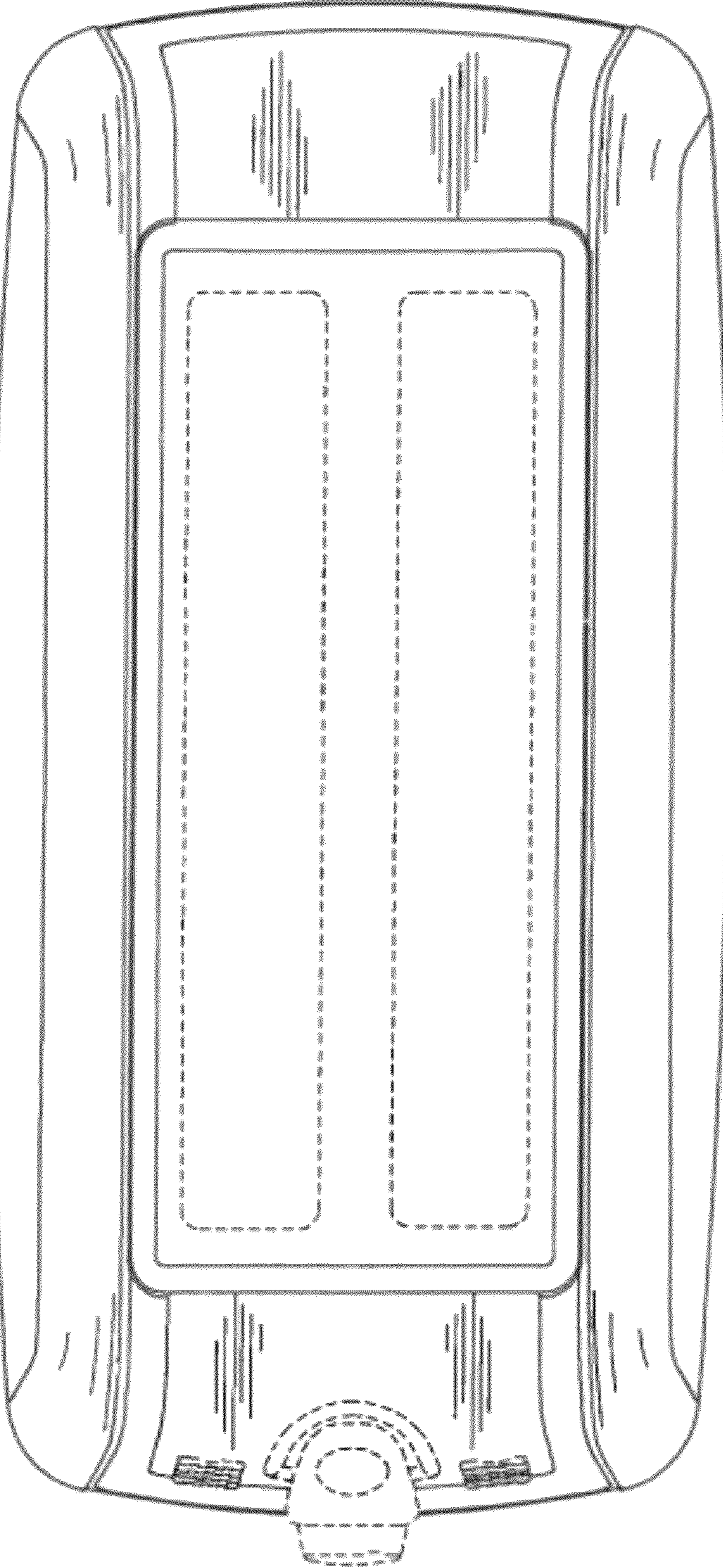

FIG 6