

US00D661910S

(12) **United States Design Patent**
Yang et al.

(10) **Patent No.:** **US D661,910 S**
(45) **Date of Patent:** **** Jun. 19, 2012**

(54) **ANTI-FOG MIRROR**

(75) Inventors: **Frank Yang**, Rancho Palos Verdes, CA (US); **Tzu-Hao Wei**, Hacienda Heights, CA (US); **Di-Fong Chang**, Torrance, CA (US); **Myk Lum**, Irvine, CA (US); **Won Song**, Tustin, CA (US)

(73) Assignee: **SimpleHuman LLC**, Torrance, CA (US)

(**) Term: **14 Years**

(21) Appl. No.: **29/368,575**

(22) Filed: **Aug. 25, 2010**

(51) **LOC (9) Cl.** **06-07**

(52) **U.S. Cl.** **D6/312**

(58) **Field of Classification Search** D6/300-314;
40/700, 711, 714, 719-722, 735, 738, 597,
40/744, 745, 754, 765, 768, 769, 798, 747;
248/469, 467; D14/439, 448

See application file for complete search history.

(56) **References Cited**

U.S. PATENT DOCUMENTS

D445,798 S * 7/2001 Moore D14/439
D447,750 S * 9/2001 Bell D14/448

6,543,168 B1 * 4/2003 Moore 40/747
D532,207 S * 11/2006 Snell D6/300
D591,517 S * 5/2009 Molenaar et al. D6/300

* cited by examiner

Primary Examiner — Philip S Hyder

Assistant Examiner — Sydney Buffalow

(74) *Attorney, Agent, or Firm* — Liu & Liu

(57) **CLAIM**

The ornamental design for an anti-fog mirror, as shown and described.

DESCRIPTION

FIG. 1 is a left perspective view of an anti-fog mirror showing our new design;

FIG. 2 is a front view thereof;

FIG. 3 is a rear view thereof (the broken lines illustrate non-claimed subject matter and form no part of the claimed design);

FIG. 4 is a left side view thereof (right side view is a mirror image thereof);

FIG. 5 is a top plan view thereof;

FIG. 6 is a bottom plan view thereof; and,

FIG. 7 is a right perspective view thereof (the broken lines are directed to environment, and are for informational purposes only and form no part of the claimed design).

1 Claim, 7 Drawing Sheets

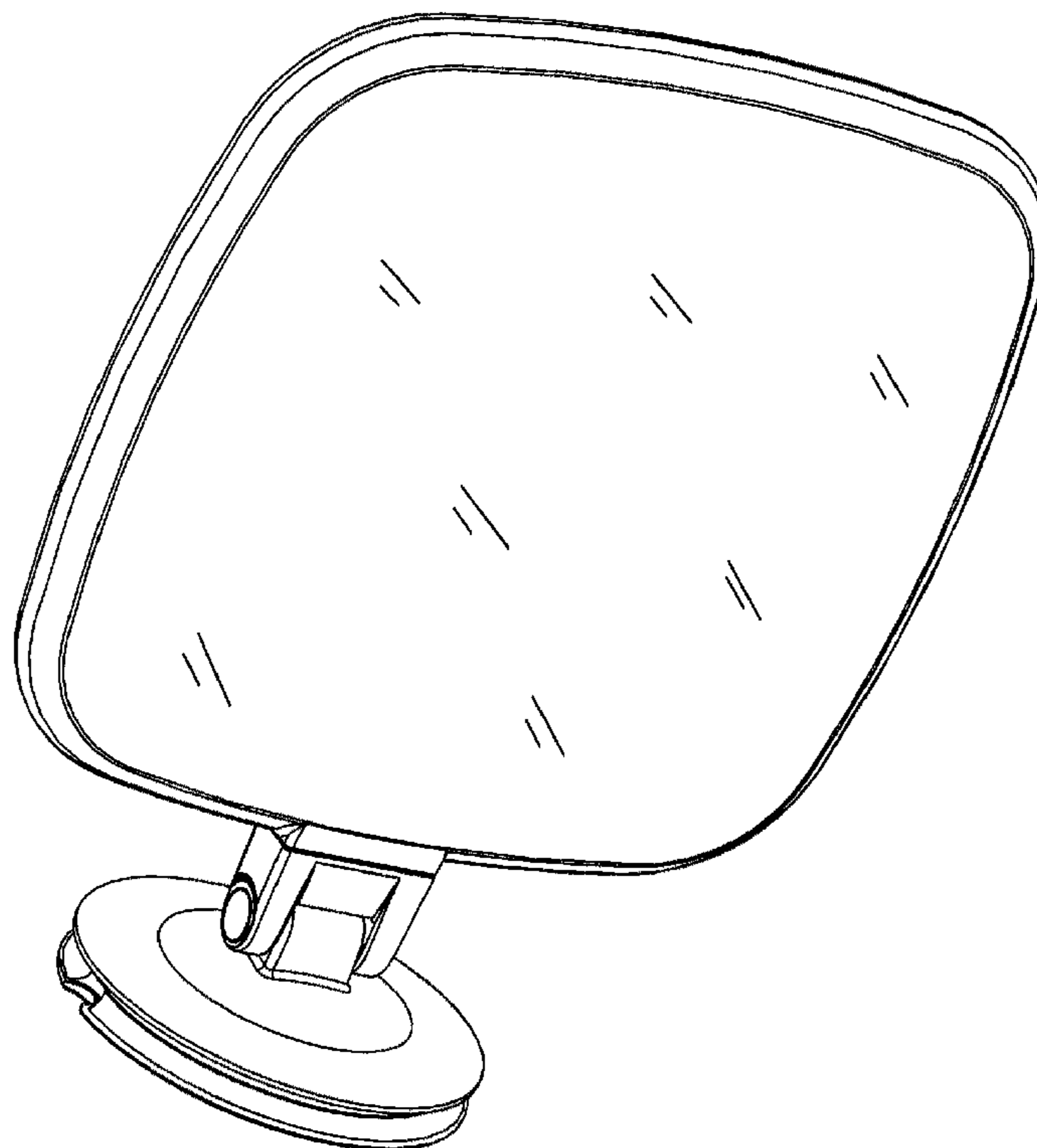

FIG. 1

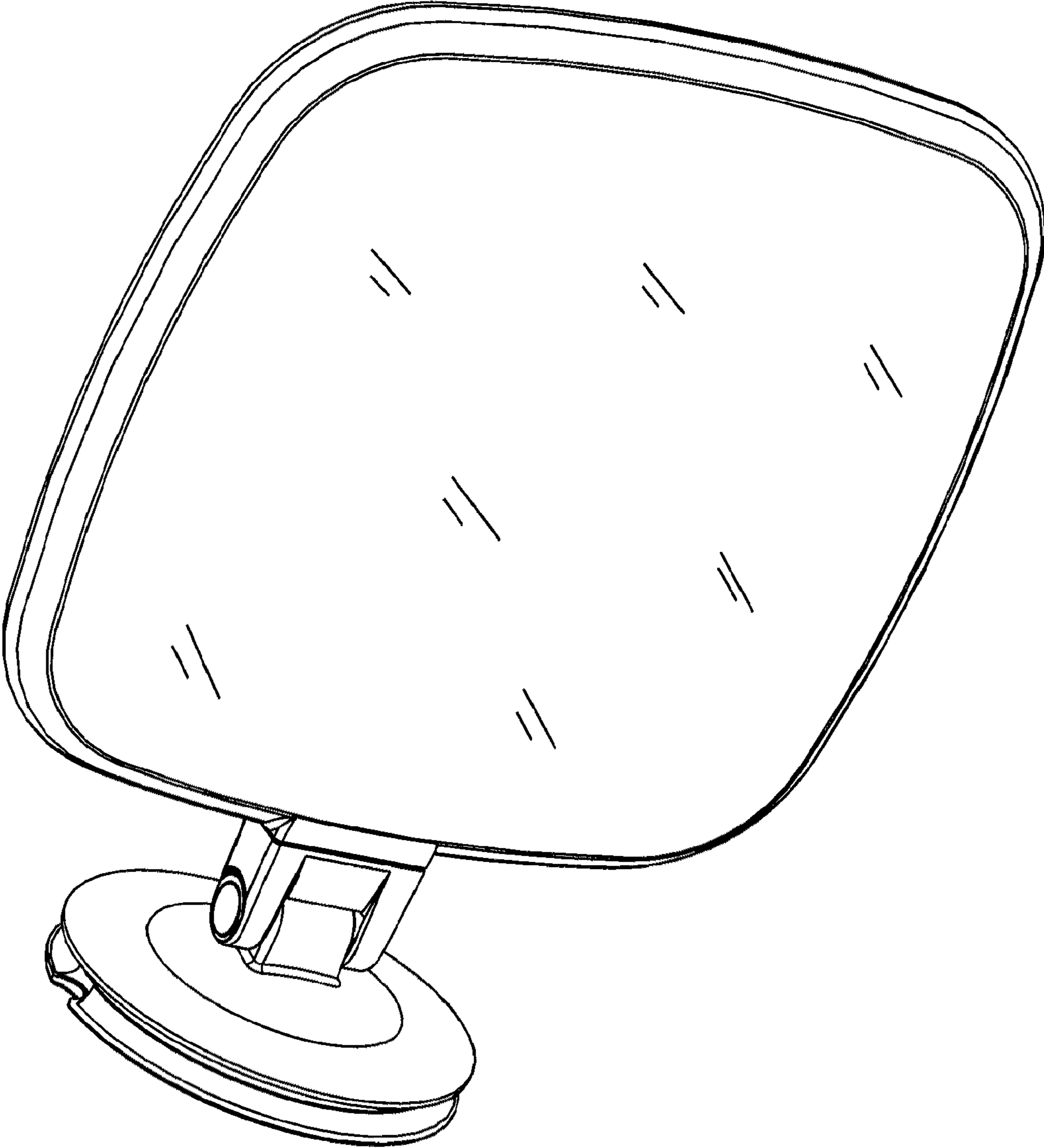

FIG. 2

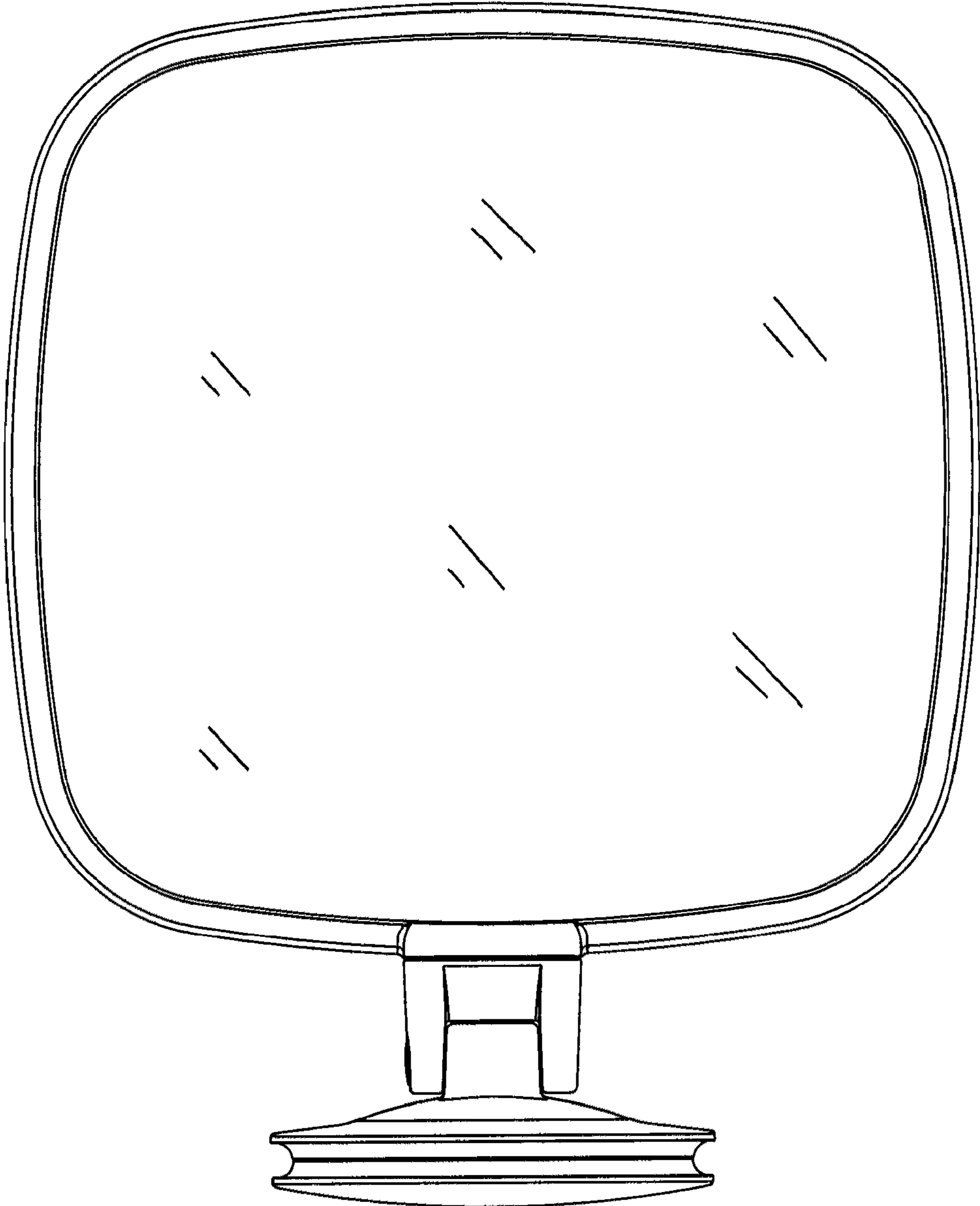

FIG. 3

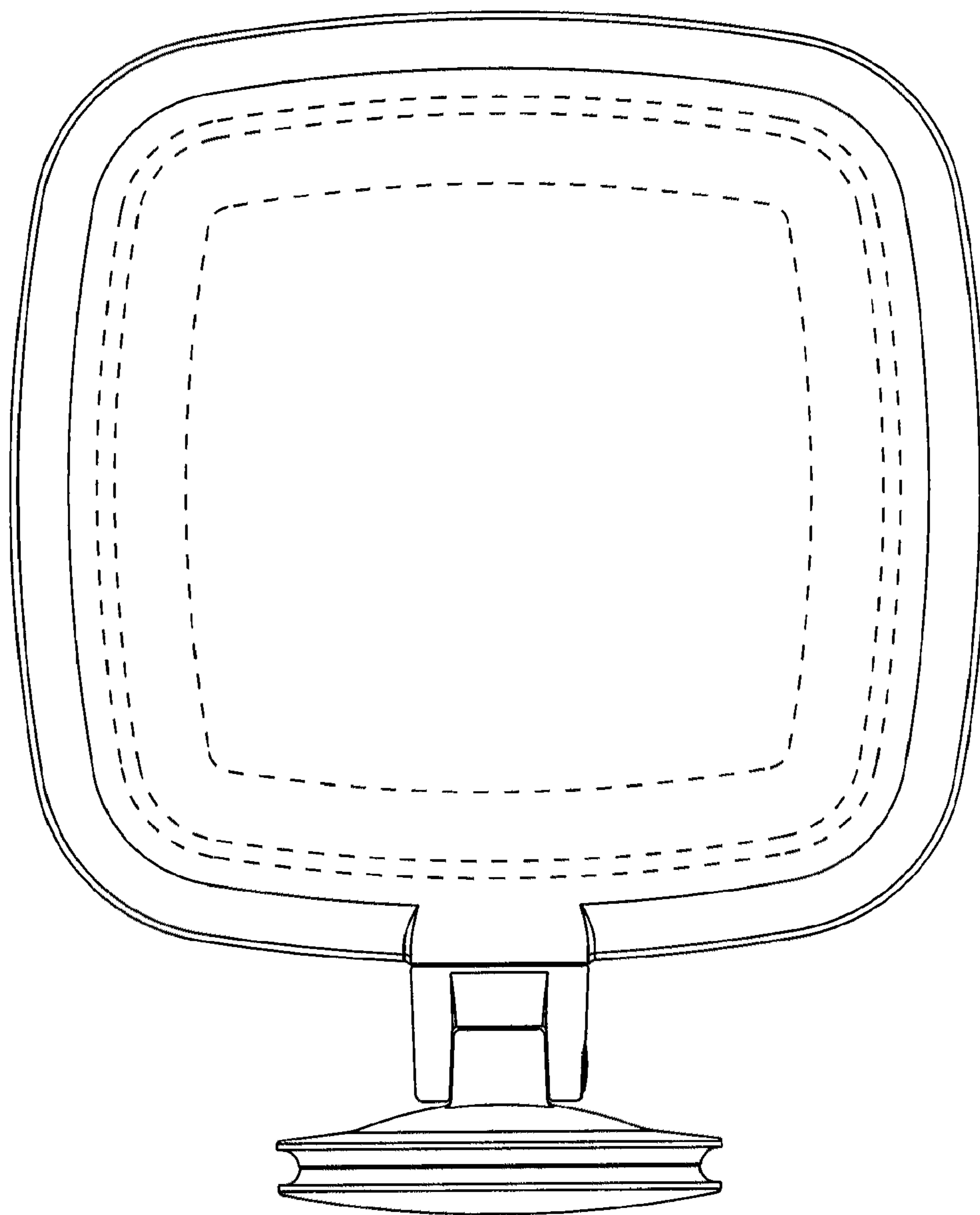

FIG. 4

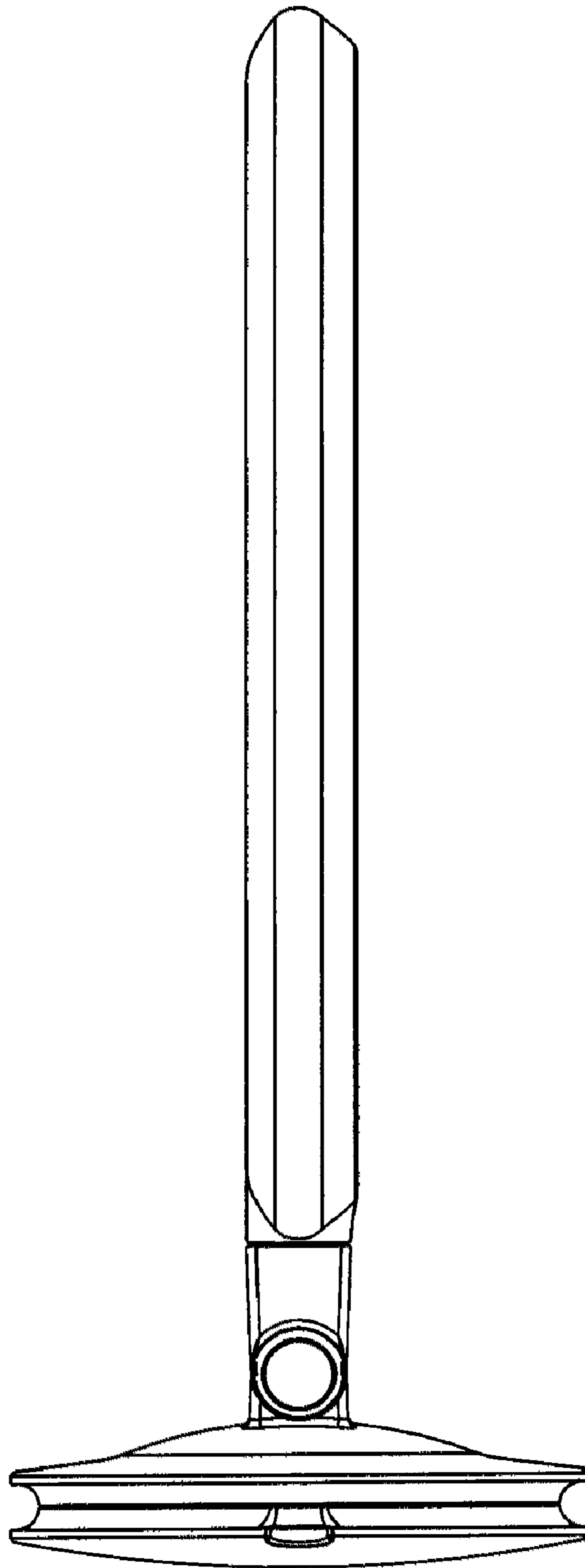

FIG. 5

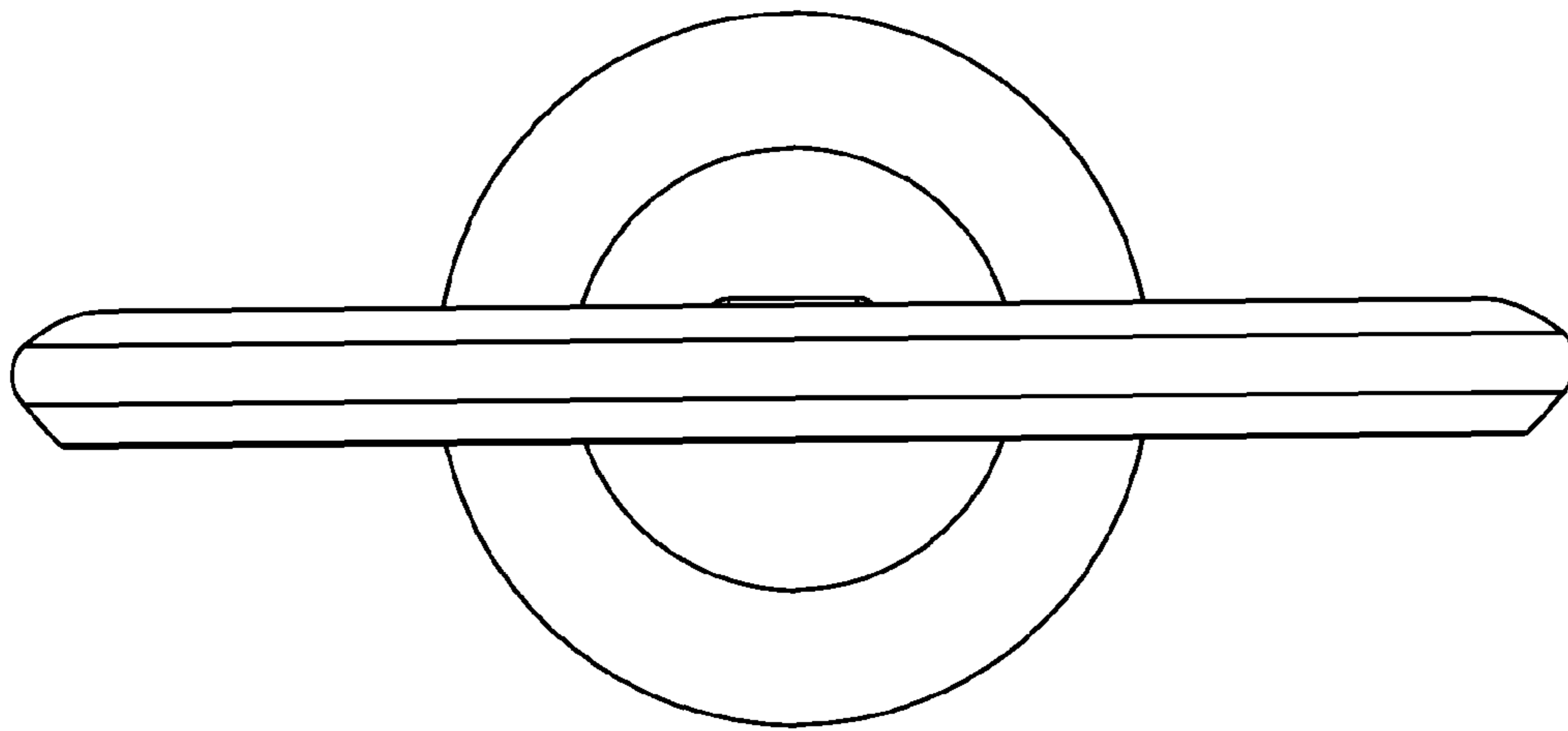

FIG. 6

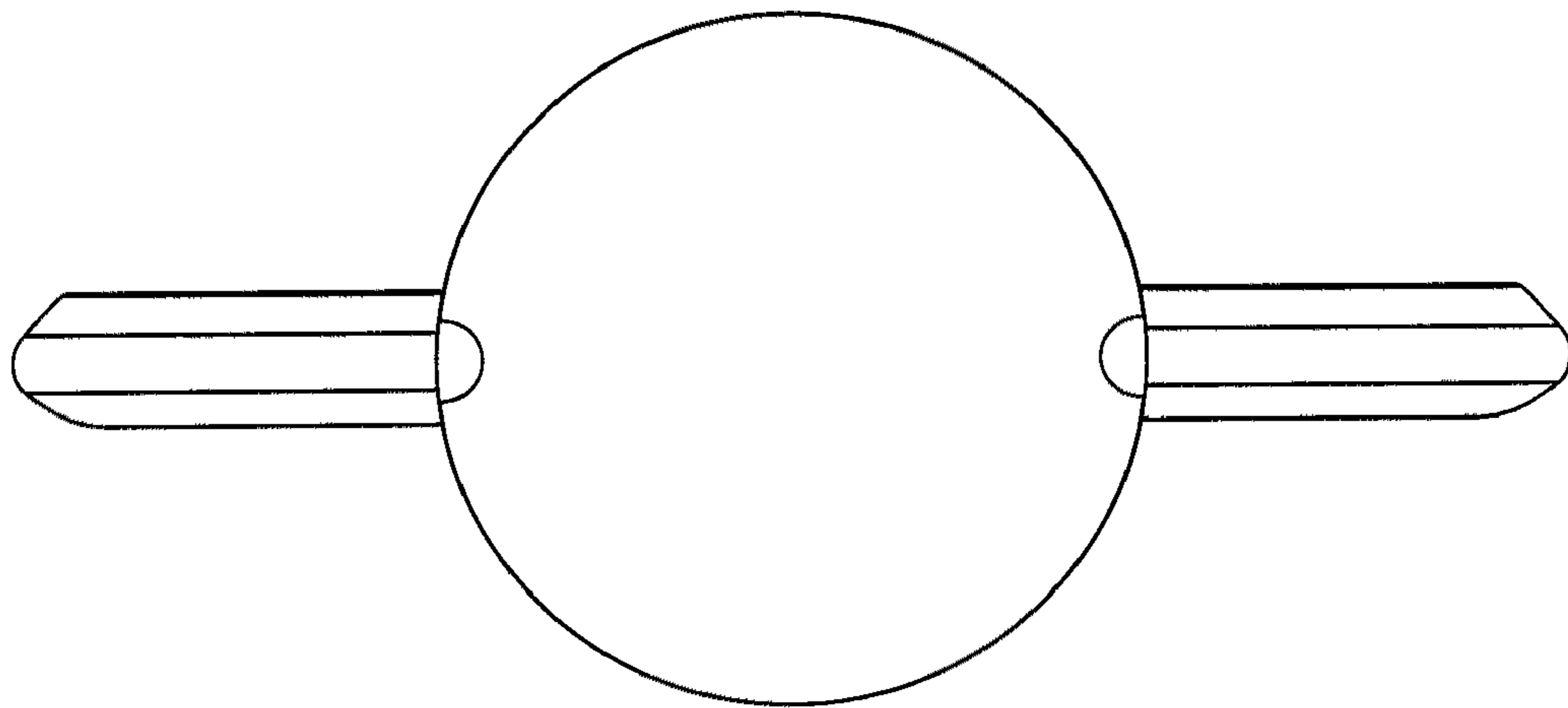

FIG. 7

