

US00D661870S

(12) **United States Design Patent**
Robles

(10) **Patent No.:** **US D661,870 S**
(45) **Date of Patent:** **** Jun. 19, 2012**

(54) **PROTECTIVE HYGIENIC UNDERWEAR**

(76) Inventor: **Katherine M. Robles**, Seattle, WA (US)

(**) Term: **14 Years**

(21) Appl. No.: **29/413,818**

(22) Filed: **Feb. 21, 2012**

(51) **LOC (9) Cl.** **02-01**

(52) **U.S. Cl.** **D2/712**

(58) **Field of Classification Search** D2/712,
D2/713, 714, 715, 716, 731, 736, 737, 739,
D2/742, 863, 864; D24/124, 125, 126, 190;
2/67, 73, 78.1, 78.2, 78.3, 227, 228, 238,
2/400, 401, 402, 403, 404, 405, 406, 407,
2/408; 450/100, 101, 102, 103, 104; 602/67;
604/345, 358, 361, 393, 394, 395, 396, 397,
604/398, 399

See application file for complete search history.

(56) **References Cited**

U.S. PATENT DOCUMENTS

451,051	A *	4/1891	Holmes	2/401
541,334	A *	6/1895	Roschi	2/227
1,182,866	A *	5/1916	van Heusen	2/78.2
1,999,433	A *	4/1935	Weiss	2/407
2,145,688	A *	1/1939	Flamberg	2/401
2,191,169	A *	2/1940	Katz	2/404
2,215,291	A *	9/1940	Hurd	2/78.2
D157,666	S *	3/1950	Eudy	D2/712
4,114,621	A *	9/1978	Mims, Jr.	604/361
4,938,757	A *	7/1990	Van Gompel et al.	604/396

4,961,233	A *	10/1990	Black	2/228
5,390,376	A *	2/1995	Marx et al.	2/406
D414,012	S *	9/1999	Tobias	D2/742
6,245,036	B1 *	6/2001	McRoberts et al.	602/67
D466,675	S *	12/2002	LaPeau	D2/742
D537,525	S *	2/2007	Buchanan	D24/124
7,354,424	B2 *	4/2008	Giloh	604/385.07
2011/0016607	A1 *	1/2011	Ashmore et al.	2/159

* cited by examiner

Primary Examiner — Karen E Eldridge Powers

(74) *Attorney, Agent, or Firm* — Albert O. Cota

(57) **CLAIM**

The ornamental design for a protective hygienic underwear, as shown and described.

DESCRIPTION

FIG. 1 is a front elevational view of a protective hygienic underwear showing my new design;
FIG. 2 is a rear elevational view thereof;
FIG. 3 is a top plan view thereof;
FIG. 4 is a bottom plan view thereof;
FIG. 5 is a left-side elevational view thereof;
FIG. 6 is a right-side elevational view thereof;
FIG. 7 is a front orthographic view of the protective hygienic underwear shown on a human body; and,
FIG. 8 is a rear orthographic view of the protective hygienic underwear shown on a human body.

The partial human body shown in broken lines in the drawings illustrates the environment in which the design is used, and assists in showing how the claimed design appears when worn. The broken-line subject matter forms no part of the claim.

1 Claim, 4 Drawing Sheets

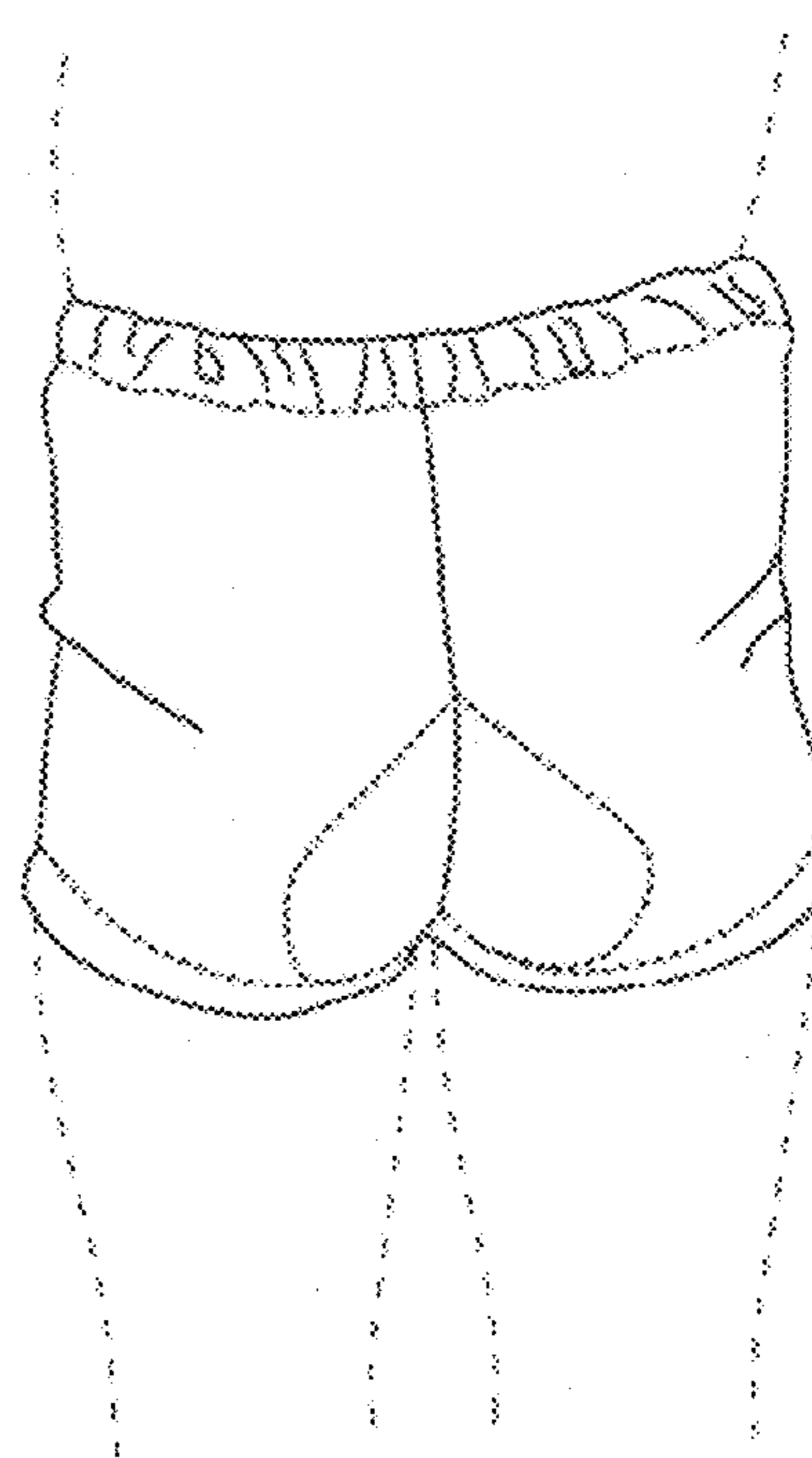
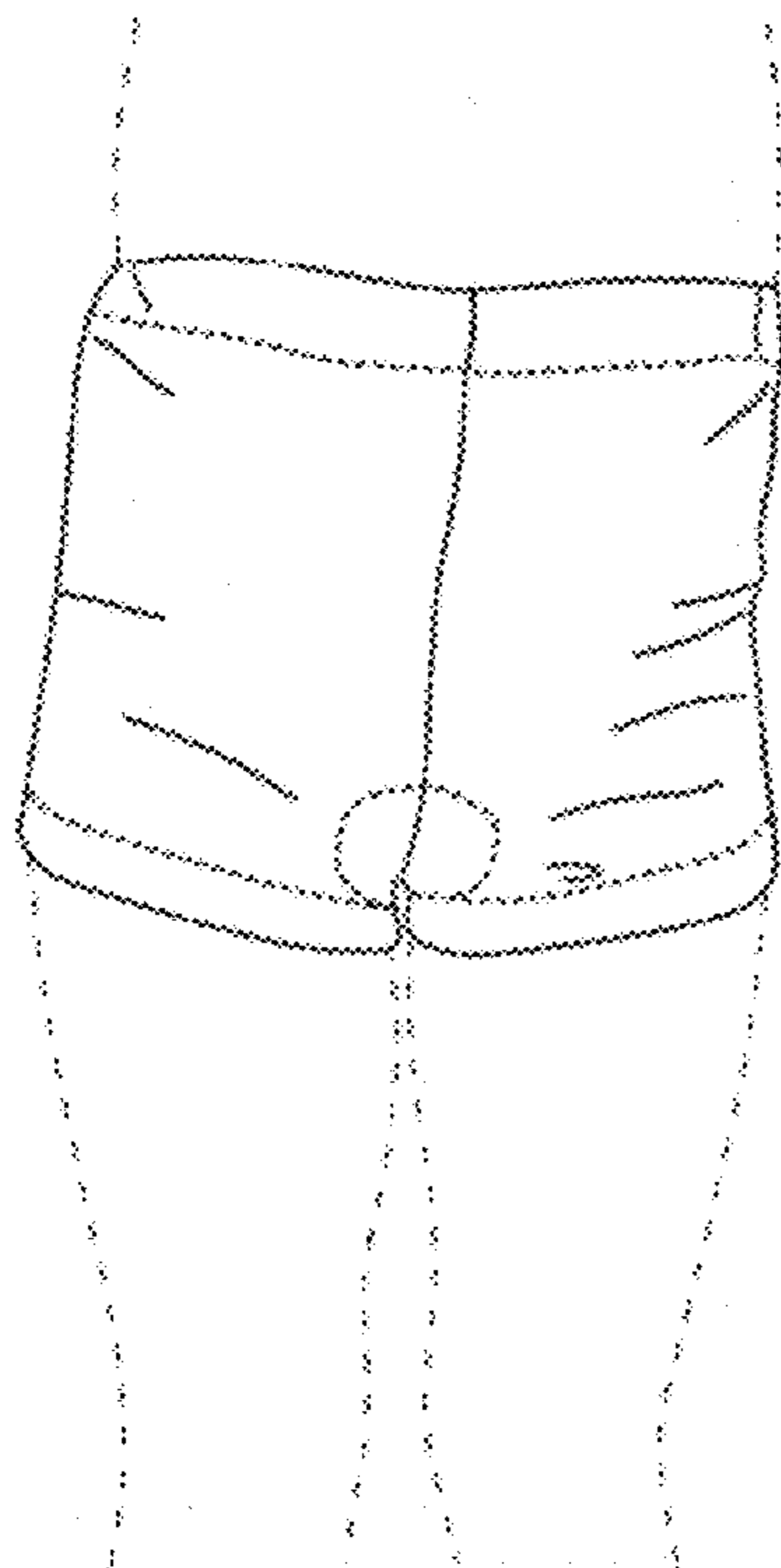

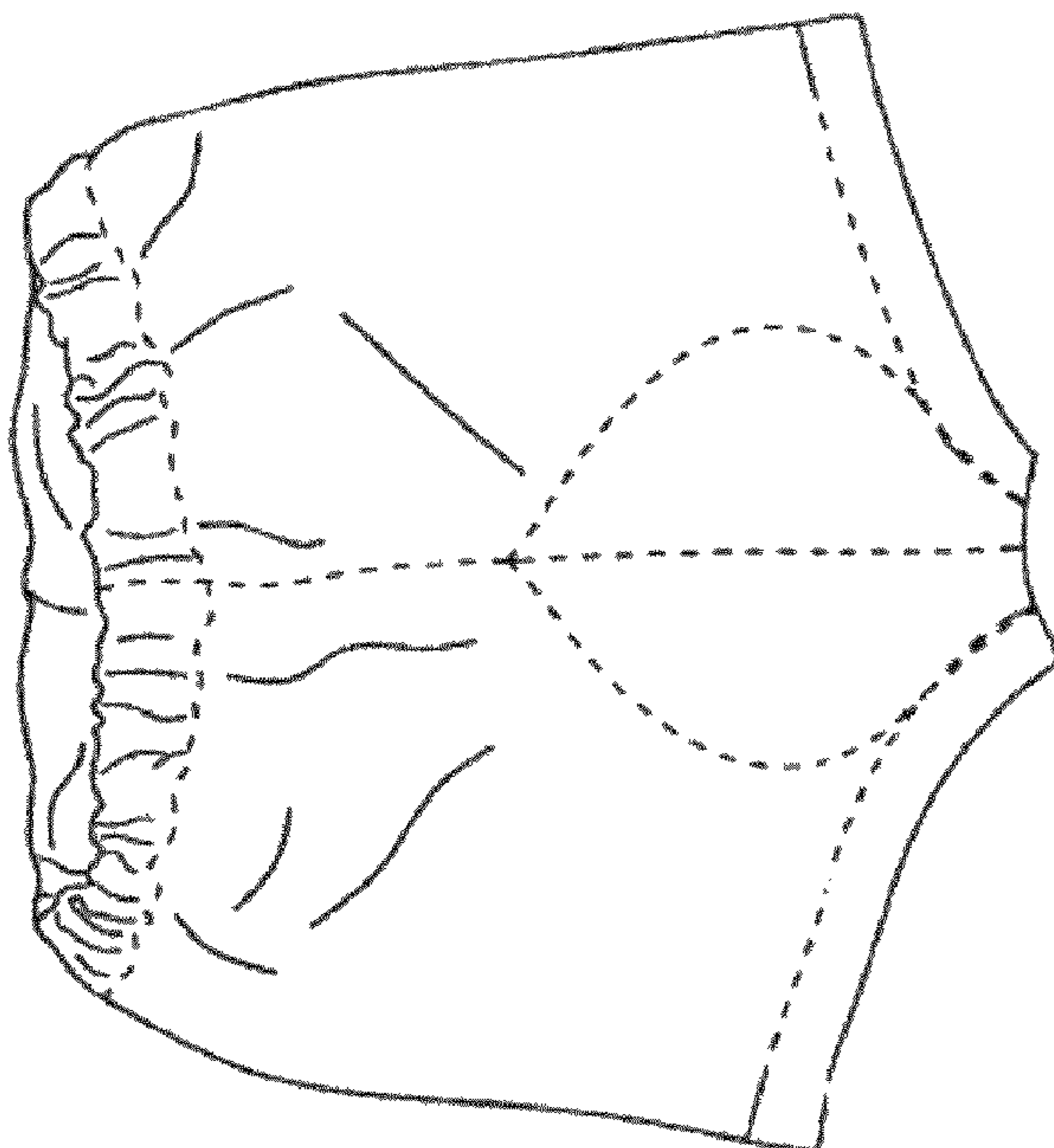

Fig. 2

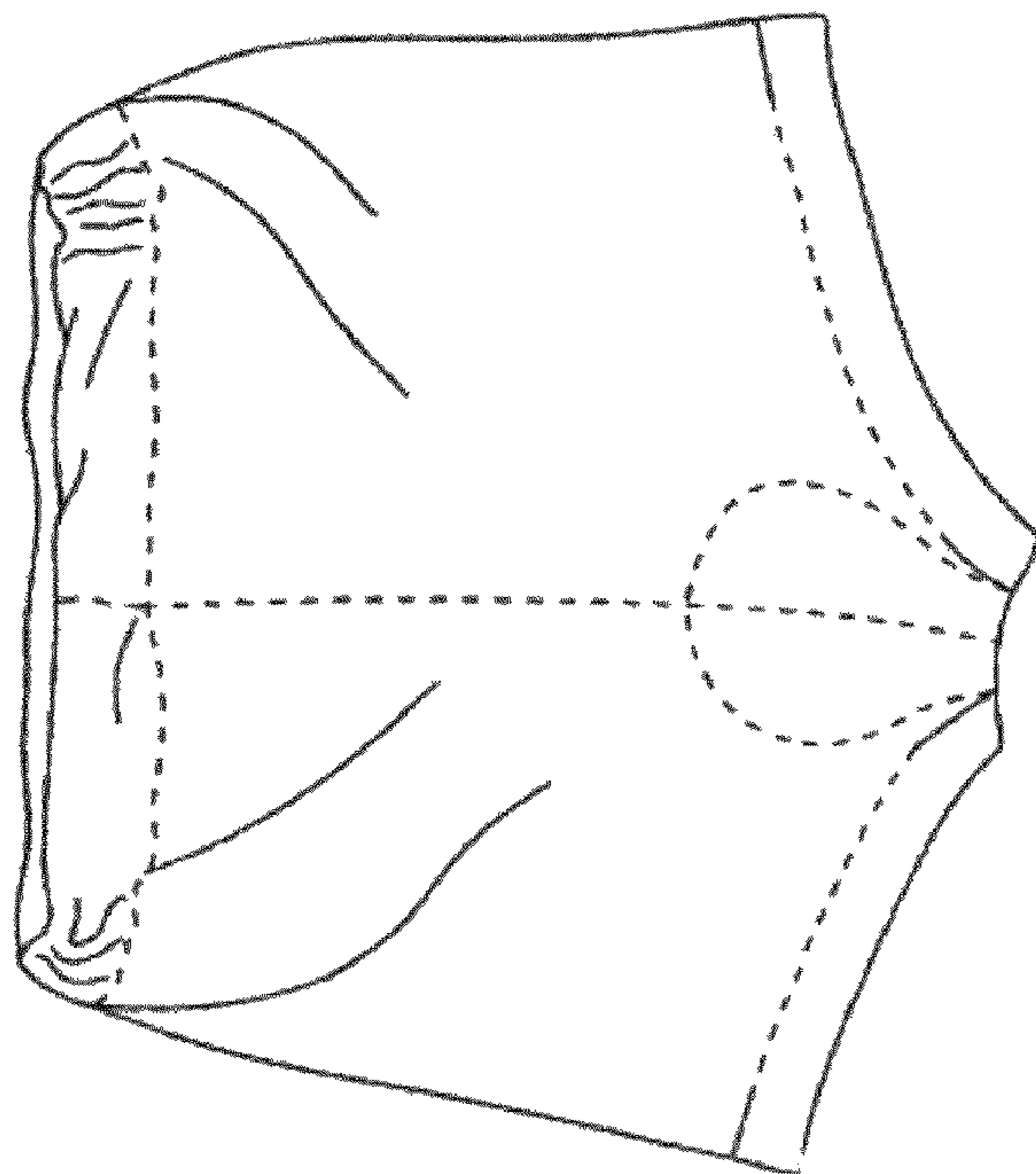

Fig. 1

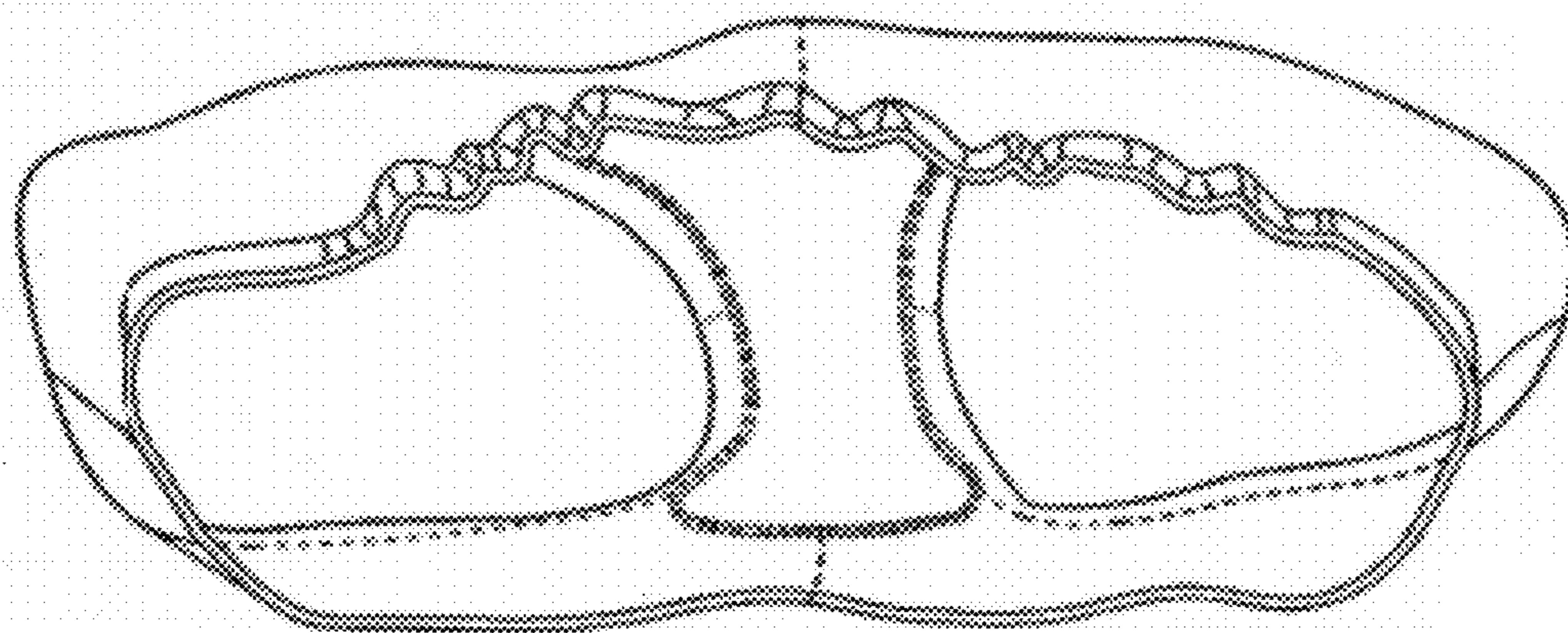

Fig. 3

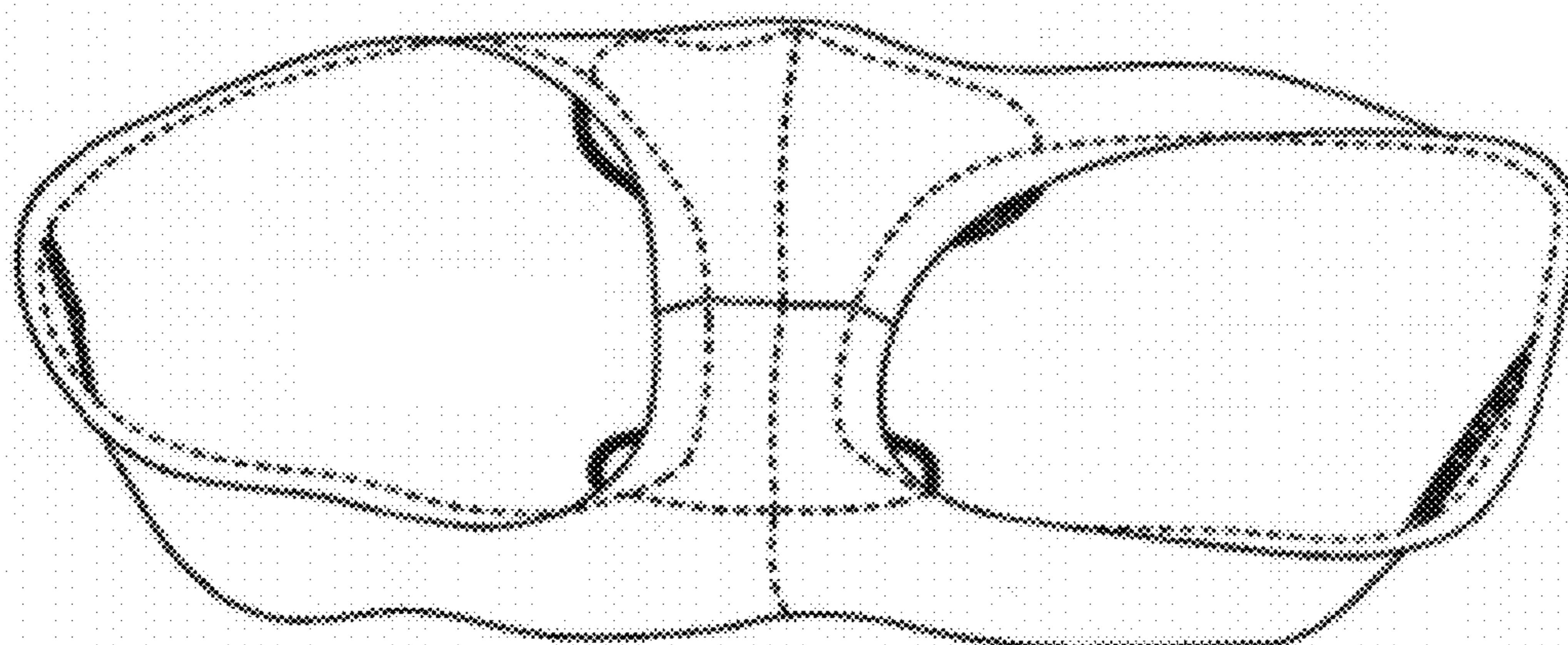

Fig. 4

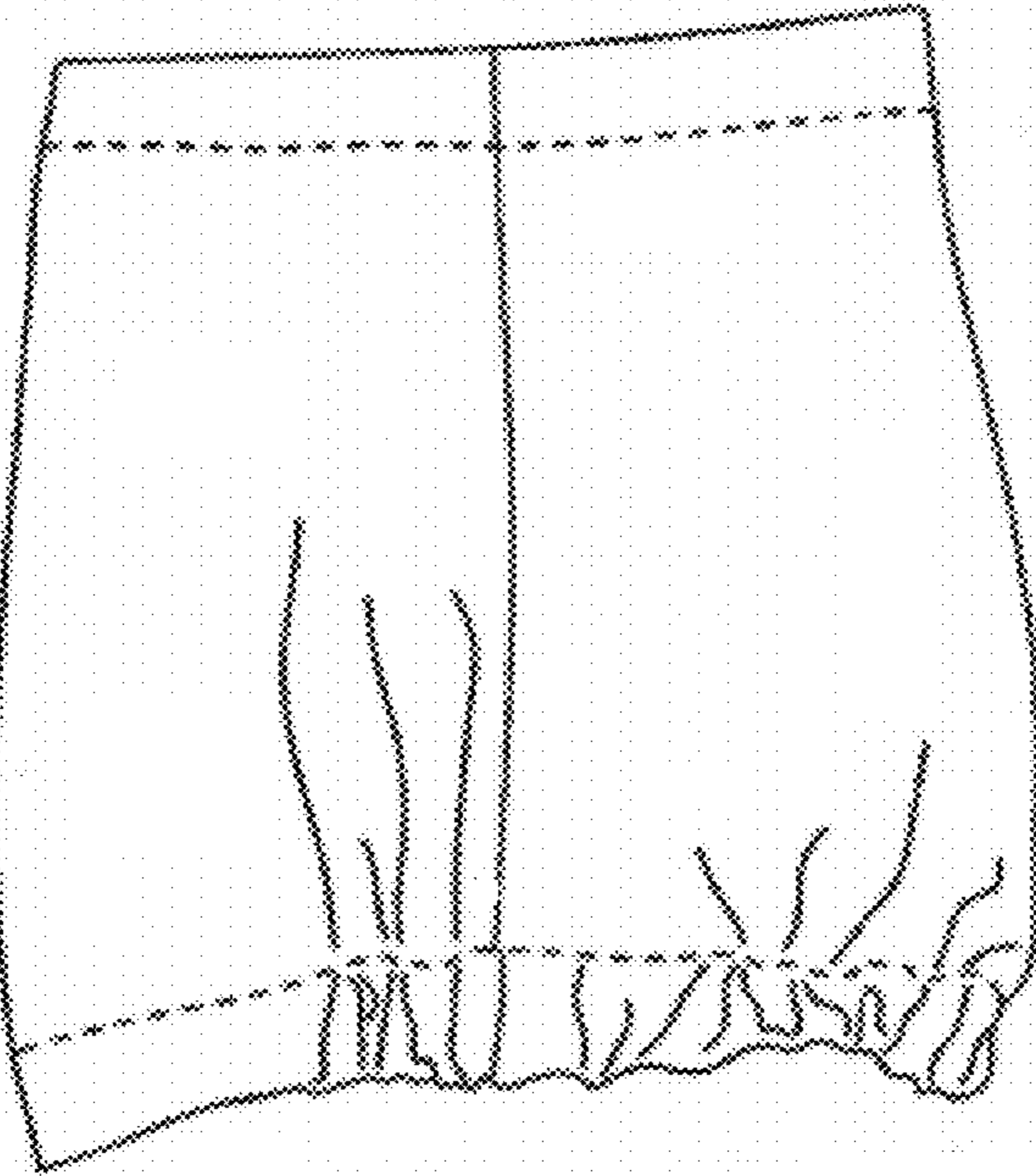

Fig. 5

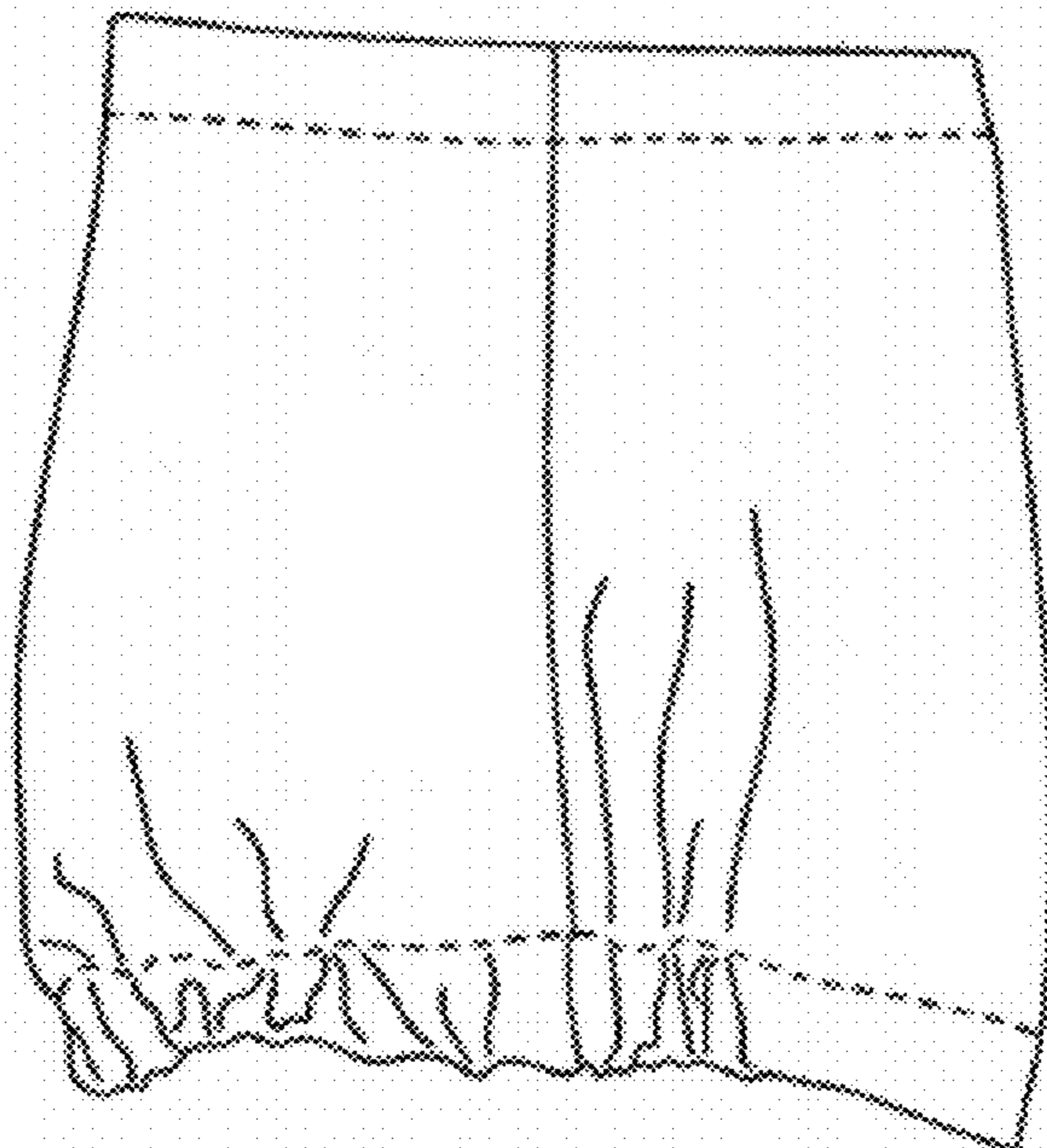

Fig. 6

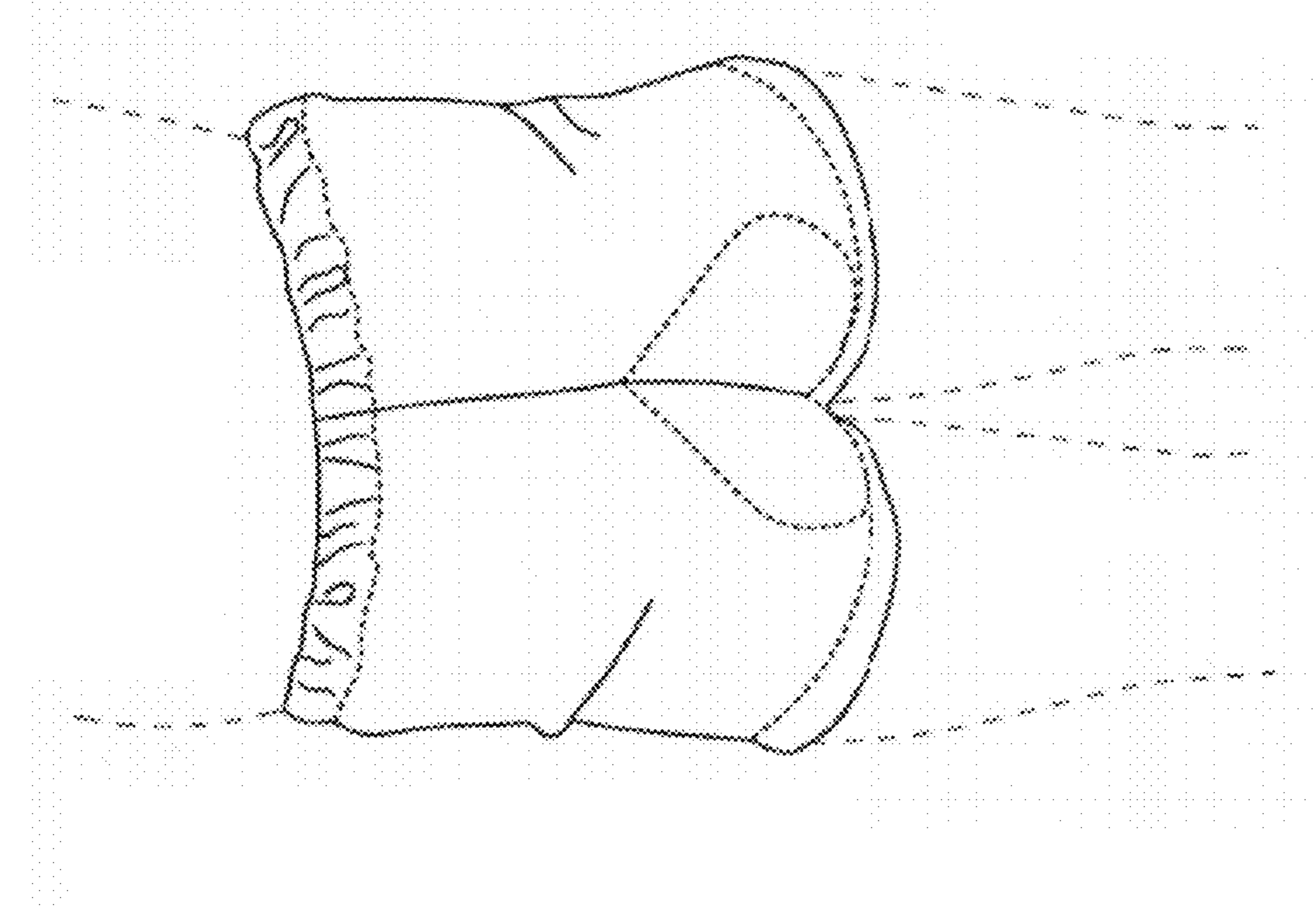

Fig. 7

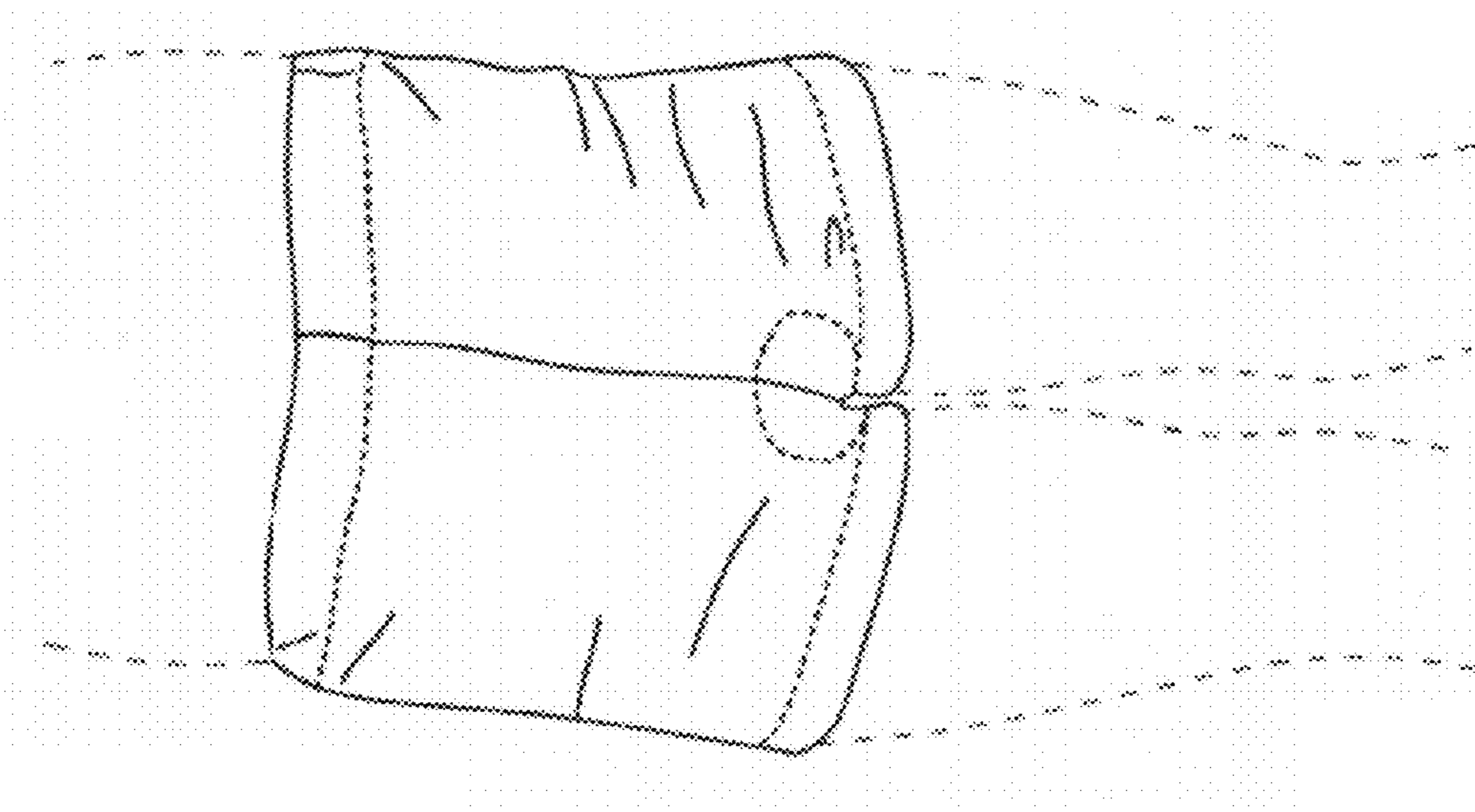

Fig. 8