

US00D661843S

(12) **United States Design Patent**  
**Saranga**

(10) **Patent No.:** **US D661,843 S**  
(45) **Date of Patent:** **\*\* Jun. 12, 2012**

- (54) **KNEE AND SHIN PROTECTOR**
- (76) Inventor: **John Saranga**, Lockport, IL (US)
- (\*\*) Term: **14 Years**
- (21) Appl. No.: **29/413,230**
- (22) Filed: **Feb. 13, 2012**

**Related U.S. Application Data**

- (63) Continuation of application No. 29/404,427, filed on Oct. 20, 2011, now Pat. No. Des. 656,278.
  - (51) **LOC (9) Cl.** ..... **29-02**
  - (52) **U.S. Cl.** ..... **D29/121.1**
  - (58) **Field of Classification Search** ..... D29/100, D29/101.1, 101.2, 101.3, 101.4, 101.5, 120.1, D29/120.2, 121.1, 121.2; D2/901; D24/190; 2/16, 20-24, 62, 267, 455, 461, 463, 910, 2/911; 602/3, 5, 6, 16, 23, 26
- See application file for complete search history.

**References Cited**

**U.S. PATENT DOCUMENTS**

- 909,215 A 1/1909 Pierce et al.
- 2,785,407 A \* 3/1957 Reeder ..... 2/22
- 3,735,419 A 5/1973 Byrd
- D264,140 S \* 5/1982 Jenkins ..... D29/120.1
- D284,038 S \* 6/1986 Eghamn et al. .... D29/120.1
- 4,999,847 A 3/1991 Barcelo
- D351,255 S \* 10/1994 Pytlewski ..... D29/121.1
- D353,702 S 12/1994 Martinez et al.
- D355,052 S 1/1995 Paikos et al.
- D361,162 S 8/1995 Fierek
- 5,477,559 A 12/1995 Clement
- D374,746 S 10/1996 Skottheim
- D377,851 S 2/1997 Dancyger
- D408,596 S 4/1999 Dancyger
- 6,178,555 B1 1/2001 Williams
- 6,253,376 B1 7/2001 Ritter
- D449,715 S 10/2001 Wolf
- D456,955 S 5/2002 Pytlewski
- D459,838 S \* 7/2002 Parkins ..... D29/121.1
- D463,886 S 10/2002 Cantu, Jr.
- D464,177 S 10/2002 Troxell
- 6,654,961 B2 12/2003 Beland
- D492,068 S 6/2004 Peterson et al.
- 6,789,264 B2 \* 9/2004 Budda ..... 2/22
- 6,795,974 B1 9/2004 Howell

- D500,395 S 12/2004 Yang
  - D504,981 S 5/2005 Vanderhoef
  - 7,013,487 B2 \* 3/2006 Beland ..... 2/22
  - D518,922 S \* 4/2006 Beland ..... D29/122
  - D588,310 S 3/2009 Dancyger et al.
  - D595,016 S \* 6/2009 Menegon ..... D30/146
  - D602,210 S 10/2009 Crye
  - D618,401 S \* 6/2010 Menegon ..... D30/146
  - D638,995 S 5/2011 Hanlon
  - 8,141,169 B2 \* 3/2012 Saranga ..... 2/22
  - 2004/0255336 A1 \* 12/2004 Logan et al. .... 725/135
  - 2009/0025114 A1 \* 1/2009 Hudon et al. .... 2/22
- \* cited by examiner

*Primary Examiner* — Raphael Barkai  
*Assistant Examiner* — Randall Gholson  
(74) *Attorney, Agent, or Firm* — Maier & Maier, PLLC

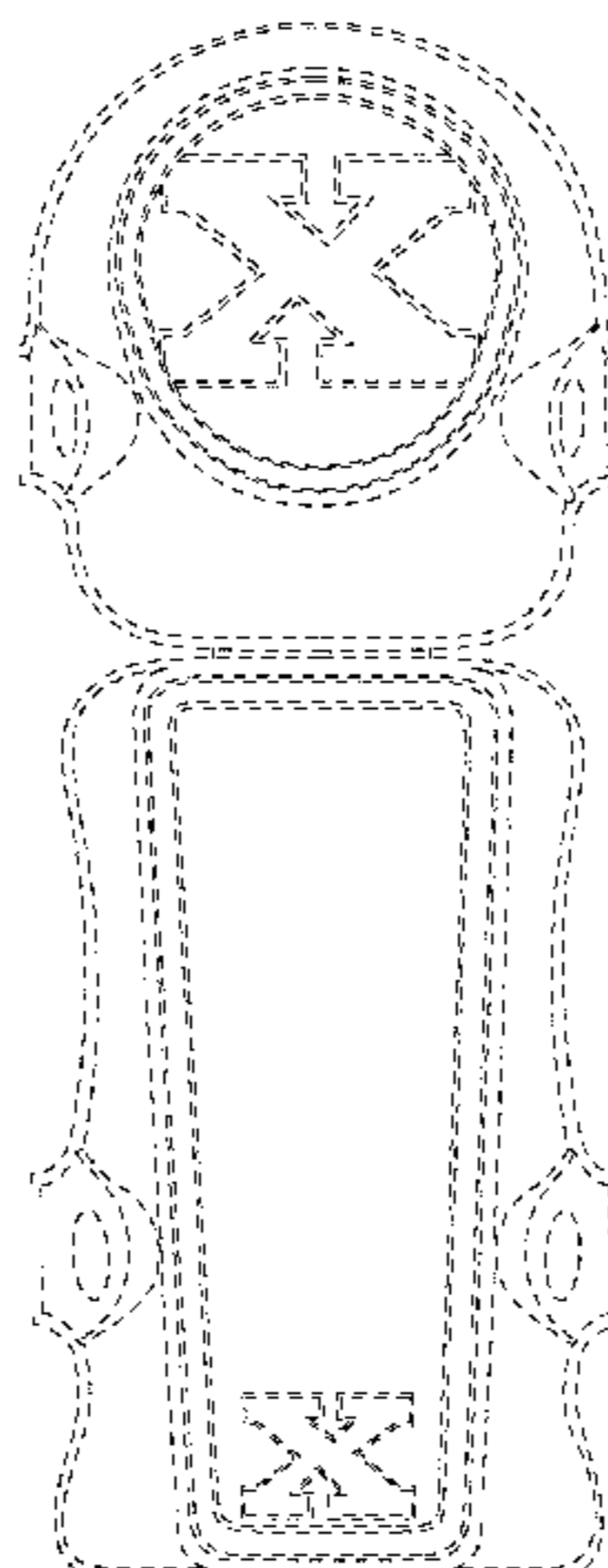
(57) **CLAIM**  
The ornamental design for a knee and shin protector, as shown and described.

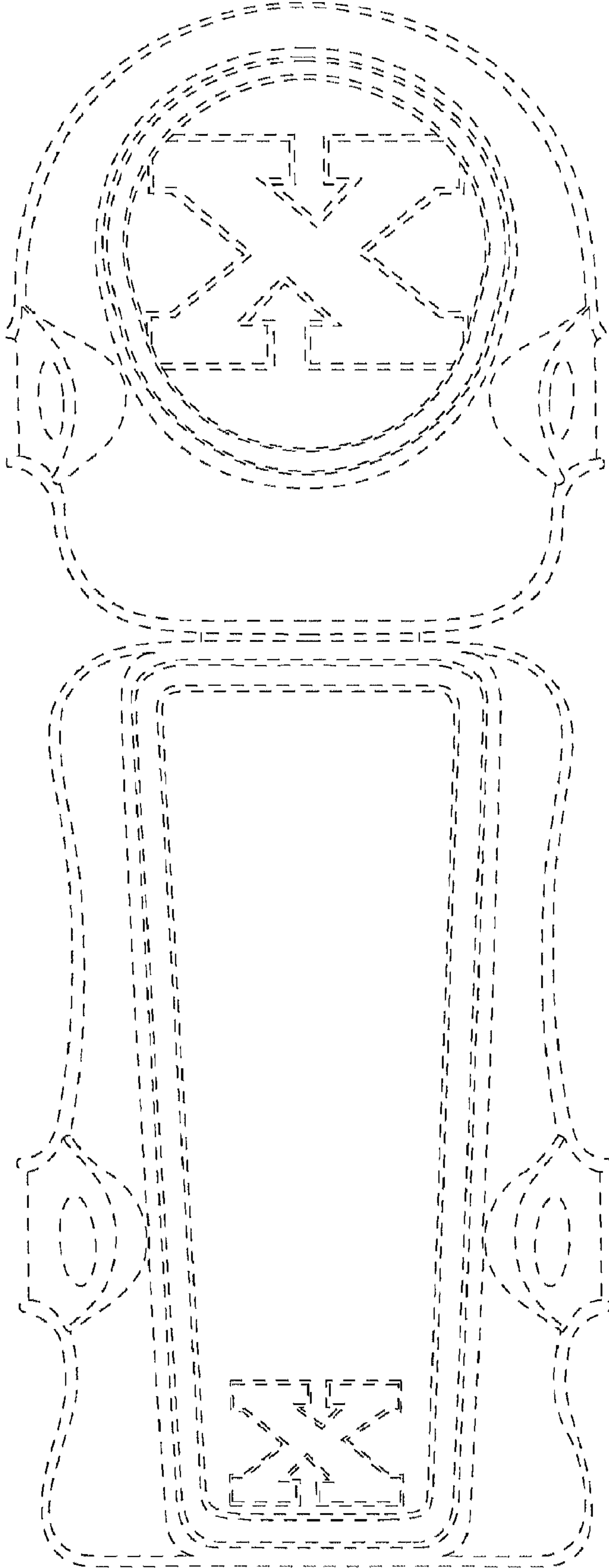
**DESCRIPTION**

FIG. 1 is a front view of a knee and shin protector, showing my design;  
 FIG. 2 is a rear view thereof;  
 FIG. 3 is a right side view thereof;  
 FIG. 4 is a left side view thereof;  
 FIG. 5 is a top view thereof;  
 FIG. 6 is a bottom view thereof;  
 FIG. 7 is a front view of the knee portion of the knee and shin protector of FIG. 1;  
 FIG. 8 is a rear view thereof;  
 FIG. 9 is a right side view thereof;  
 FIG. 10 is a left side view thereof;  
 FIG. 11 is a top view thereof;  
 FIG. 12 is a bottom view thereof;  
 FIG. 13 is a front view of the shin portion of the knee and shin protector of FIG. 1;  
 FIG. 14 is a rear view thereof;  
 FIG. 15 is a right side view thereof;  
 FIG. 16 is a left side view thereof; FIG. 17 is a top view thereof; and,  
 FIG. 18 is a bottom view thereof.

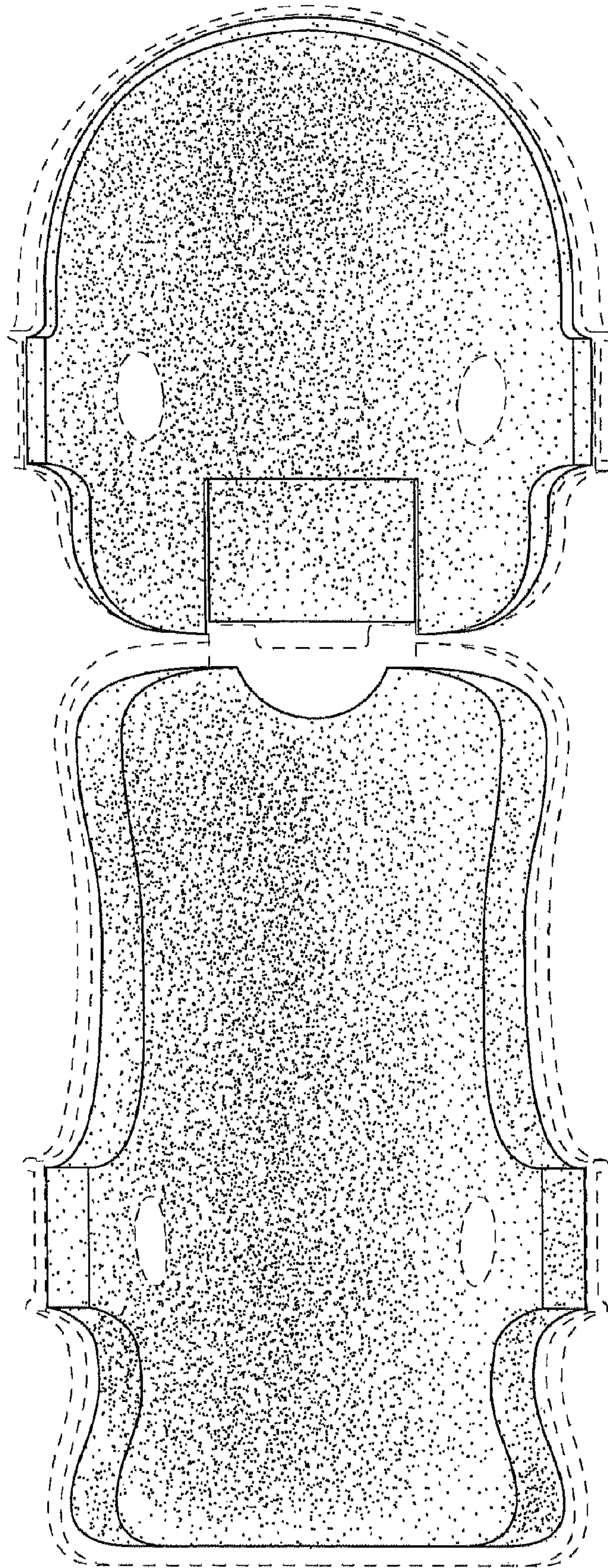
The knee and shin portions of the knee and shin protector are shown separately for ease of illustration.  
 The broken line showing of portions of the knee and shin protector forms no part of the claimed design.

**1 Claim, 12 Drawing Sheets**

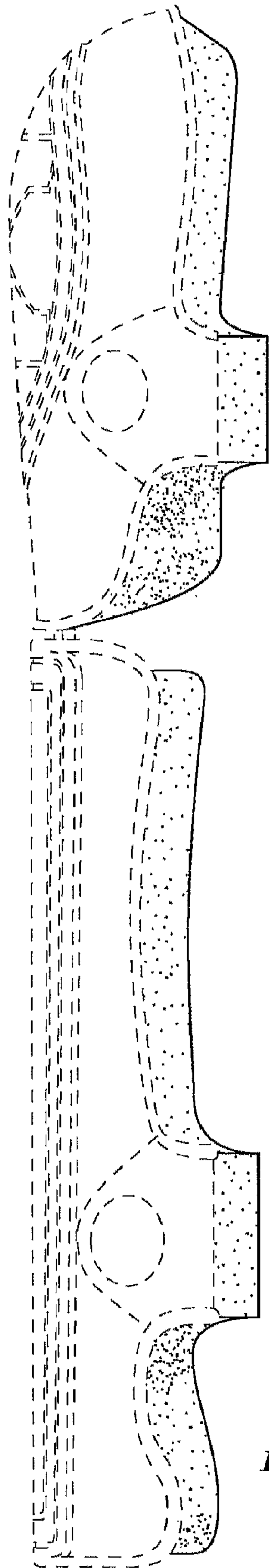




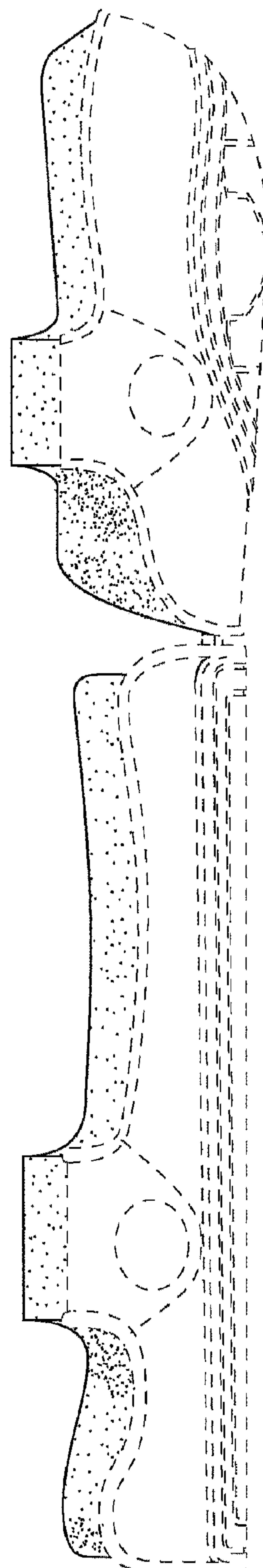
**Fig. 1**



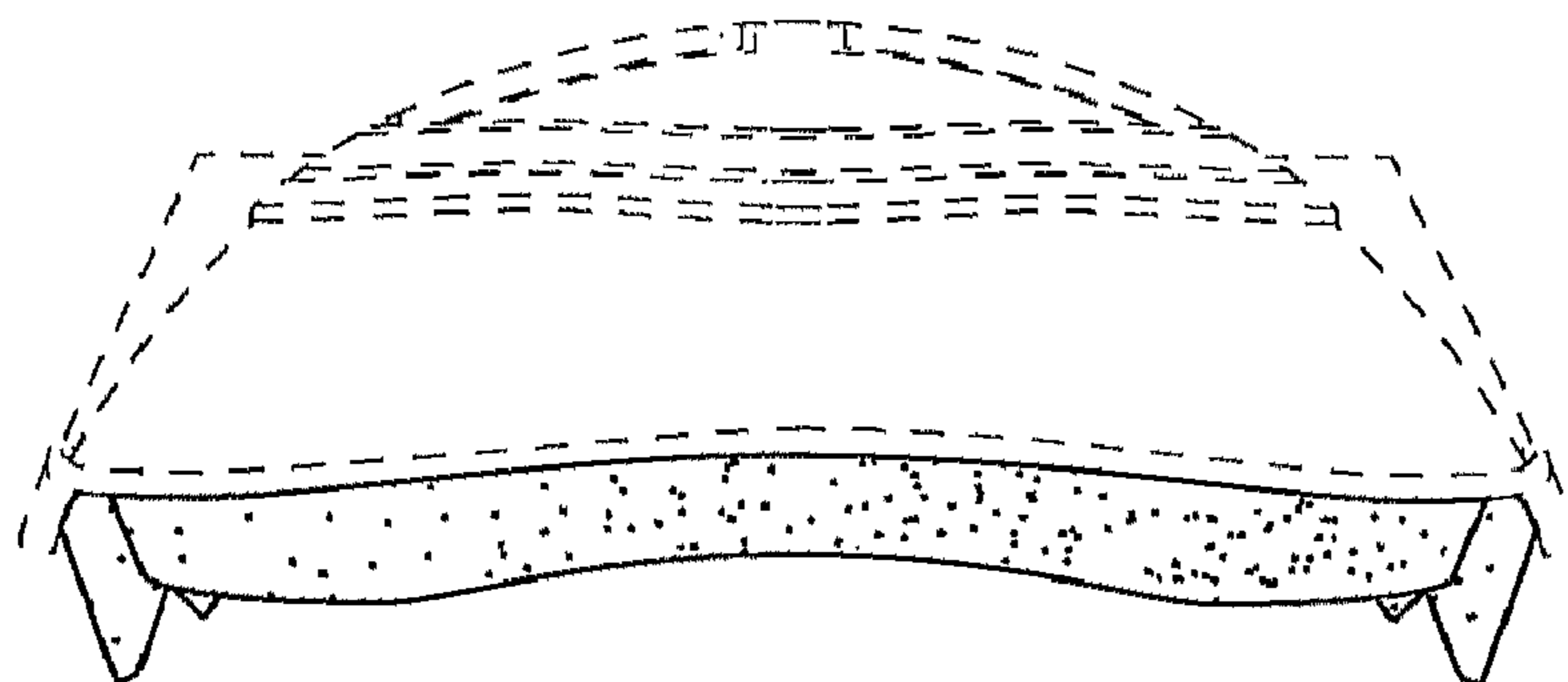
*Fig. 2*



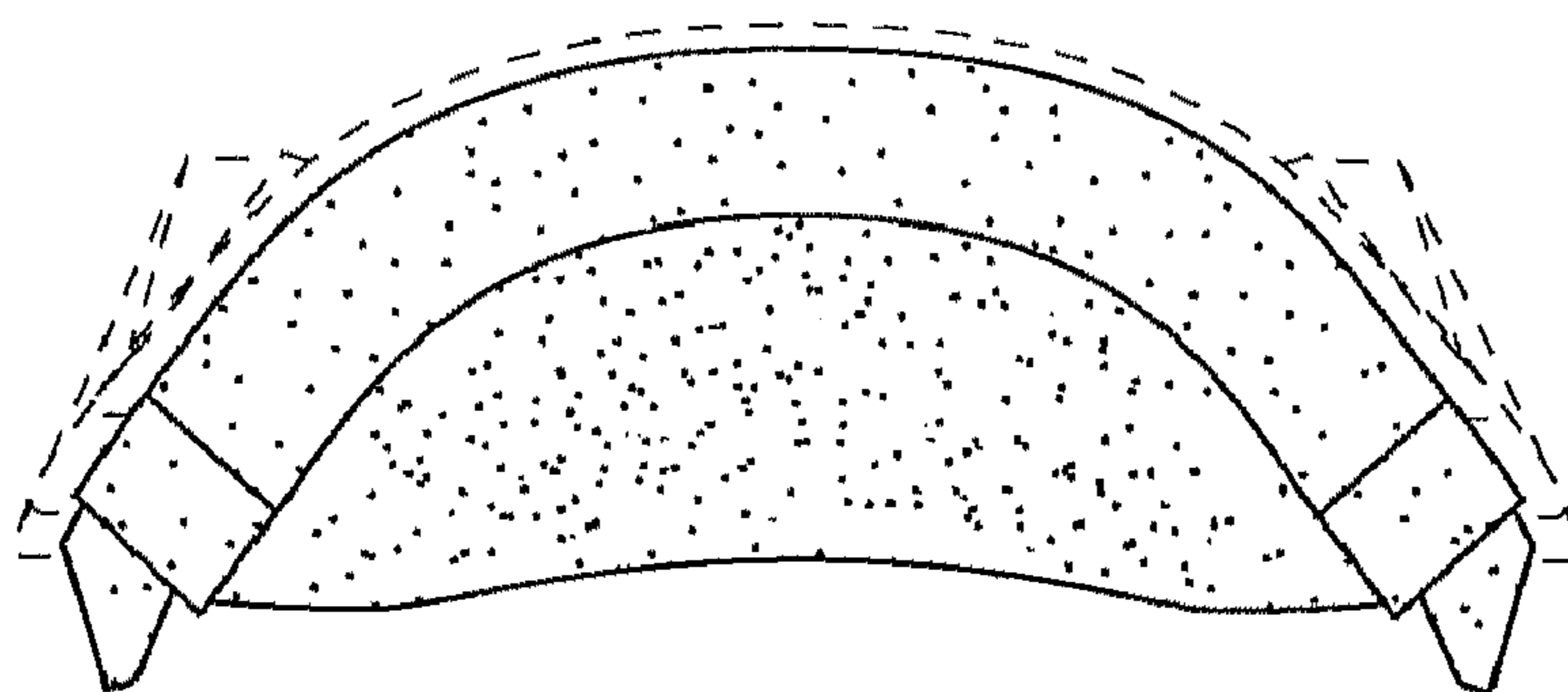
*Fig. 3*



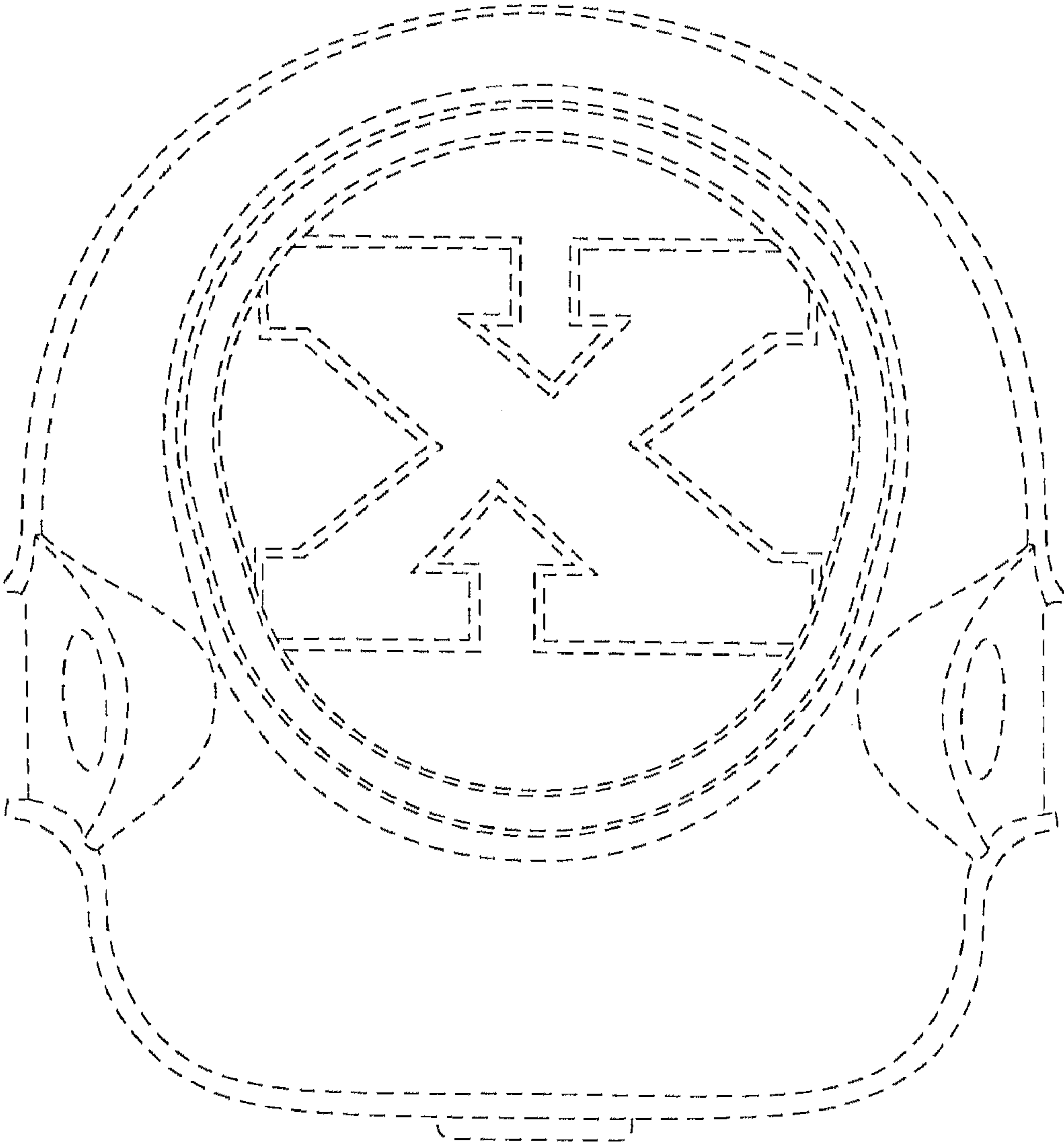
*Fig. 4*



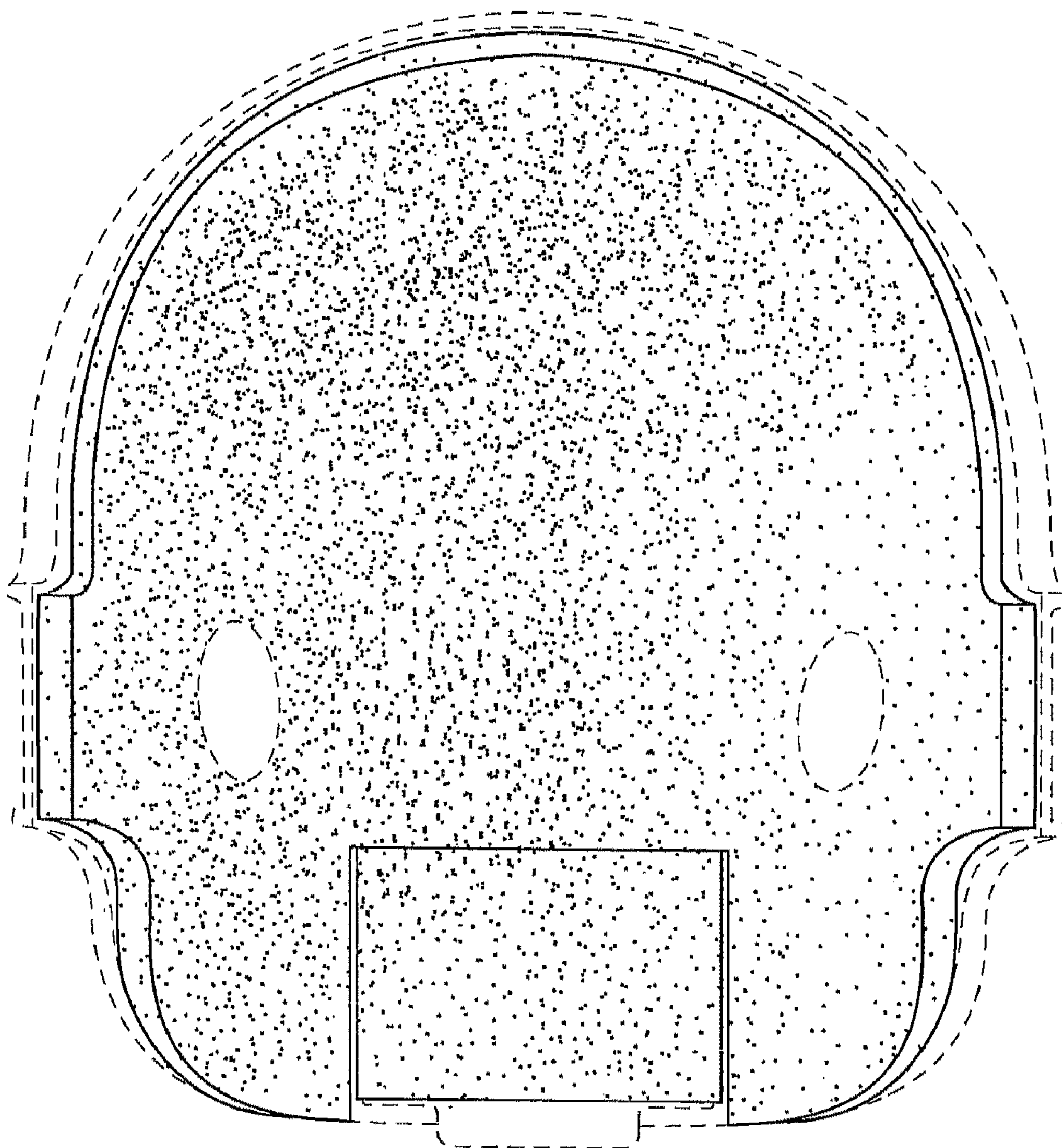
*Fig. 5*



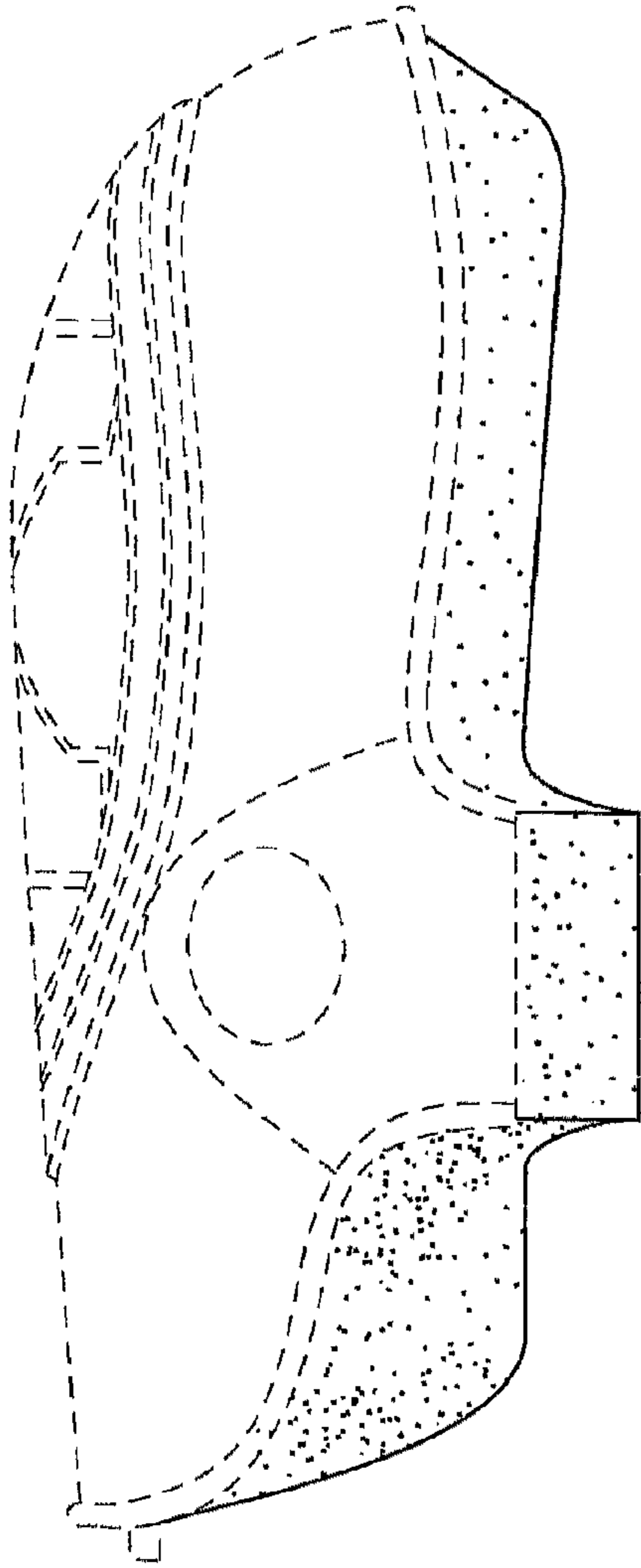
*Fig. 6*



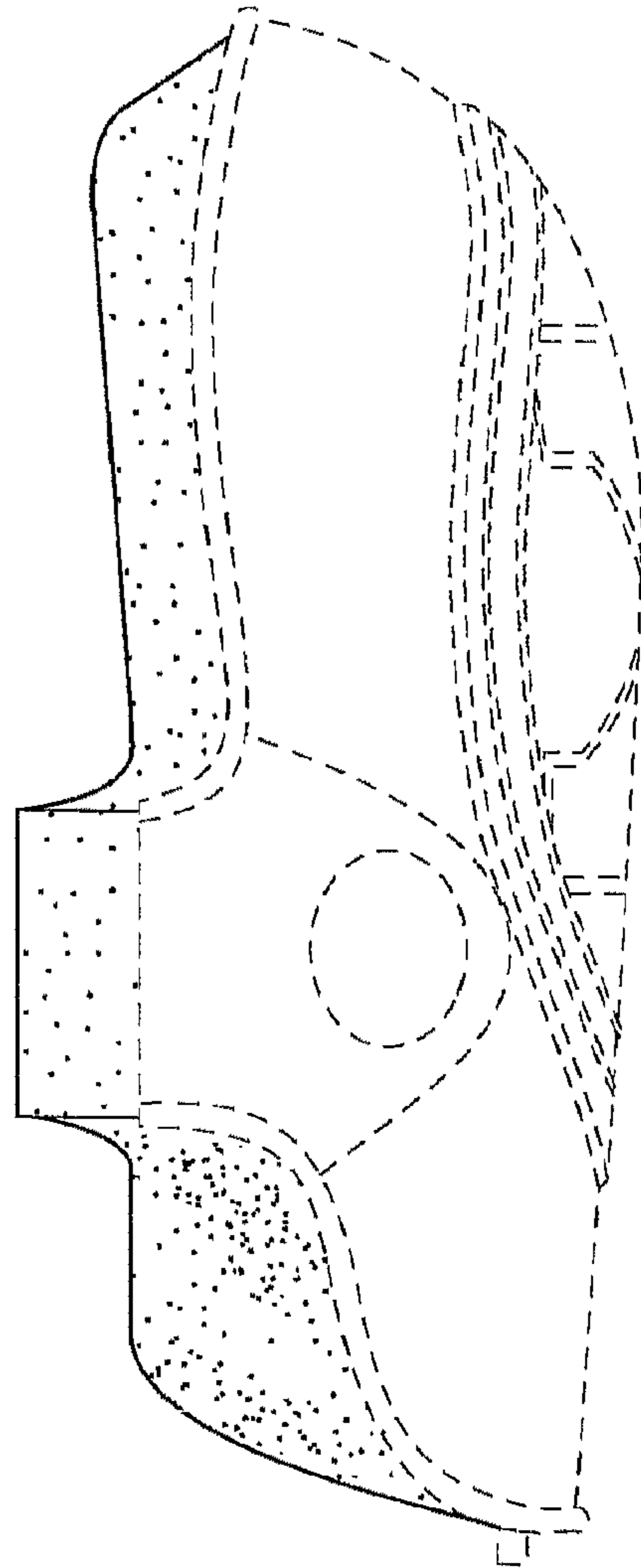
**Fig. 7**



*Fig. 8*

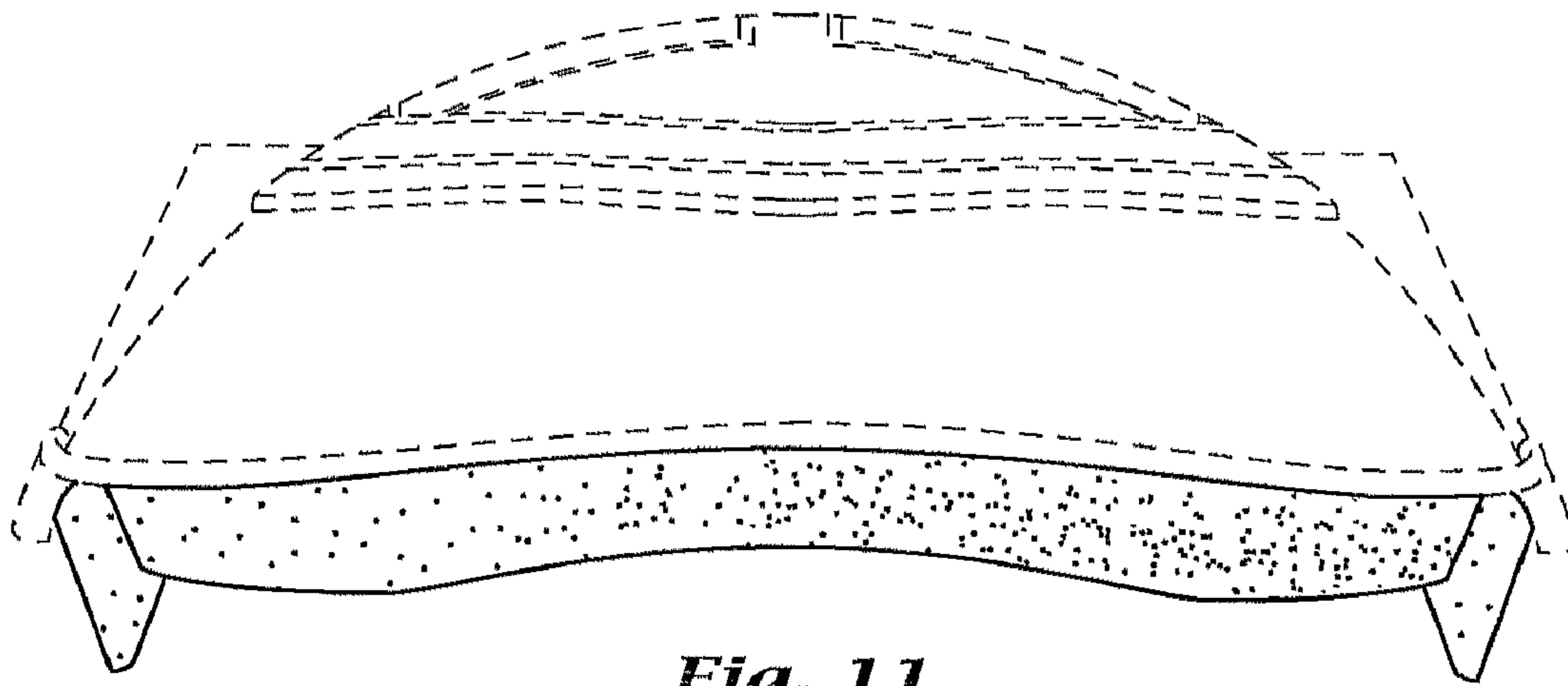


**Fig. 9**

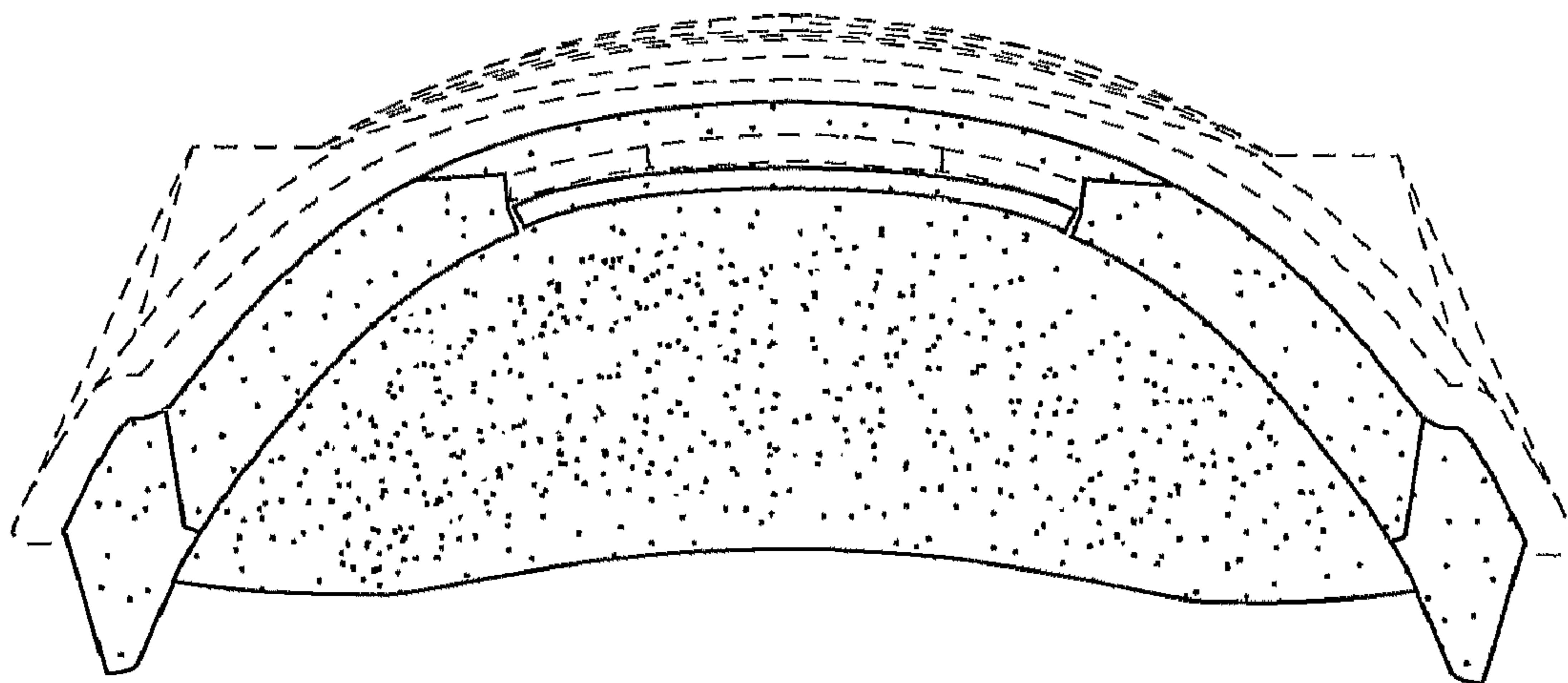


**Fig. 10**

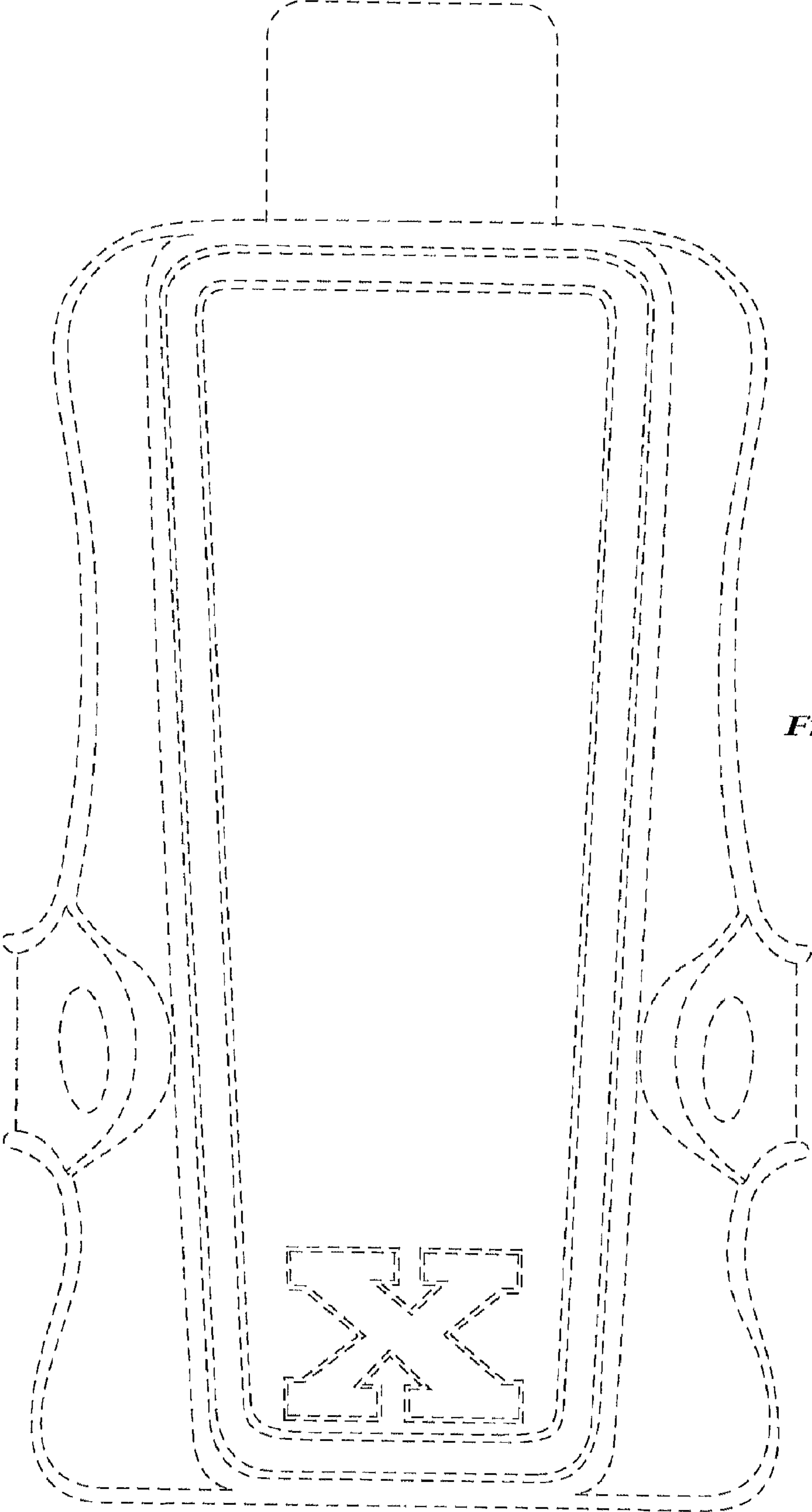




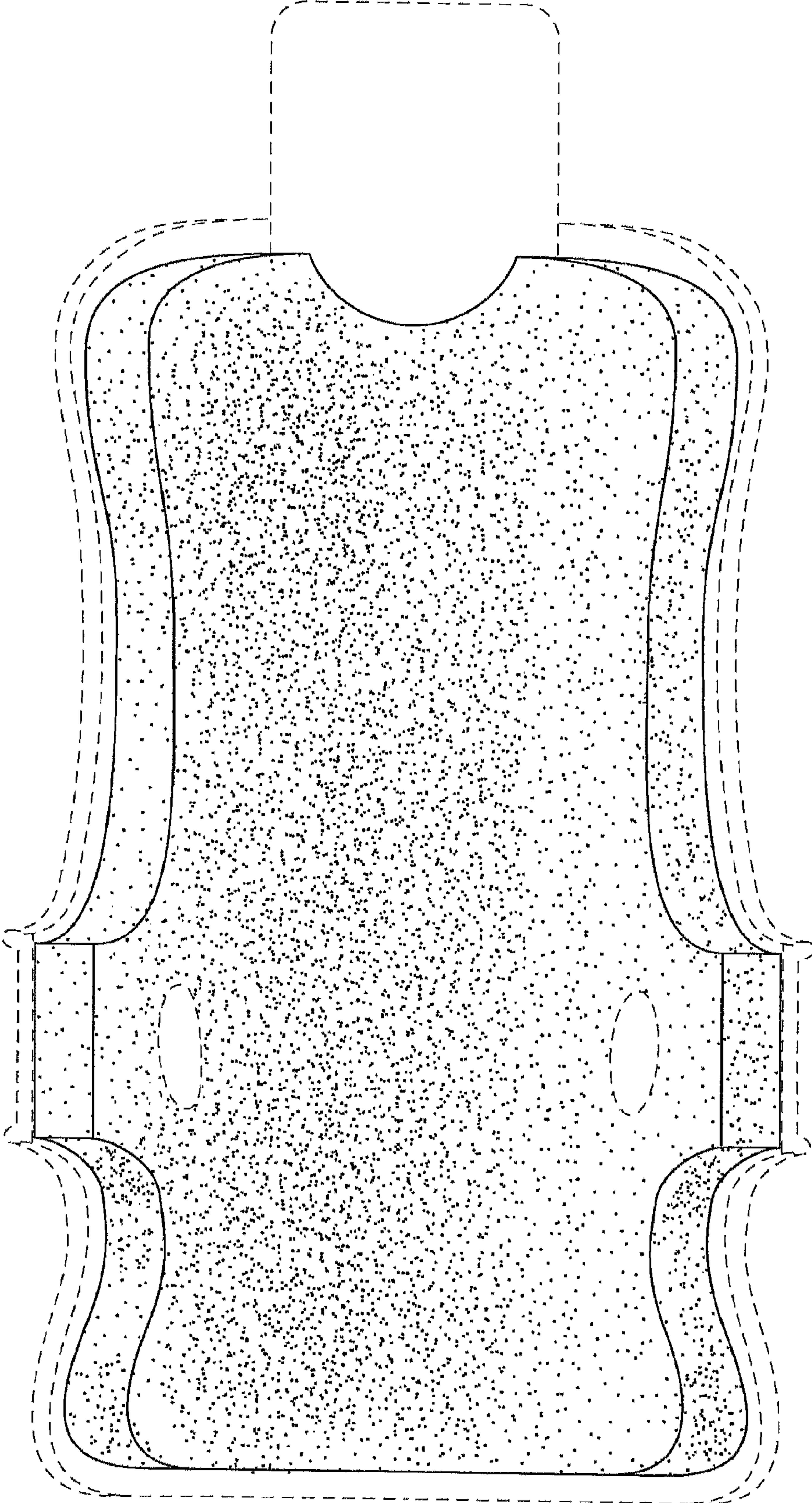
*Fig. 11*



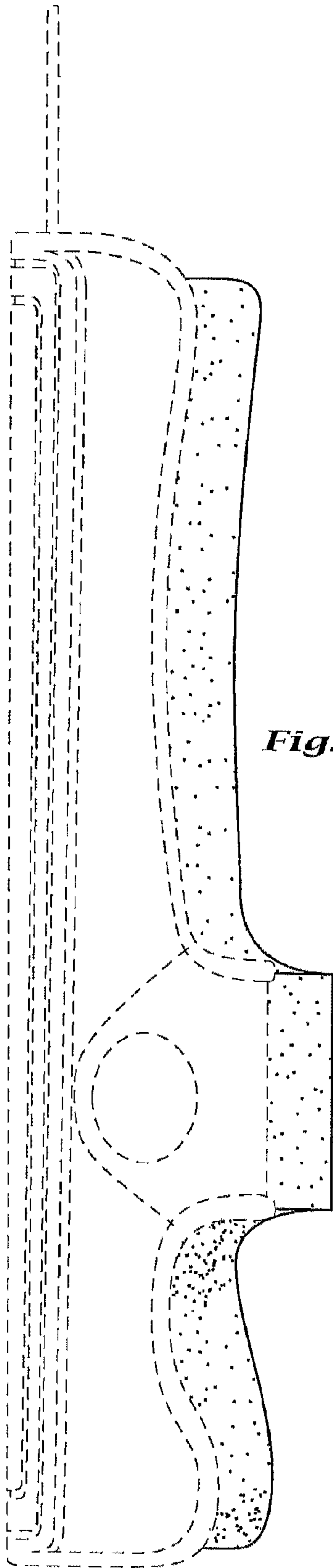
*Fig. 12*



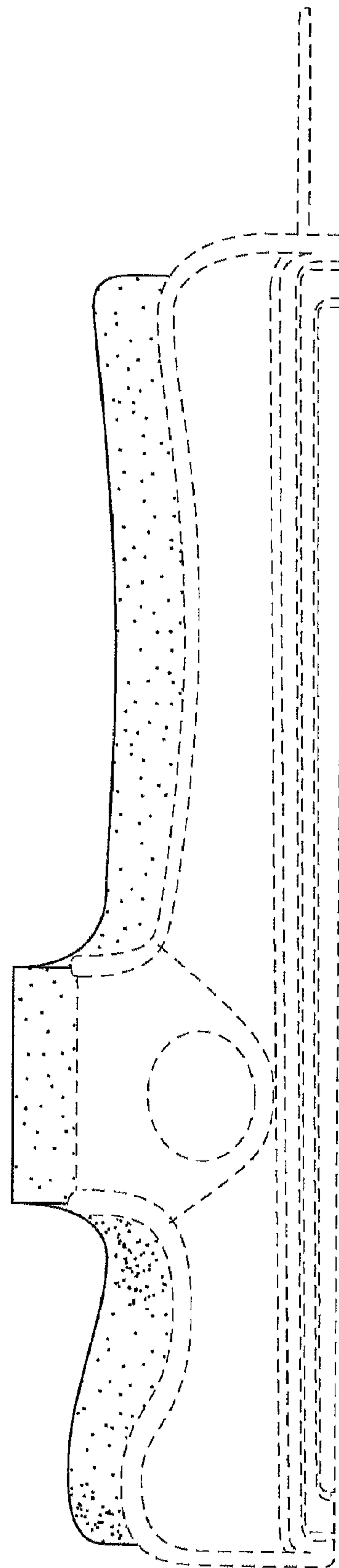
*Fig. 13*



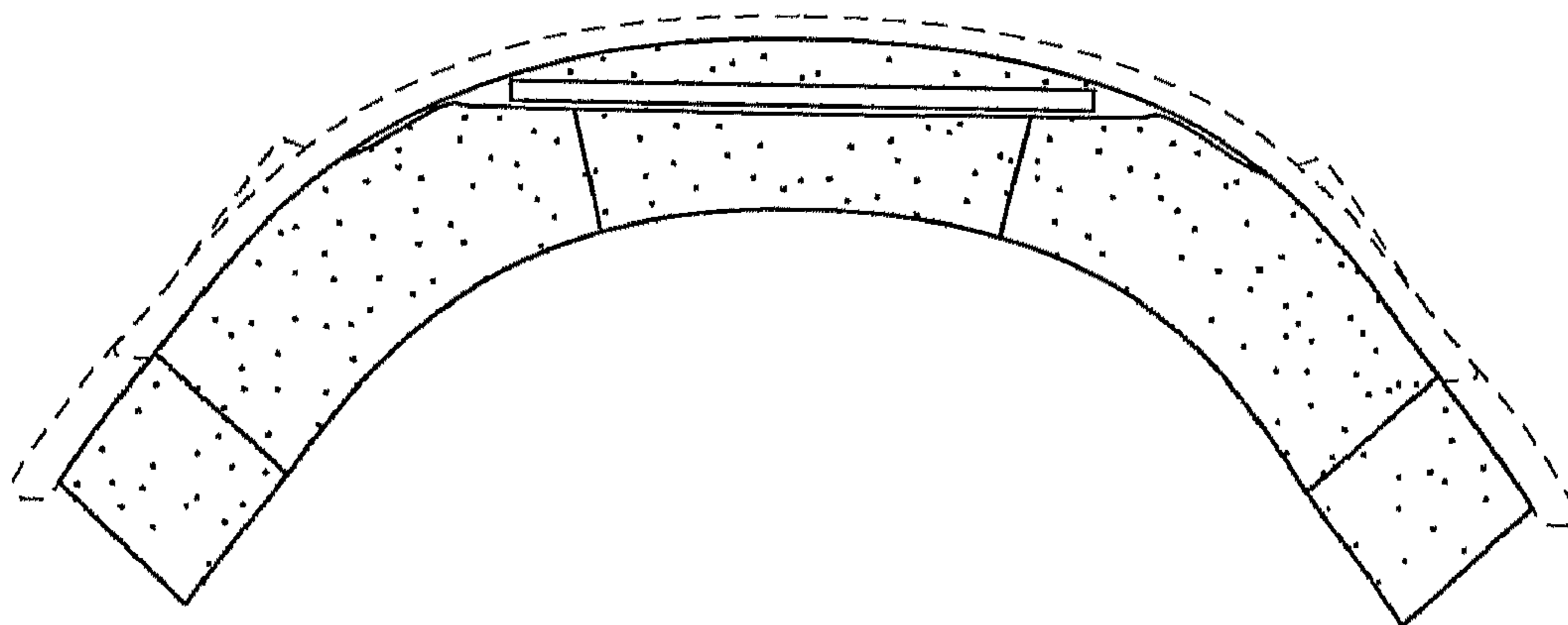
*Fig. 14*



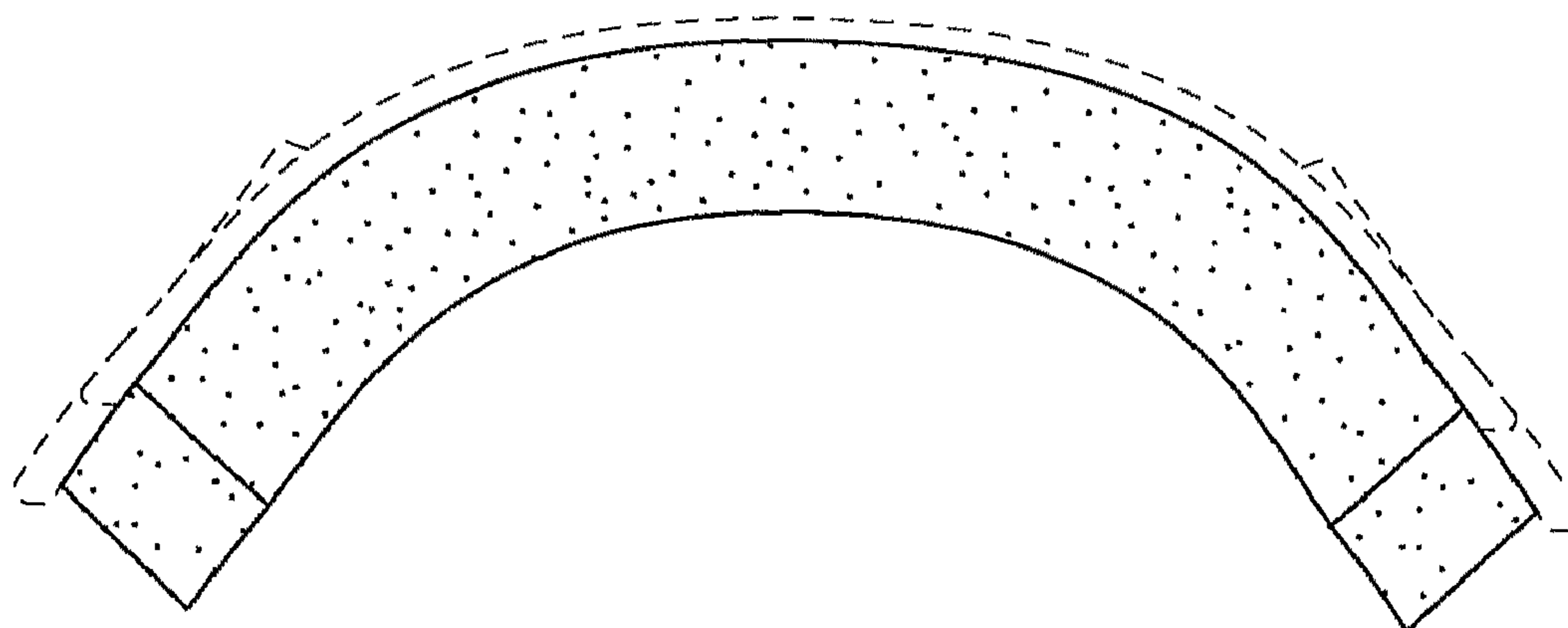
*Fig. 15*



*Fig. 16*



*Fig. 17*



*Fig. 18*