



US00D661805S

(12) **United States Design Patent**  
**Detry**

(10) **Patent No.:** **US D661,805 S**  
(45) **Date of Patent:** **\*\* Jun. 12, 2012**

(54) **SURGICAL INSTRUMENT**

(75) Inventor: **Marc Detry**, Ayze (FR)

(73) Assignee: **Zimmer Surgical SA**, Plan-les-Ouates (CH)

(\*\*) Term: **14 Years**

(21) Appl. No.: **29/399,447**

(22) Filed: **Aug. 15, 2011**

(51) **LOC (9) Cl.** ..... **24-02**

(52) **U.S. Cl.** ..... **D24/146**

(58) **Field of Classification Search** ..... D24/146,  
D24/147; D8/20, 26, 64; 606/79, 82, 167,  
606/176-178; 30/338, 339, 392  
See application file for complete search history.

(56) **References Cited**

**U.S. PATENT DOCUMENTS**

1,429,162	A *	9/1922	Oberlander	30/151
3,899,828	A *	8/1975	Bosco	30/151
4,558,517	A *	12/1985	Gringer	30/169
4,584,999	A *	4/1986	Arnegger	606/178
4,922,614	A *	5/1990	Machida	30/339
5,382,249	A *	1/1995	Fletcher	606/79
5,433,004	A *	7/1995	Thompson et al.	30/169
5,916,218	A *	6/1999	Hagen et al.	606/82
6,503,253	B1 *	1/2003	Fletcher et al.	606/79
6,684,481	B2 *	2/2004	Kullmer	29/558
6,775,912	B2 *	8/2004	Panfili et al.	30/169
D586,512	S *	2/2009	van Deursen	D32/46
D601,869	S *	10/2009	Nelson	D8/20
7,901,424	B2 *	3/2011	Fletcher et al.	606/176
D642,264	S *	7/2011	Fisher et al.	D24/146

D654,590	S *	2/2012	Fisher et al.	D24/146
2004/0199167	A1 *	10/2004	Fletcher et al.	606/79
2007/0169353	A1 *	7/2007	Wu	30/155

\* cited by examiner

*Primary Examiner* — Ian Simmons

*Assistant Examiner* — Carissa C Fitts

(74) *Attorney, Agent, or Firm* — Cermak Nakajima LLP;  
Adam J. Cermak

(57) **CLAIM**

The ornamental design for a surgical instrument, as shown and described.

**DESCRIPTION**

FIG. 1 is a top, rear, left perspective views of a surgical instrument, showing my new design;

FIG. 2 is a top plan view of the surgical instrument shown in FIG. 1;

FIG. 3 is a front side elevational view of the surgical instrument shown in FIG. 1;

FIG. 4 is a right elevational view of the surgical instrument shown in FIG. 1;

FIG. 5 is a left side elevational view of the surgical instrument shown in FIG. 1;

FIG. 6 is a rear side elevational view of the surgical instrument shown in FIG. 1; and,

FIG. 7 is a bottom plan view of the surgical instrument shown in FIG. 1.

The broken line showing in FIGS. 1-3 are for environmental purposes only and forms no part of the claimed design.

**1 Claim, 5 Drawing Sheets**

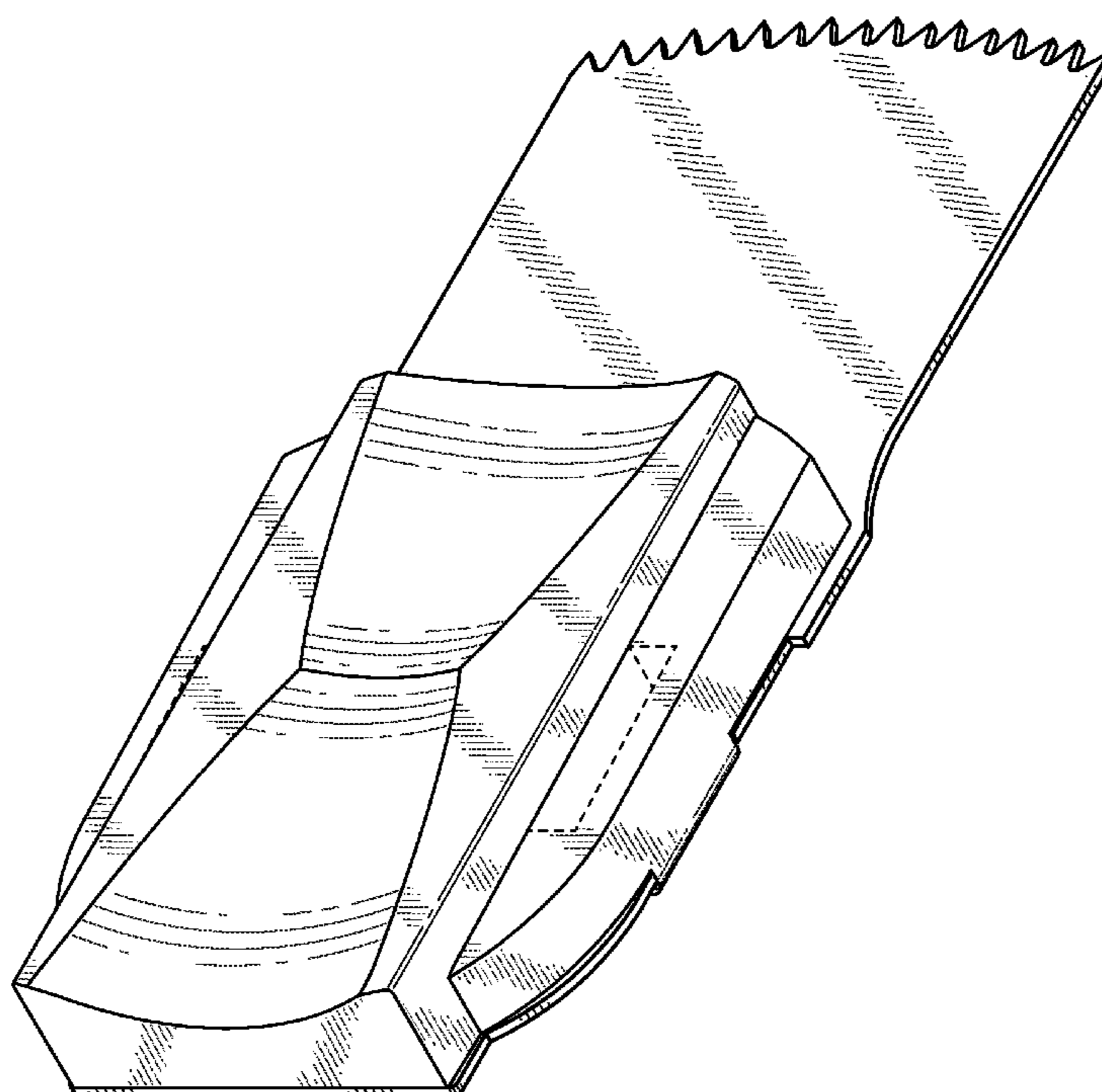

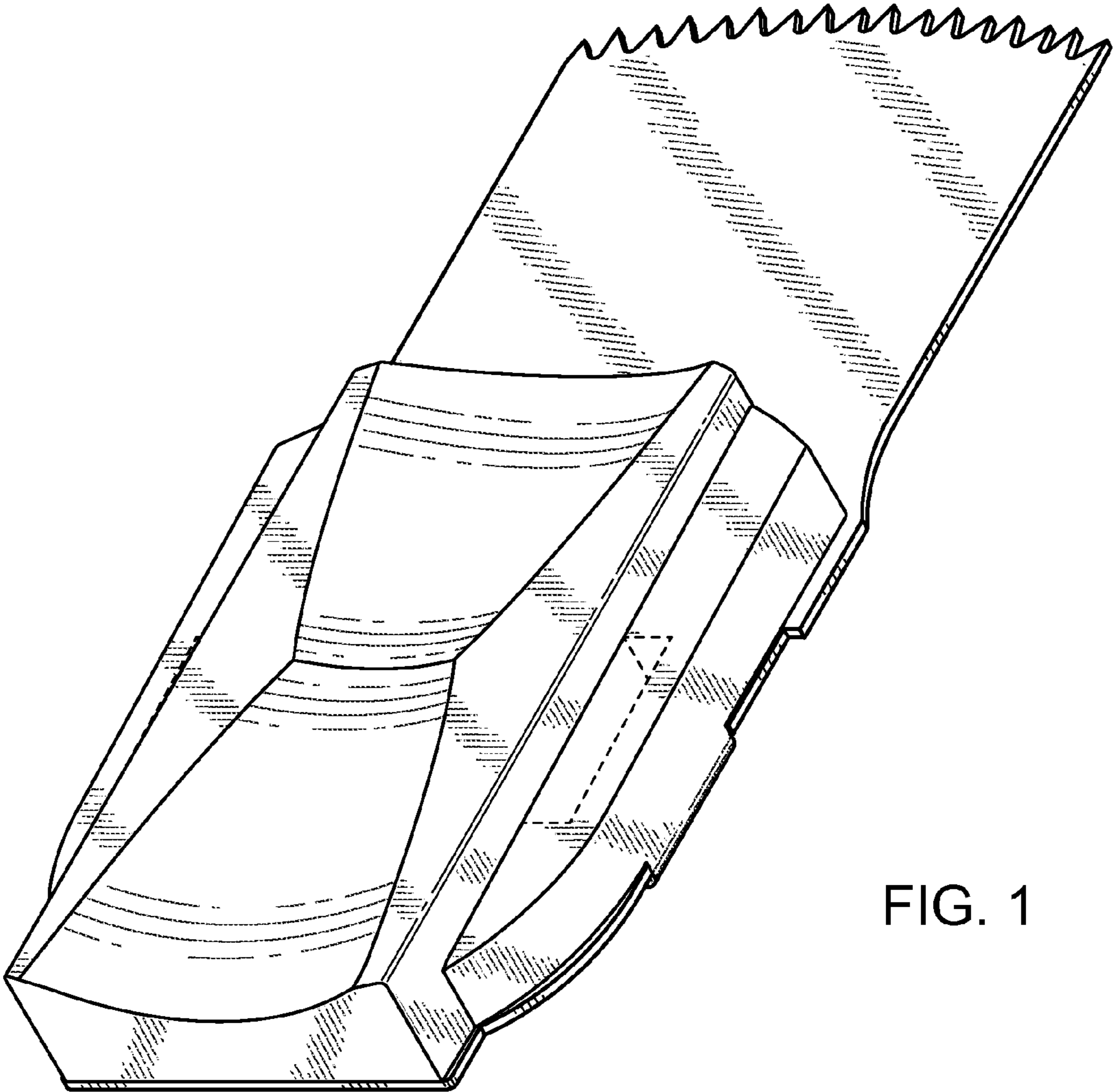

FIG. 1

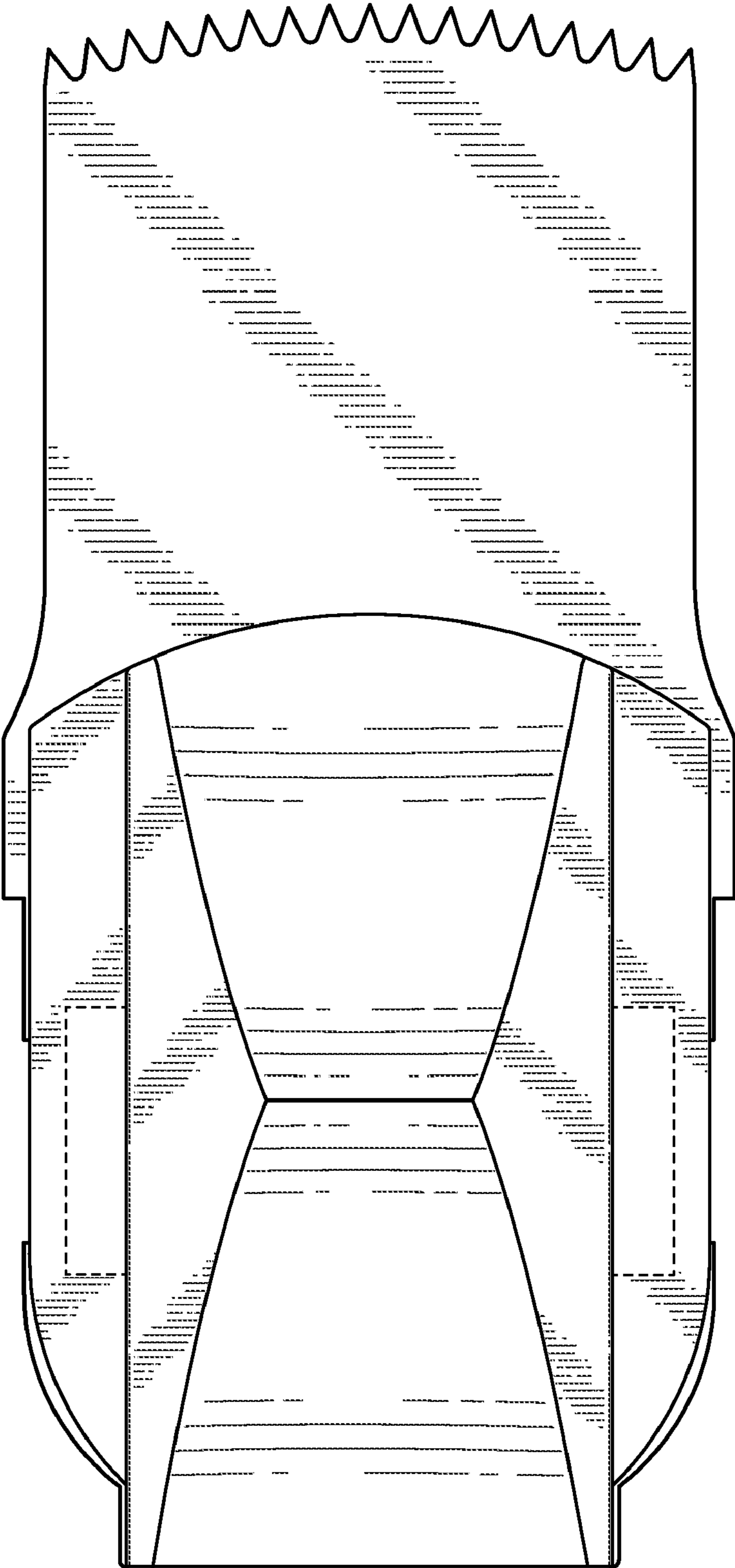

FIG. 2

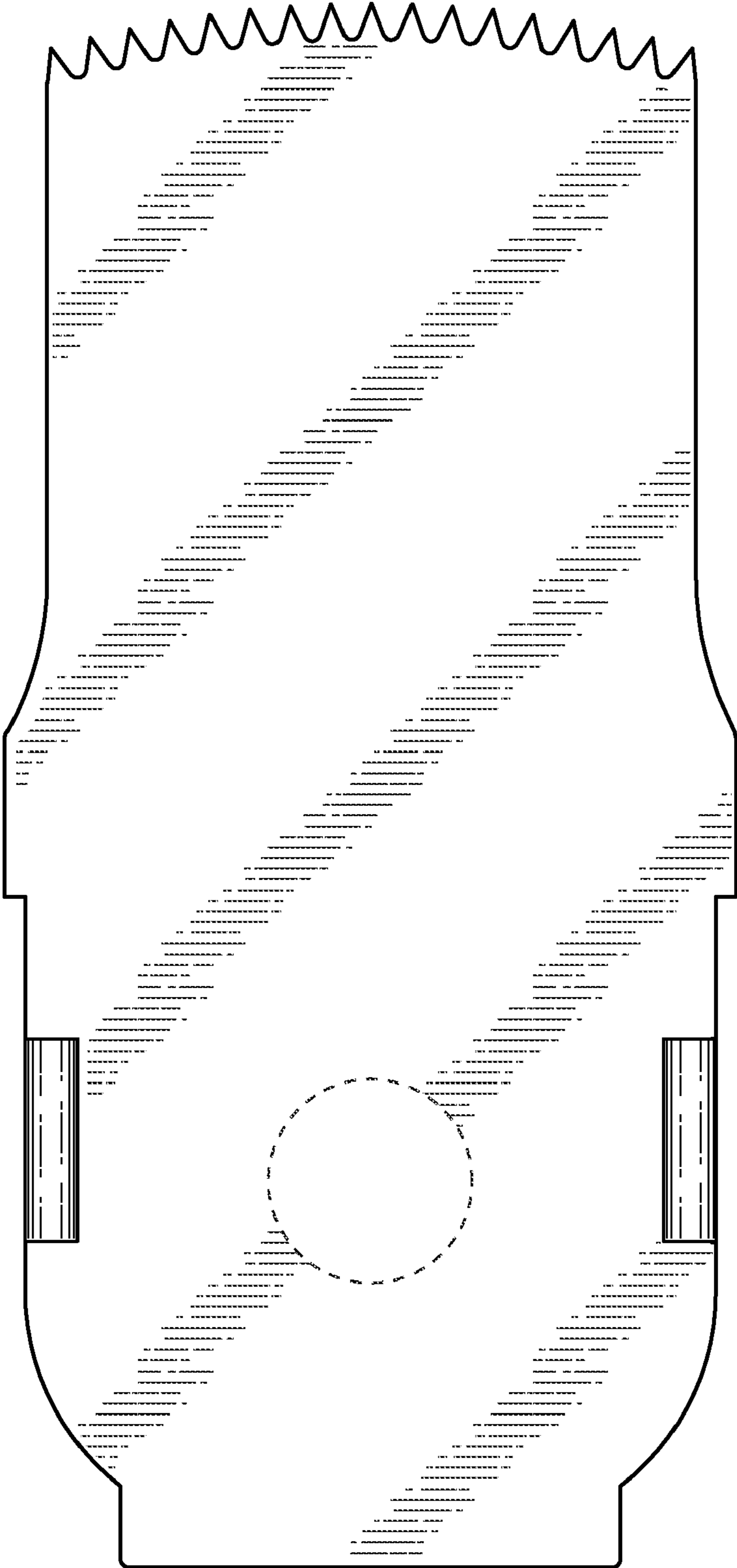

FIG. 3

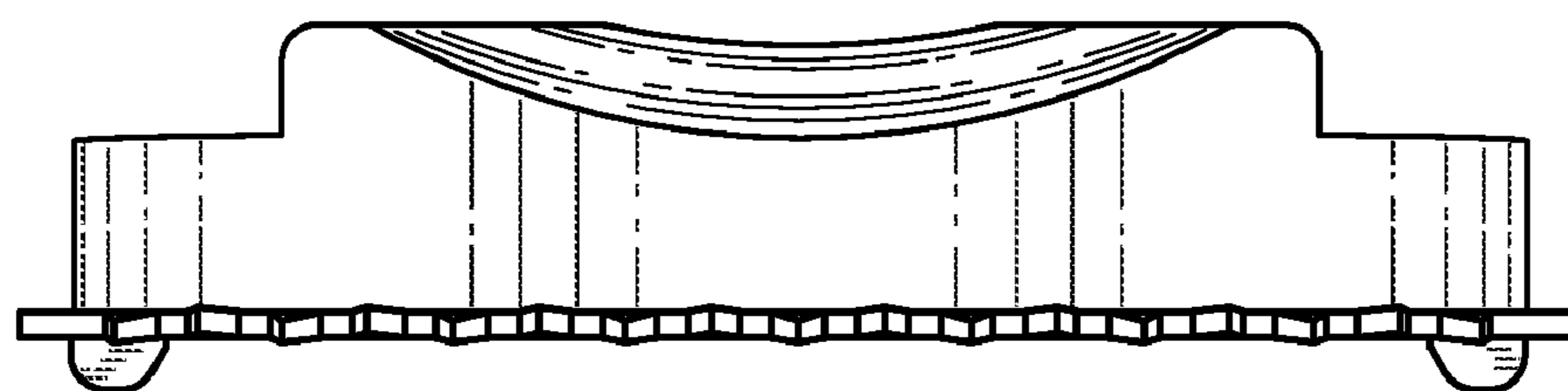

FIG. 4

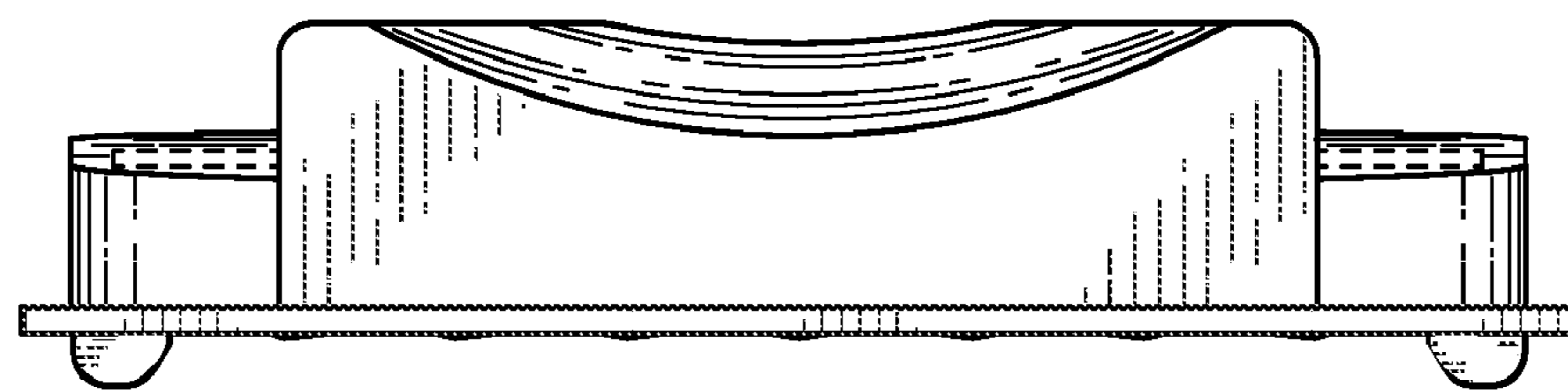

FIG. 5

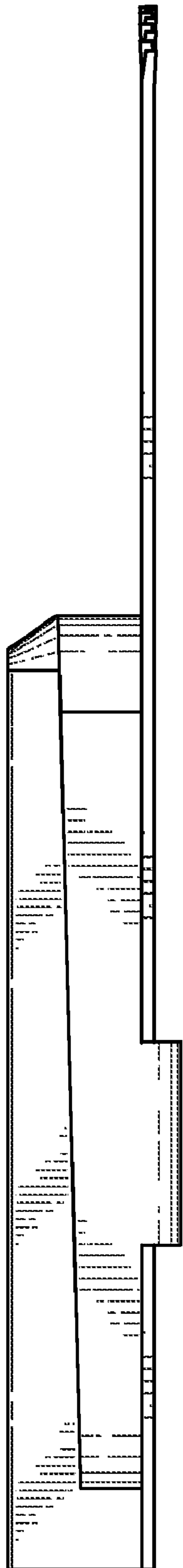

FIG. 6

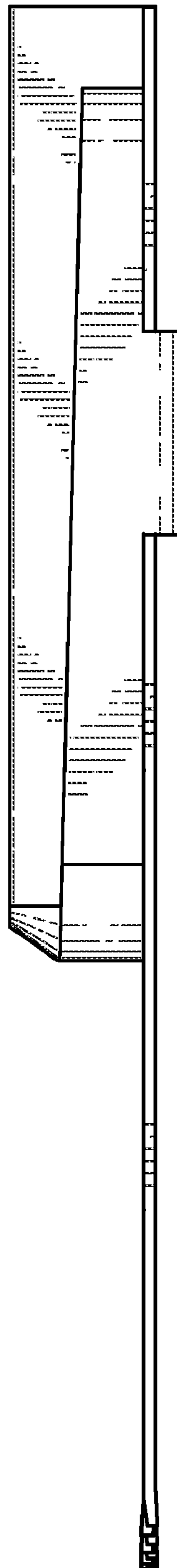

FIG. 7