

US00D661708S

(12) **United States Design Patent**  
**Bender**

(10) **Patent No.:** **US D661,708 S**  
(45) **Date of Patent:** **\*\* Jun. 12, 2012**

(54) **COLD AIR INLET TUBE**

(75) Inventor: **Lee F. Bender**, Huntsville, AL (US)

(73) Assignee: **C&L Performance, Inc.**, Huntsville, AL (US)

(\*\*) Term: **14 Years**

(21) Appl. No.: **29/376,132**

(22) Filed: **Oct. 1, 2010**

(51) **LOC (9) Cl.** ..... **15-01**

(52) **U.S. Cl.** ..... **D15/5**

(58) **Field of Classification Search** ..... D15/1-5;  
D12/194, 400; 123/184.21, 198 E, 184.29,  
123/184.46

See application file for complete search history.

(56) **References Cited**

U.S. PATENT DOCUMENTS

6,886,526 B2 \* 5/2005 Bishop ..... 123/198 E  
D513,618 S \* 1/2006 Bender ..... D15/5  
D514,591 S \* 2/2006 Bender ..... D15/5

D533,189 S \* 12/2006 Bender ..... D15/5  
D533,191 S \* 12/2006 Bender ..... D15/5  
2008/0041328 A1 \* 2/2008 Granatelli ..... 123/184.21

\* cited by examiner

*Primary Examiner* — T. Chase Nelson

*Assistant Examiner* — Ania Aman

(74) *Attorney, Agent, or Firm* — George P. Kobler; Lanier Ford Shaver & Payne, P.C.

(57) **CLAIM**

The ornamental design for a cold air inlet tube, as shown and described.

**DESCRIPTION**

FIG. 1 is a rear perspective view of the cold air inlet tube; FIG. 2 is front perspective view of the cold air inlet tube; FIG. 3 is a rear elevational view of the cold air inlet tube; FIG. 4 is a right side elevational view of the cold air inlet tube; FIG. 5 is a front elevational view of the cold air inlet tube; FIG. 6 is a left side elevational view of the cold air inlet tube; FIG. 7 is a top plan view of the cold air inlet tube; and, FIG. 8 is a bottom plan view of the cold air inlet tube.

**1 Claim, 4 Drawing Sheets**

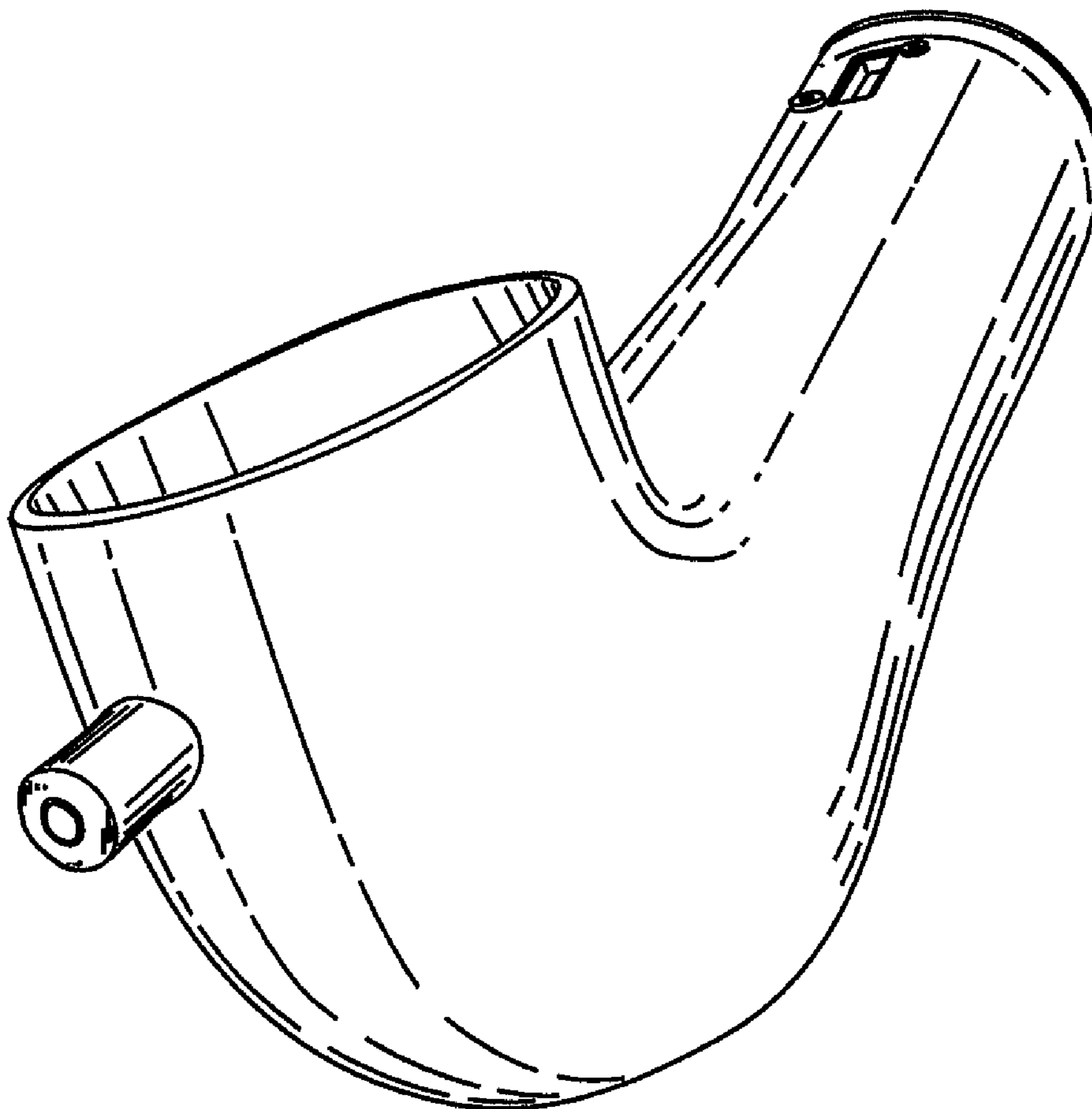

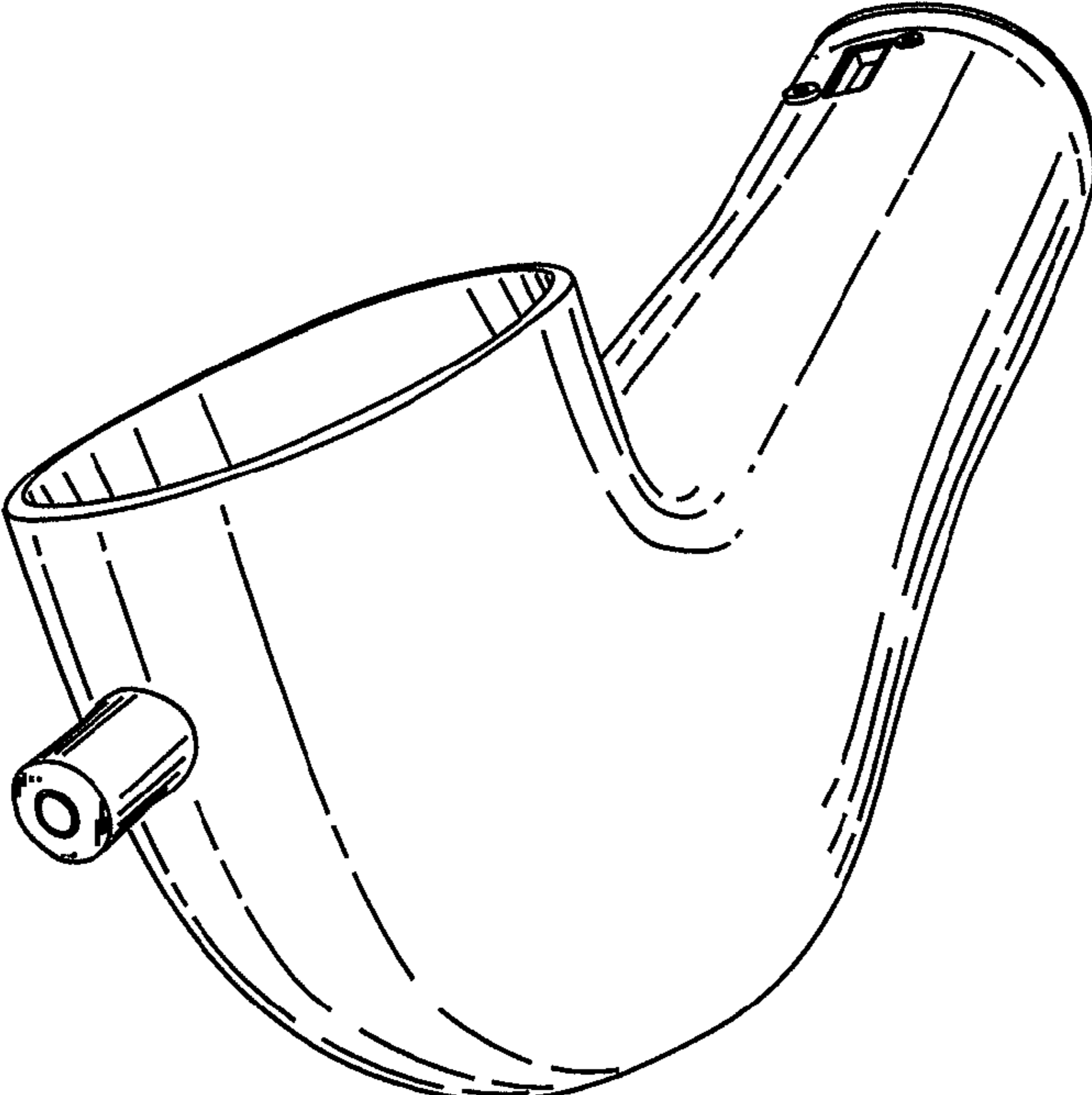

Fig 1

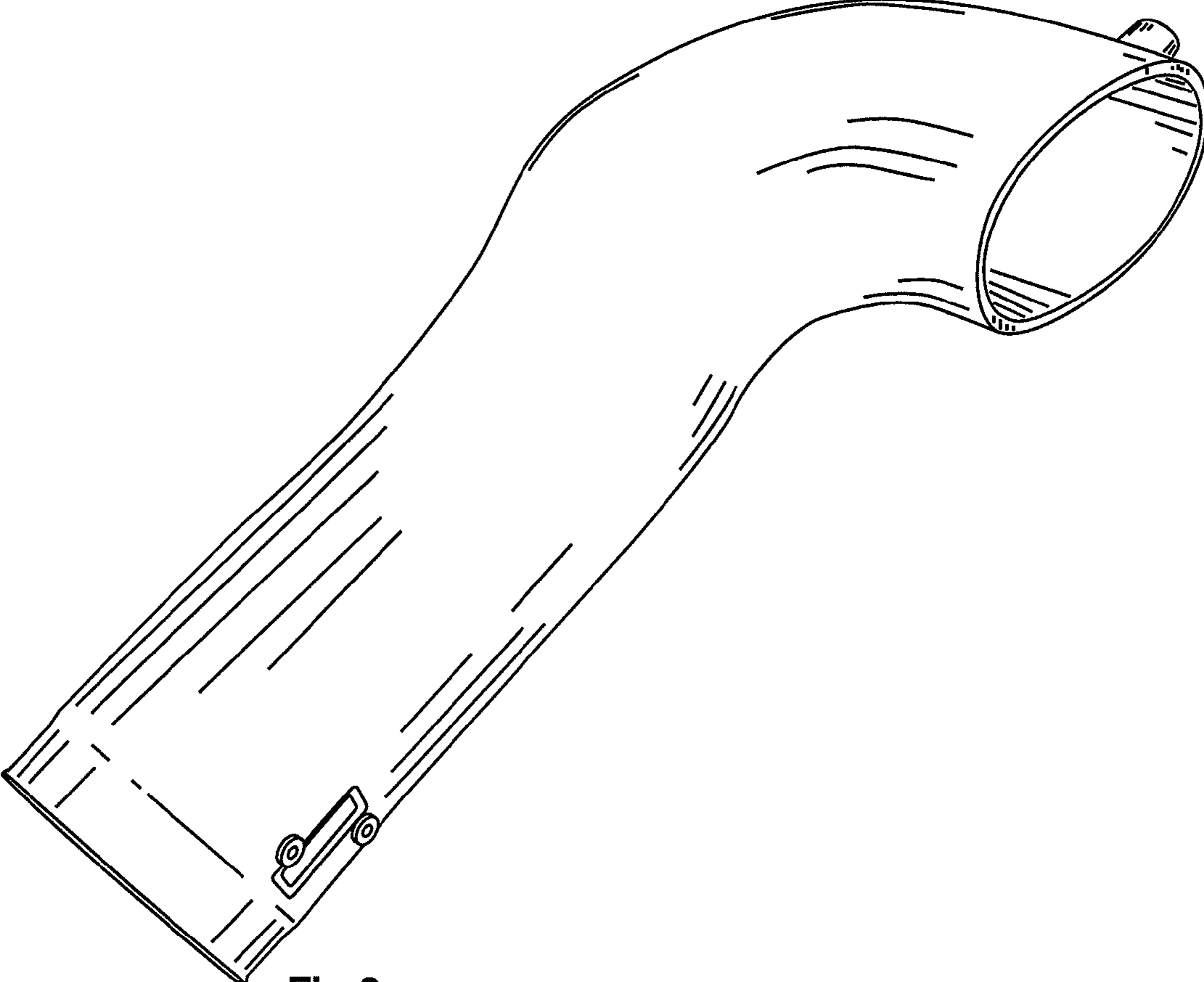

Fig 2

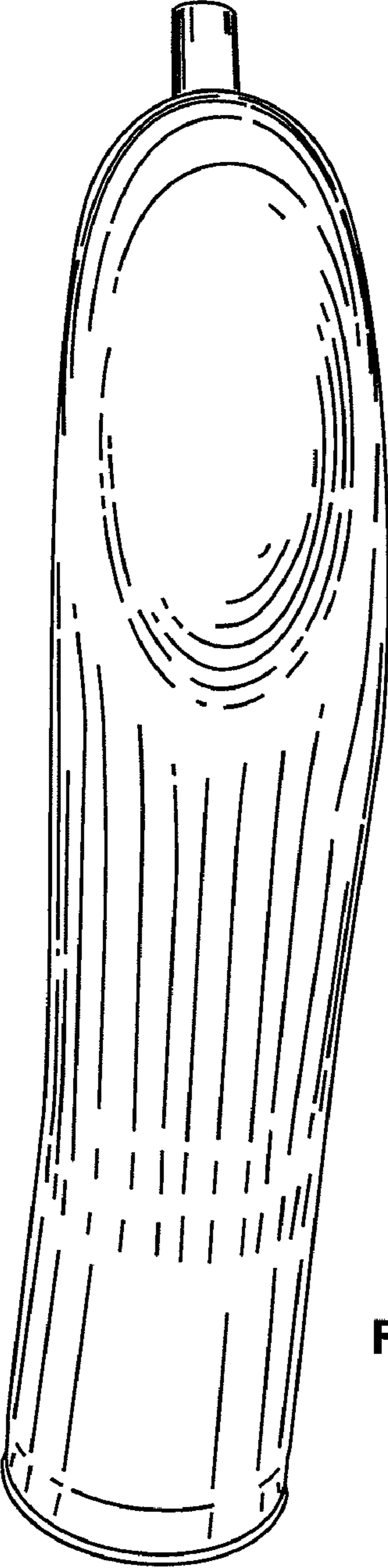

Fig 3

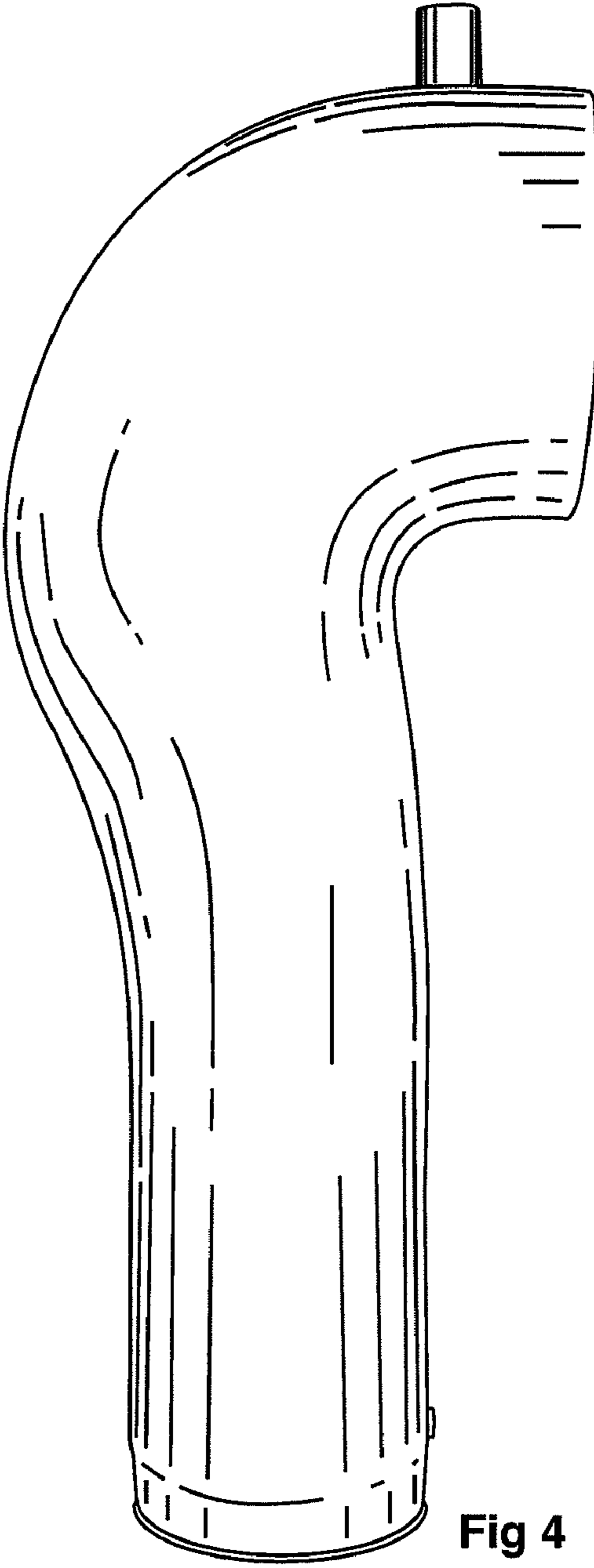

Fig 4

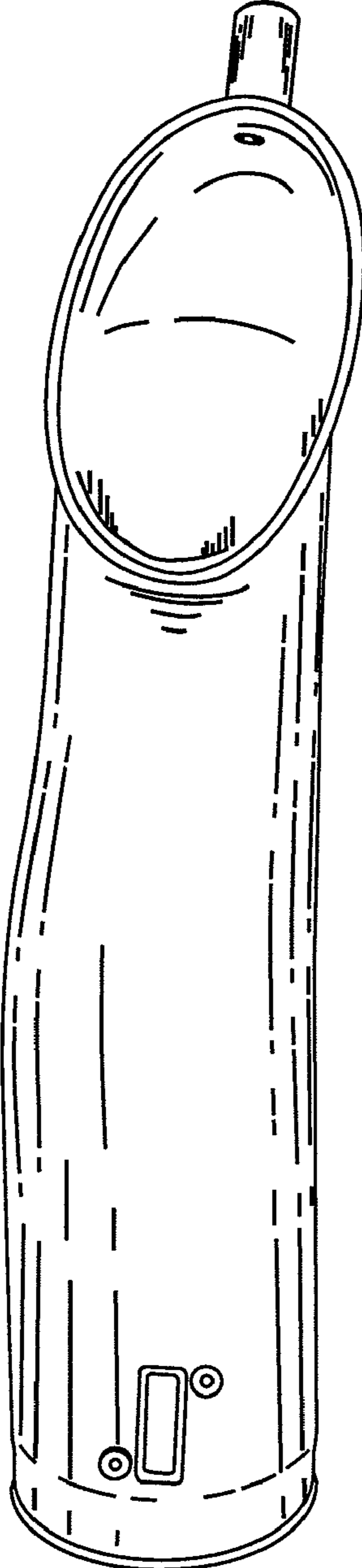

Fig 5

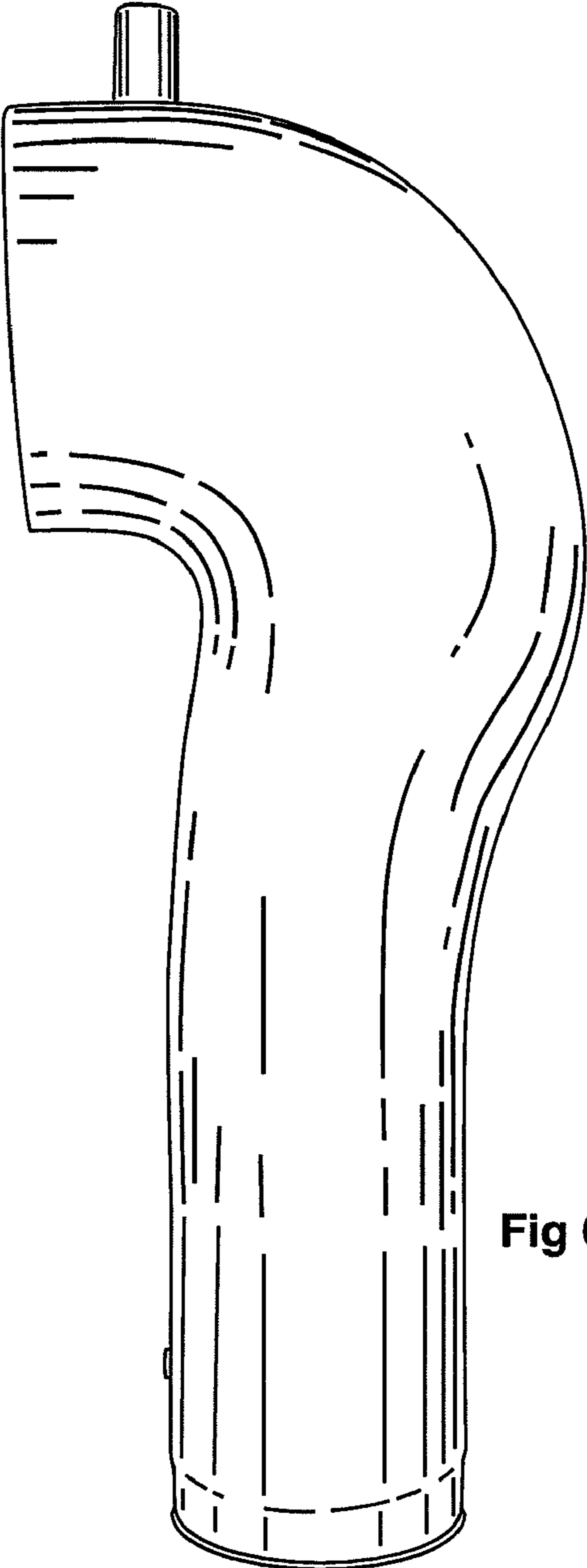

Fig 6

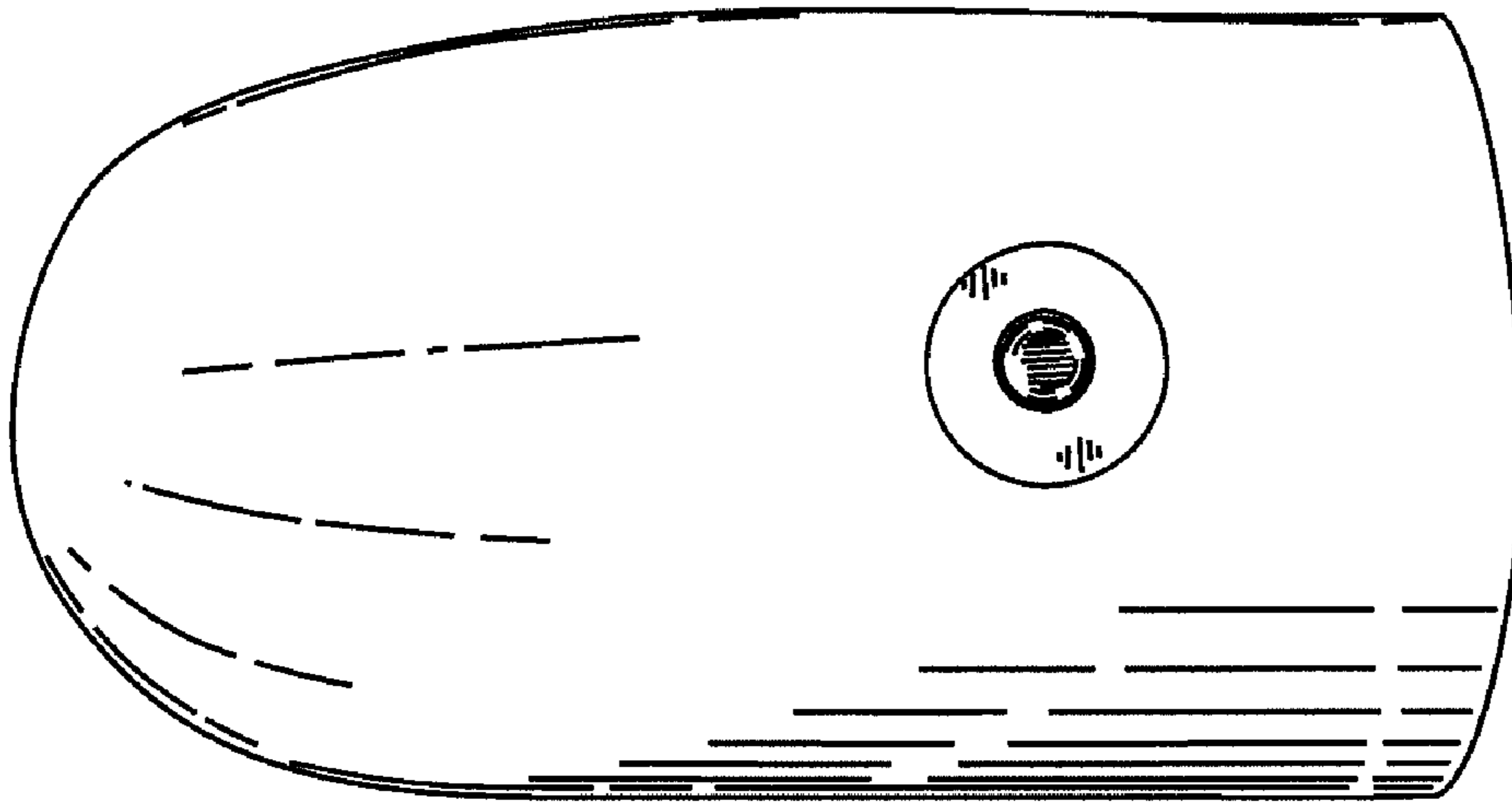

Fig 7

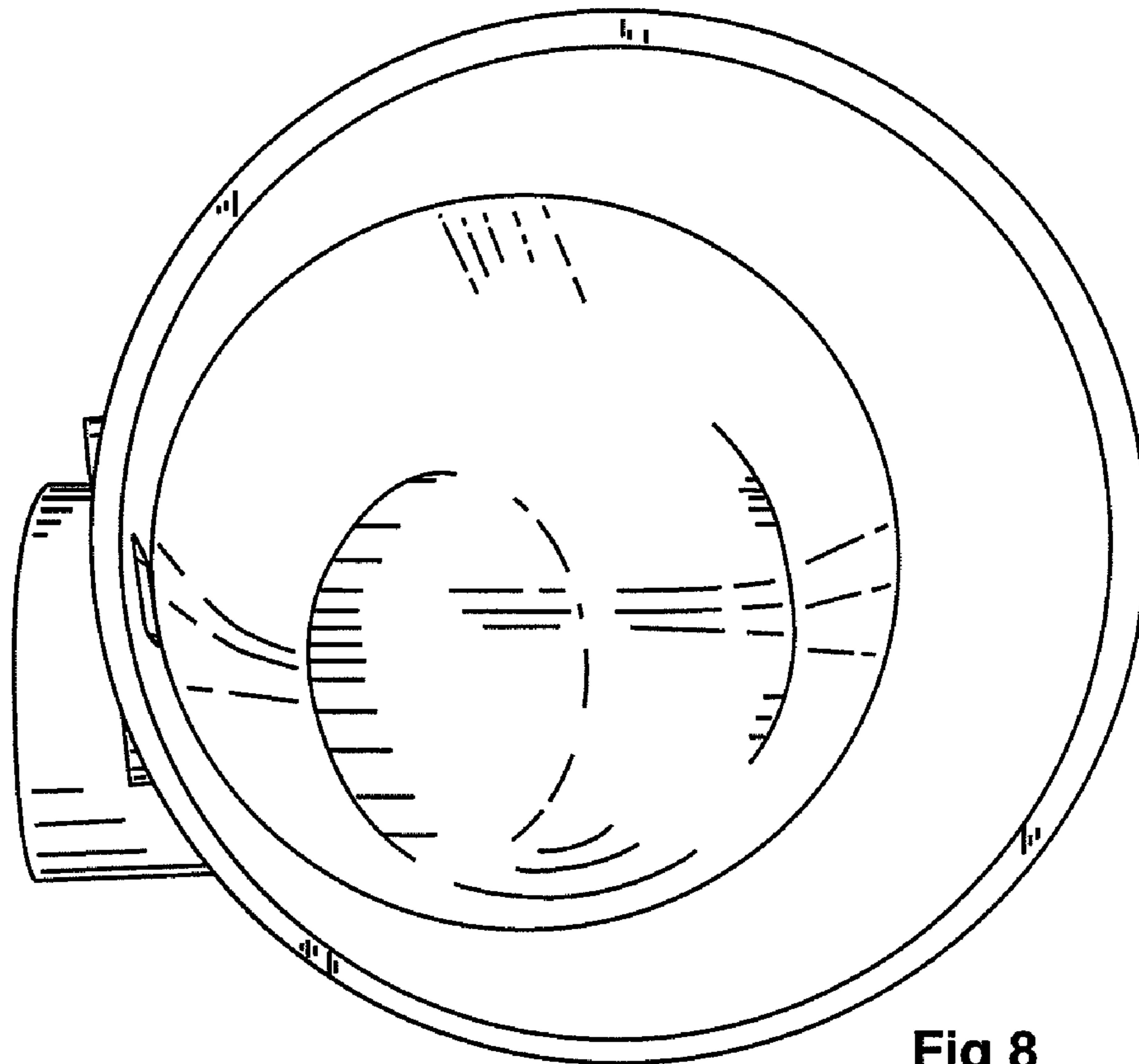

Fig 8