

US00D661693S

(12) **United States Design Patent**  
**Andre et al.**

(10) **Patent No.:** **US D661,693 S**  
(45) **Date of Patent:** **\*\* Jun. 12, 2012**

(54) **ELECTRONIC DEVICE**

(56) **References Cited**

(75) Inventors: **Bartley K. Andre**, Menlo Park, CA (US); **Daniel J. Coster**, San Francisco, CA (US); **Daniele De Iuliis**, San Francisco, CA (US); **Evans Hankey**, San Francisco, CA (US); **Richard P. Howarth**, San Francisco, CA (US); **Jonathan P. Ive**, San Francisco, CA (US); **Steve Jobs**, Palo Alto, CA (US); **Duncan Robert Kerr**, San Francisco, CA (US); **Shin Nishibori**, Portola Valley, CA (US); **Matthew Dean Rohrbach**, San Francisco, CA (US); **Peter Russell-Clarke**, San Francisco, CA (US); **Douglas B. Satzger**, Menlo Park, CA (US); **Christopher J. Stringer**, Woodside, CA (US); **Eugene Antony Whang**, San Francisco, CA (US); **Rico Zorkendorfer**, San Francisco, CA (US)

U.S. PATENT DOCUMENTS

D463,797 S	10/2002	Andre et al.	
D491,177 S	6/2004	Andre et al.	
D493,785 S	8/2004	Andre et al.	
D558,752 S	1/2008	Andre et al.	
D558,753 S	1/2008	Andre et al.	
D571,364 S	6/2008	Andre et al.	
D572,247 S	7/2008	Andre et al.	
D574,378 S	8/2008	Andre et al.	
D589,507 S	3/2009	Andre et al.	
D604,294 S	11/2009	Andre et al.	
D611,469 S	3/2010	Andre et al.	
D616,881 S	6/2010	Andre et al.	
D635,566 S *	4/2011	Andre et al.	..... D14/318

OTHER PUBLICATIONS

U.S. Appl. No. 29/345,429 entitled "Electronic Device" filed Oct. 15, 2009.

(Continued)

*Primary Examiner* — Freda S Nunn

(74) *Attorney, Agent, or Firm* — SAIDMAN Design Law Group

(73) Assignee: **Apple Inc.**, Cupertino, CA (US)

(\*\*) Term: **14 Years**

(21) Appl. No.: **29/387,659**

(22) Filed: **Mar. 16, 2011**

**Related U.S. Application Data**

(60) Continuation of application No. 29/375,023, filed on Sep. 16, 2010, now Pat. No. Des. 635,566, which is a continuation of application No. 29/345,429, filed on Oct. 15, 2009, now Pat. No. Des. 625,717, which is a division of application No. 29/294,500, filed on Jan. 14, 2008, now Pat. No. Des. 604,294.

(51) **LOC (9) Cl.** ..... **14-02**

(52) **U.S. Cl.** ..... **D14/315**

(58) **Field of Classification Search** ..... D14/315-327, D14/455; D18/1, 2, 7, 11; 235/145 A, 145 R; 341/22, 23; 345/156, 157, 168, 169, 173; 361/679.08, 679.09, 679.26, 679.27; 348/373; 715/783; 400/486, 489

See application file for complete search history.

(57) **CLAIM**

The ornamental design for an electronic device, as shown and described.

**DESCRIPTION**

FIG. 1 is a front, top perspective view of an electronic device showing our new design;  
FIG. 2 is a rear, bottom perspective view thereof;  
FIG. 3 is a front view thereof;  
FIG. 4 is a rear view thereof;  
FIG. 5 is a left side view thereof;  
FIG. 6 is a right side view thereof;  
FIG. 7 is a top view thereof; and,  
FIG. 8 is a bottom view thereof.  
The broken lines illustrate portions of the electronic device and form no part of the claimed design.

**1 Claim, 6 Drawing Sheets**

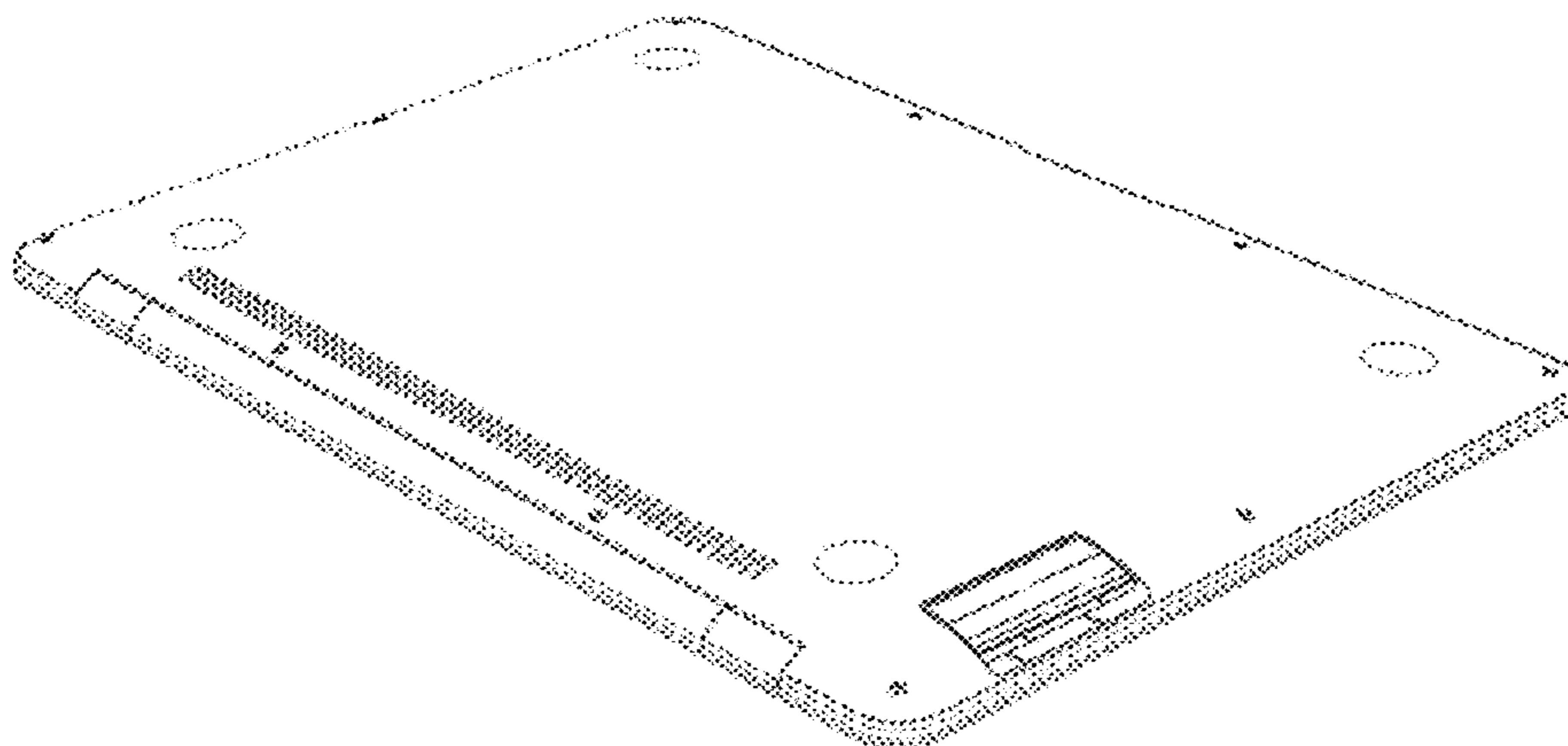

OTHER PUBLICATIONS

U.S. Appl. No. 29/366,369 entitled "Portable Computer" filed Jul. 23, 2010.

Apple PowerBook G4 Titanium, available at least as early as Jan. 1, 2001.

Apple PowerBook G4 Aluminum, available at least as early as Jan. 1, 2003.

Apple MacBook Pro, available at least as early as Jan. 10, 2006.

Apple MacBook Air, available Jan. 15, 2008, [http://images.apple.com/macbookair/images/design\\_gal01\\_20080115.jpg](http://images.apple.com/macbookair/images/design_gal01_20080115.jpg).

Apple MacBook Air, available Jan. 15, 2008, [http://images.apple.com/macbookair/images/design\\_gal02\\_20080115.jpg](http://images.apple.com/macbookair/images/design_gal02_20080115.jpg).

Apple MacBook Air, available Jan. 15, 2008, [http://images.apple.com/macbookair/images/design\\_gal03\\_20080115.jpg](http://images.apple.com/macbookair/images/design_gal03_20080115.jpg).

Apple MacBook Air, available Jan. 15, 2008, [http://images.apple.com/macbookair/images/design\\_gal04\\_20080115.jpg](http://images.apple.com/macbookair/images/design_gal04_20080115.jpg).

Apple MacBook Air, available Jan. 15, 2008, [http://images.apple.com/macbookair/images/design\\_thinair20080115](http://images.apple.com/macbookair/images/design_thinair20080115).

Apple MacBook Air, available Jan. 15, 2008, [http://images.apple.com/macbookair/images/design\\_displayair20080115.jpg](http://images.apple.com/macbookair/images/design_displayair20080115.jpg).

Apple MacBook Air, available Jan. 15, 2008, [http://images.apple.com/macbookair/images/design\\_keyboardair20080115.jpg](http://images.apple.com/macbookair/images/design_keyboardair20080115.jpg).

Apple MacBook Air, available Jan. 15, 2008, [http://images.apple.com/macbookair/images/design\\_gal08\\_20080115.jpg](http://images.apple.com/macbookair/images/design_gal08_20080115.jpg).

U.S. Appl. No. 29/365,032, filed Jul. 1, 2010, entitled "Electronic Device".

\* cited by examiner

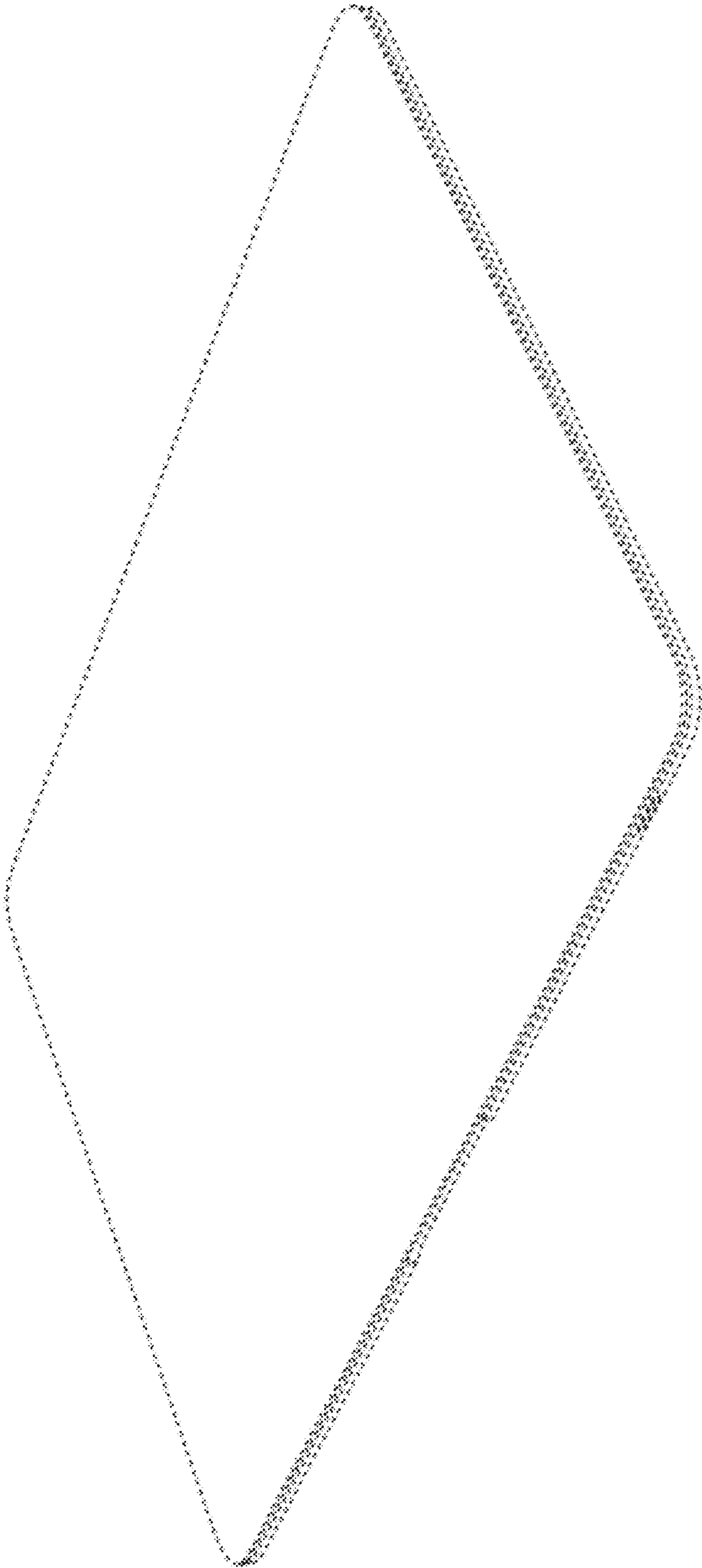

**Fig. 1**

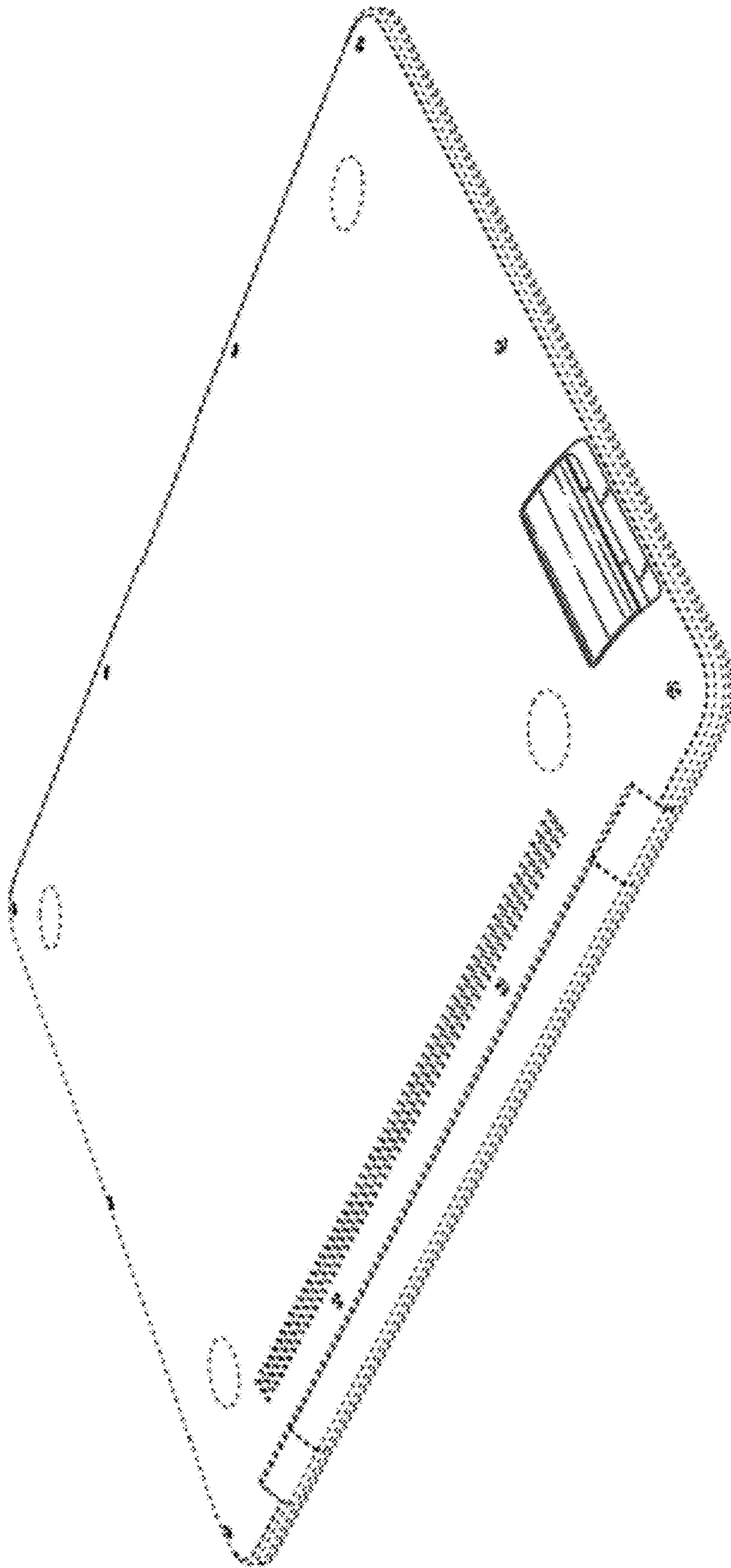

**Fig. 2**



**Fig. 3**



**Fig. 4**

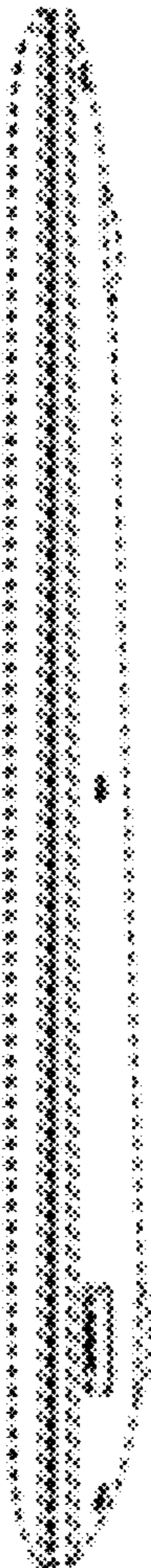

**Fig. 5**

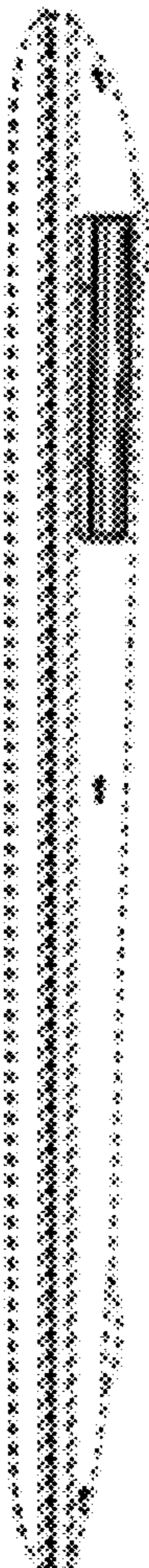

**Fig. 6**

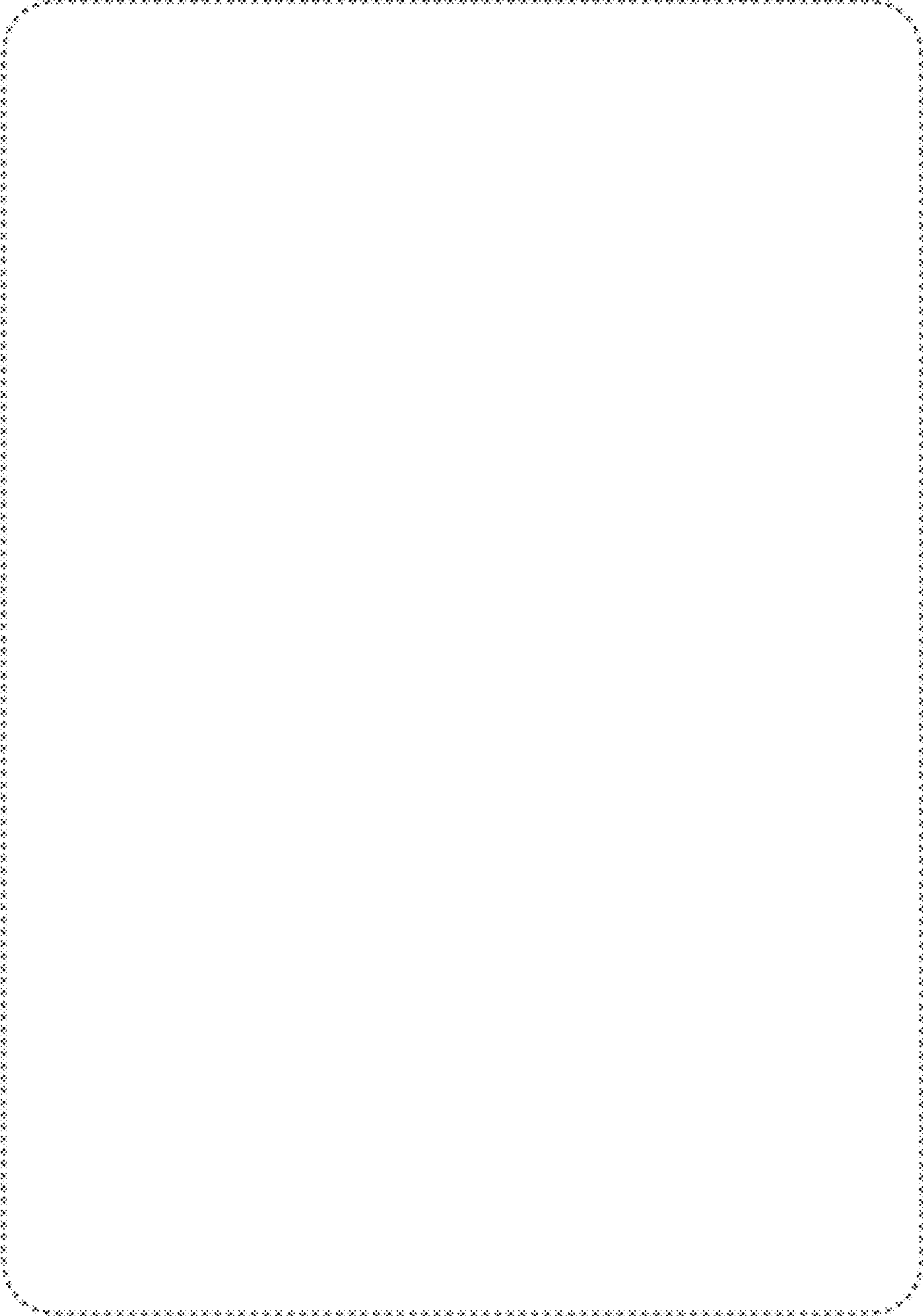

**Fig. 7**

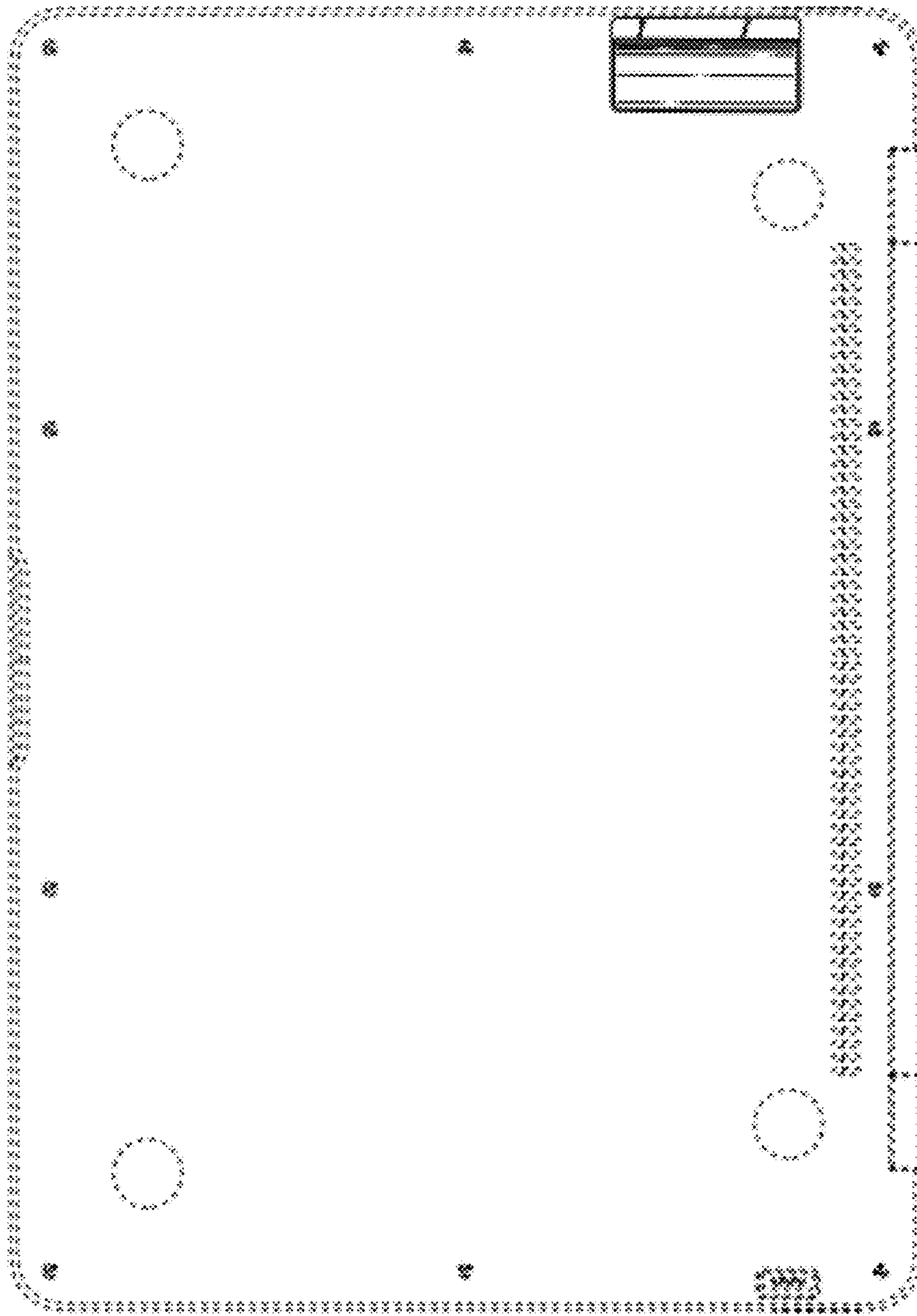

Fig. 8