

US00D661551S

(12) **United States Design Patent**  
**Gilbert**

(10) **Patent No.:** **US D661,551 S**

(45) **Date of Patent:** **\*\* Jun. 12, 2012**

(54) **FOOD CONTAINER**

(75) Inventor: **Tyler Sean Gilbert**, Bellevue, WA (US)

(73) Assignee: **Pacific Market International, LLC**,  
Seattle, WA (US)

(\*\*) Term: **14 Years**

(21) Appl. No.: **29/380,004**

(22) Filed: **Nov. 29, 2010**

(51) **LOC (9) Cl.** ..... **07-07**

(52) **U.S. Cl.** ..... **D7/629**

(58) **Field of Classification Search** ..... D7/601,  
D7/602, 629, 630, 538-542, 612-615; D9/424-432;  
220/780-806, 574-575, 326, 236, 675, 324,  
220/4.22-4.25

See application file for complete search history.

(56) **References Cited**

**U.S. PATENT DOCUMENTS**

D446,084 S *	8/2001	Schulein	.....	D7/629
D543,077 S *	5/2007	Kim	.....	D7/629
D582,218 S *	12/2008	Curtin	.....	D7/629
D613,598 S *	4/2010	Westphal	.....	D9/503

\* cited by examiner

*Primary Examiner* — Terry Wallace

(74) *Attorney, Agent, or Firm* — Davis Wright Tremaine  
LLP; George C. Rondeau, Jr.

(57) **CLAIM**

The ornamental design for a food container, as shown and  
described.

**DESCRIPTION**

FIG. 1 is a top, front perspective view of a food container  
showing my new design.

FIG. 2 is a left side view thereof.

FIG. 3 is a right side view thereof.

FIG. 4 is a front view thereof.

FIG. 5 is a rear view thereof.

FIG. 6 is a top plan view thereof.

FIG. 7 is a bottom plan view thereof.

FIG. 8 is a top, front perspective view of an alternate embodi-  
ment of FIG. 1.

FIG. 9 is a left side view of FIG. 8.

FIG. 10 is a right side view of FIG. 8.

FIG. 11 is a front view of FIG. 8.

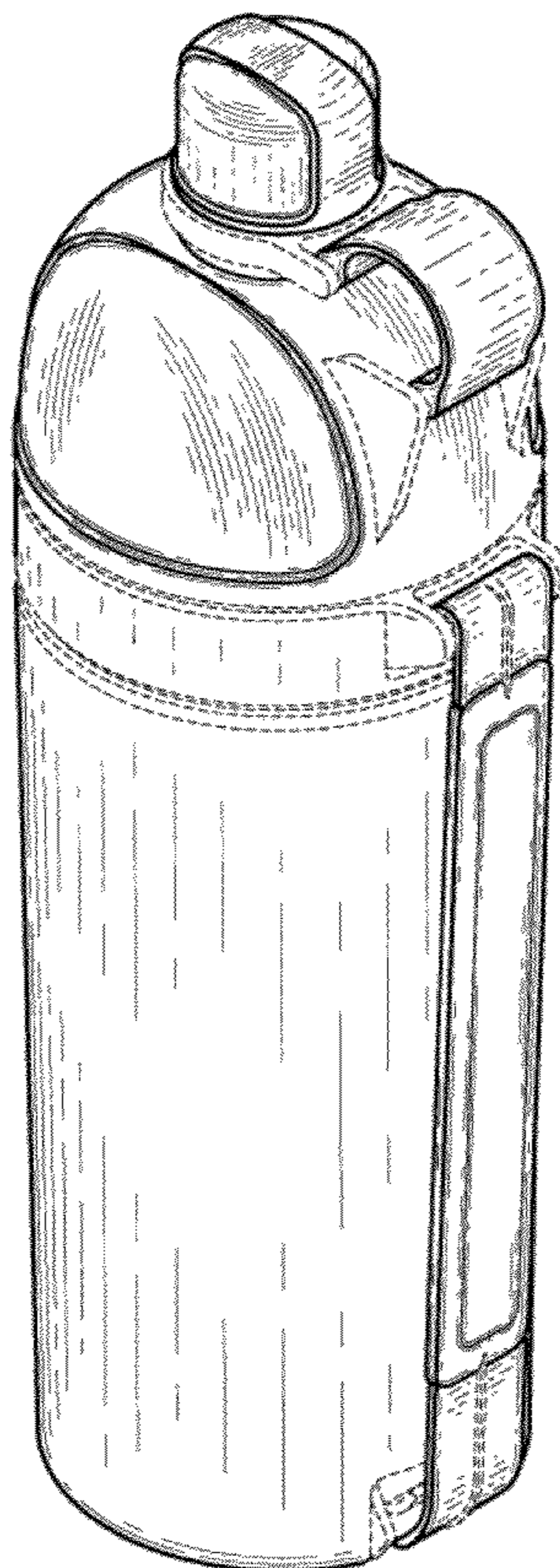
FIG. 12 is a rear view of FIG. 8.

FIG. 13 is a top plan view of FIG. 8; and,

FIG. 14 is a bottom plan view of FIG. 8.

The broken lines represent portions of the food container that  
form no part of the claim.

**1 Claim, 9 Drawing Sheets**



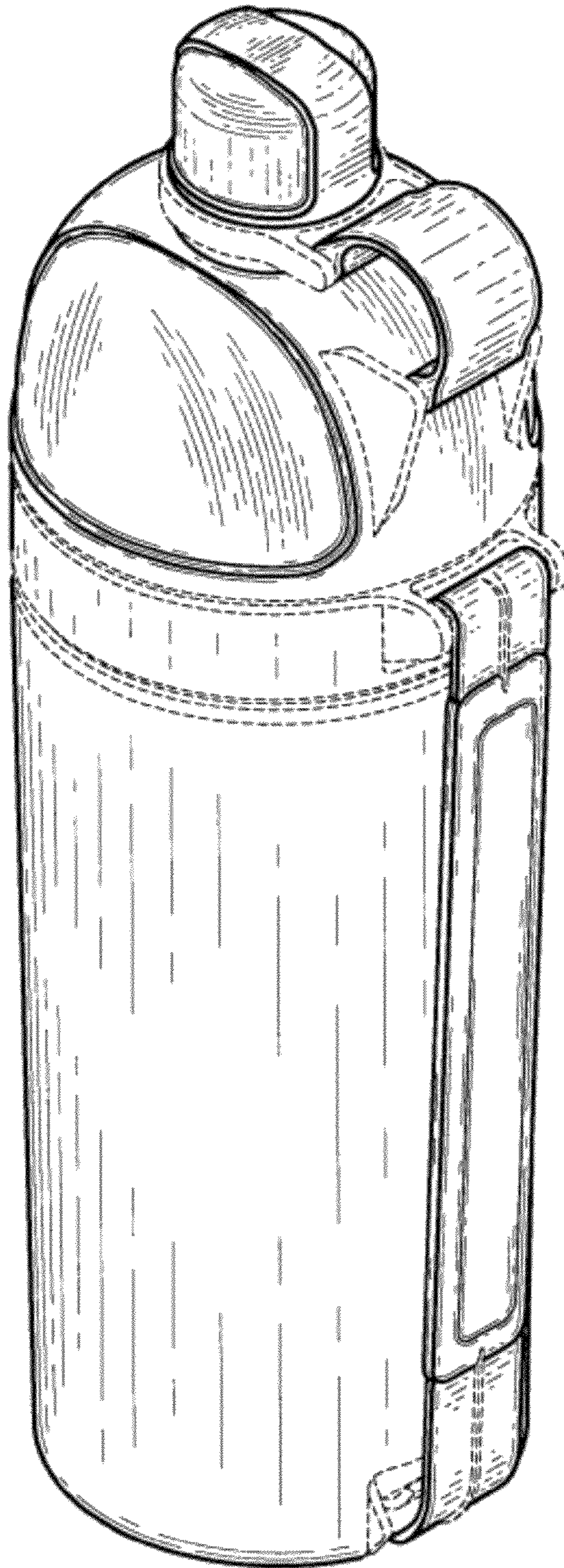


Fig. 1



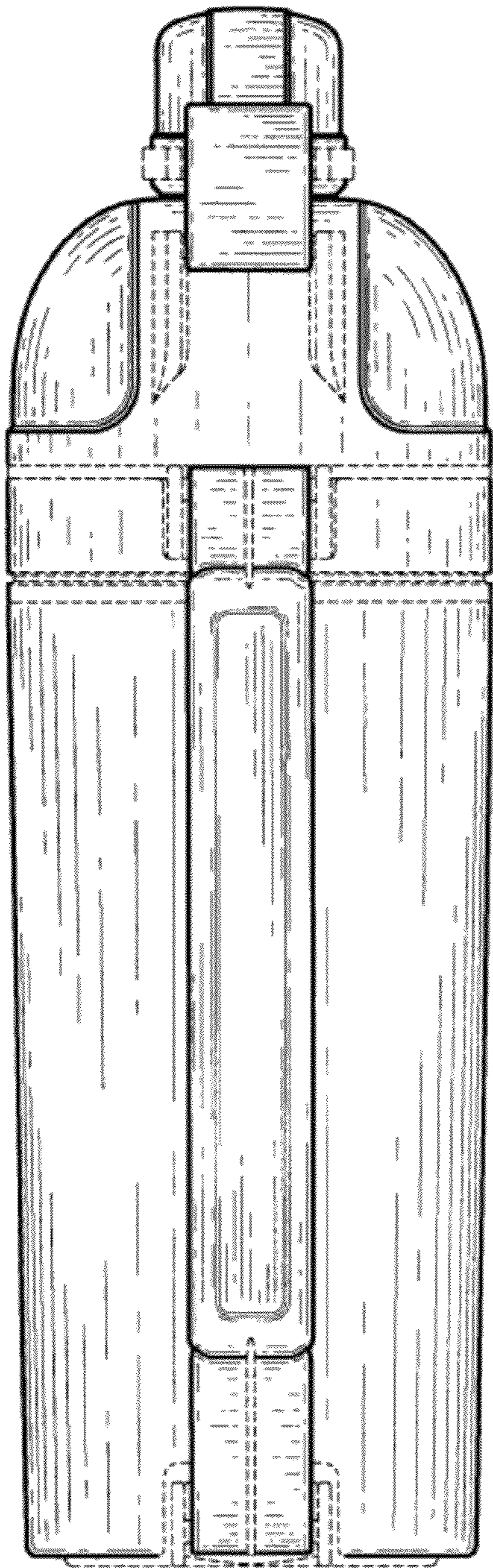


Fig. 2

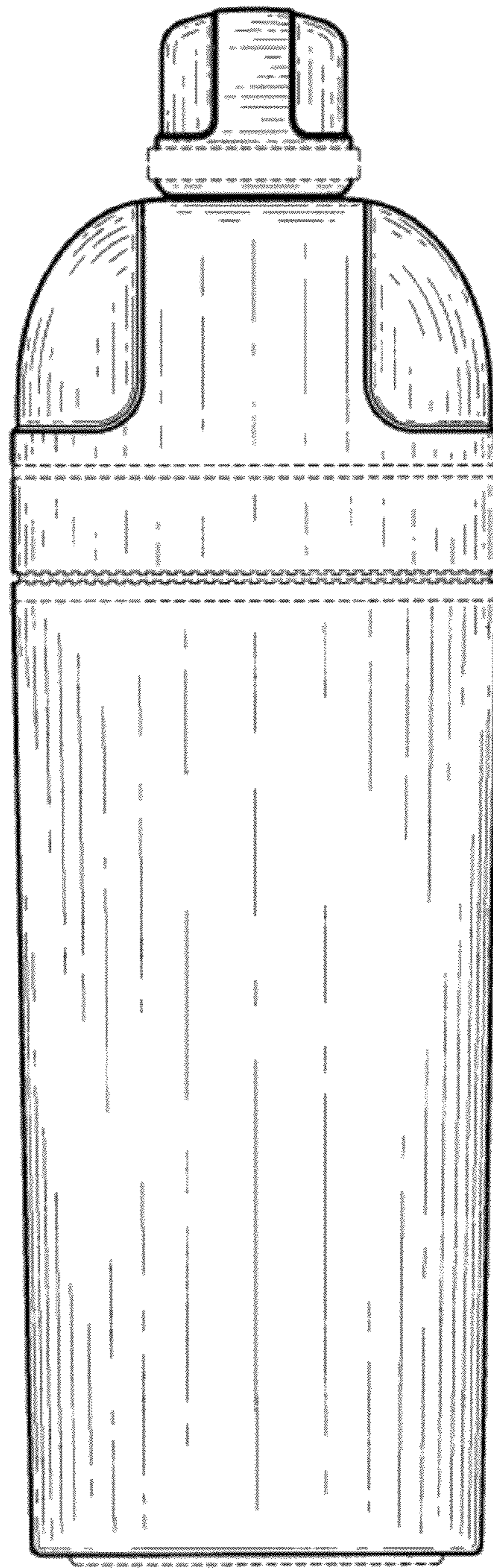


Fig. 3



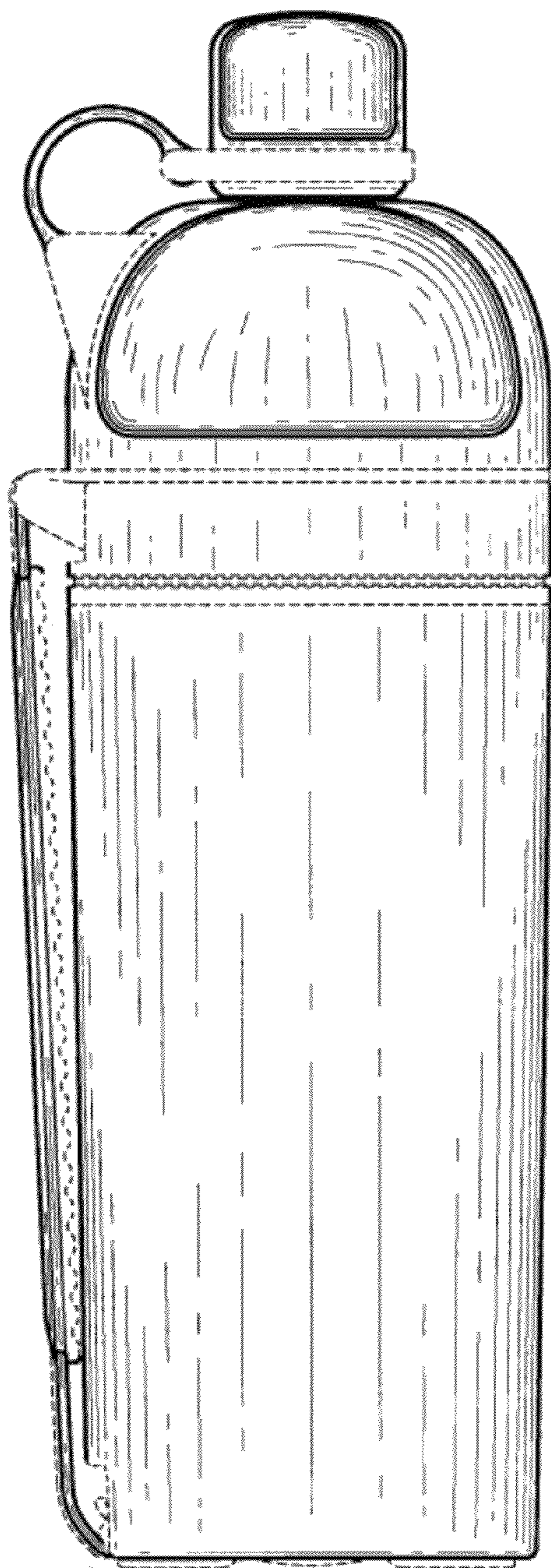


Fig. 4

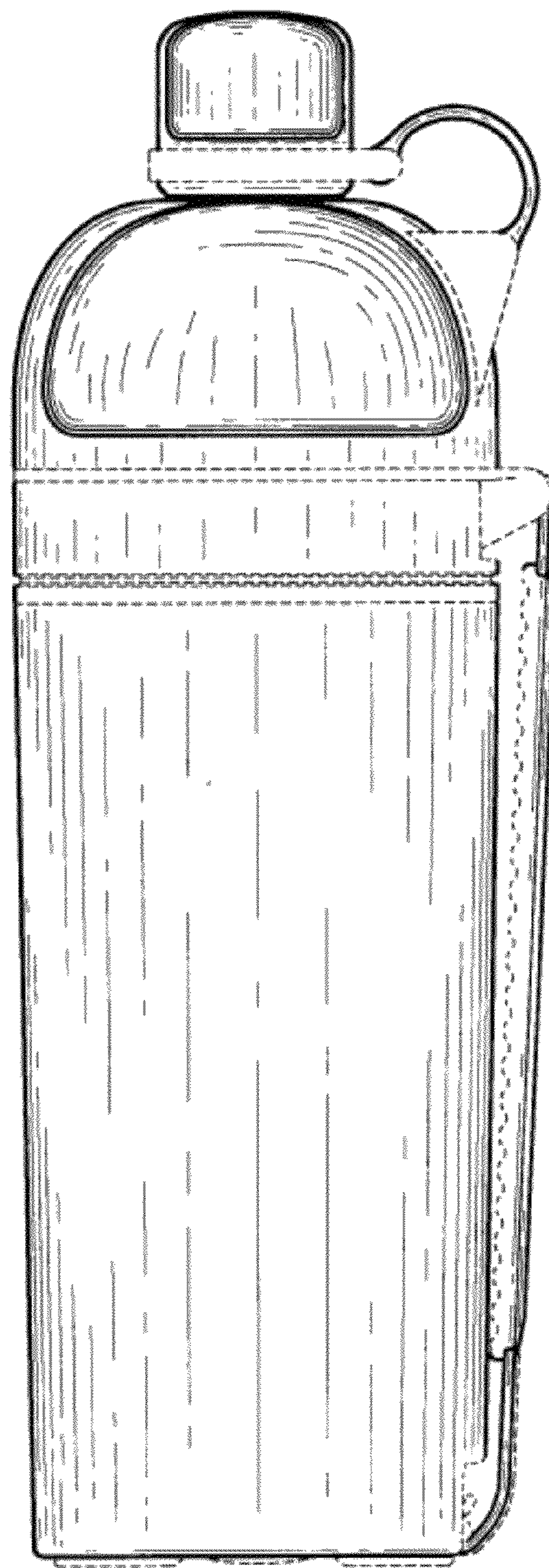


Fig. 5



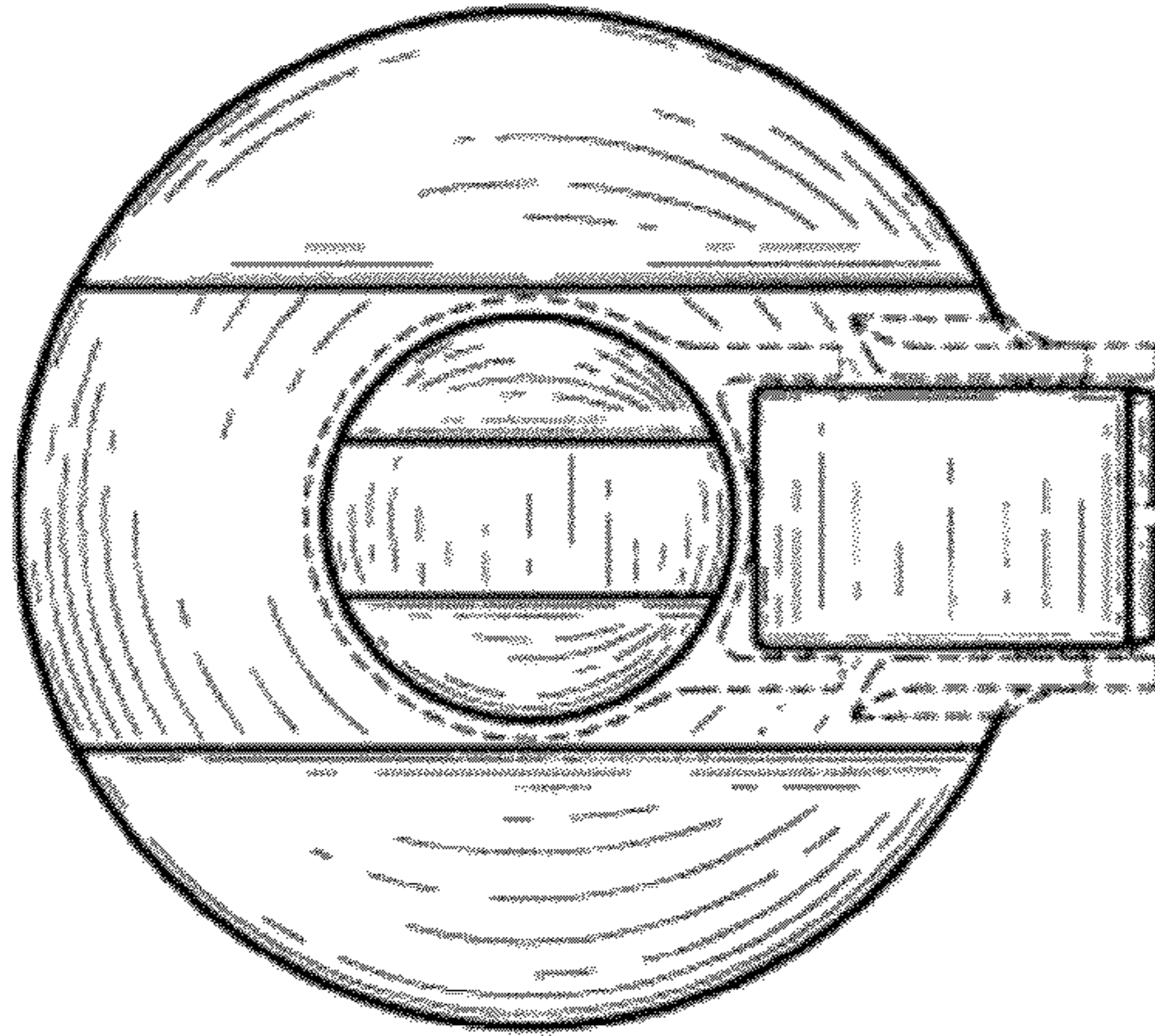


Fig. 6

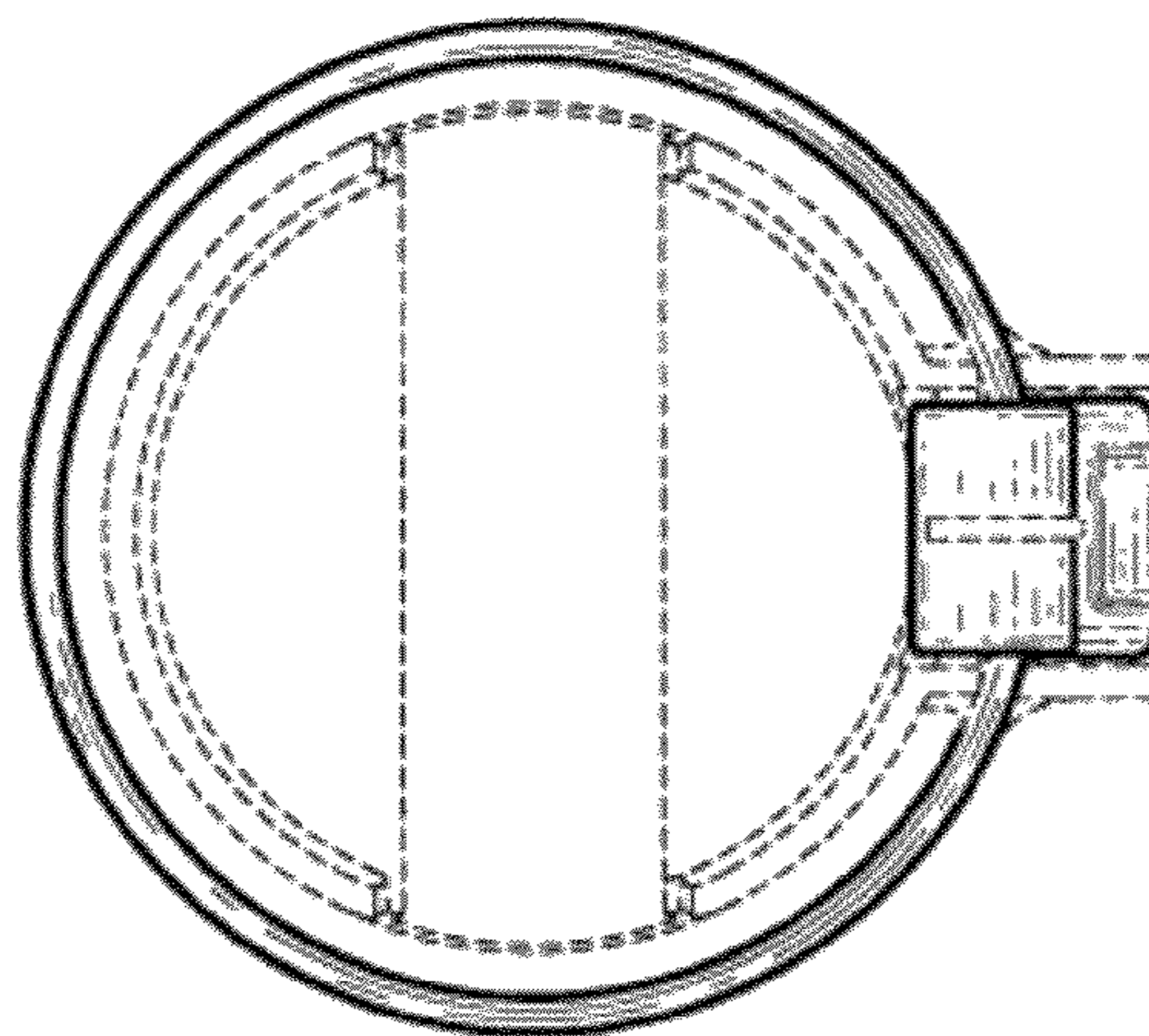
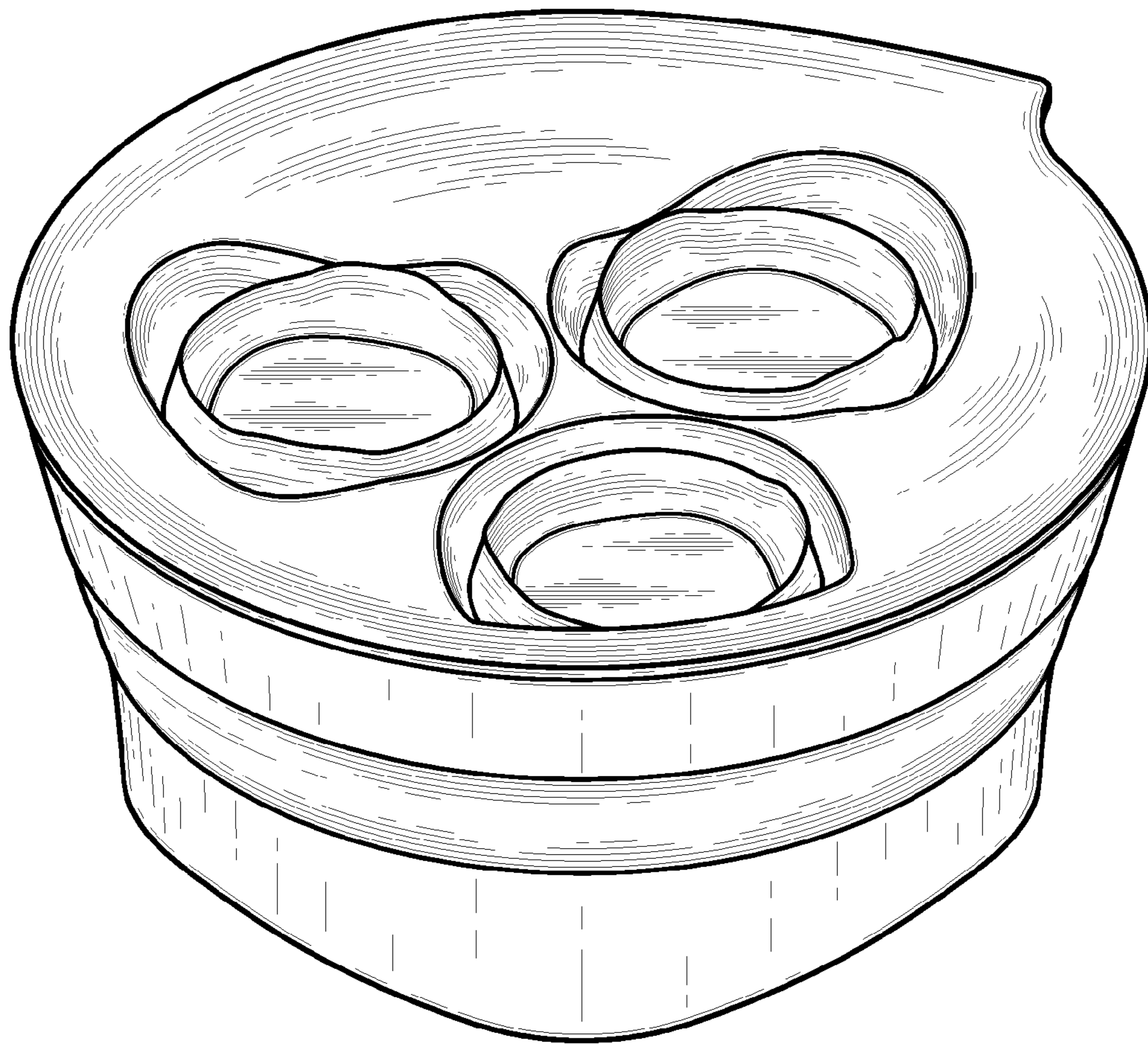
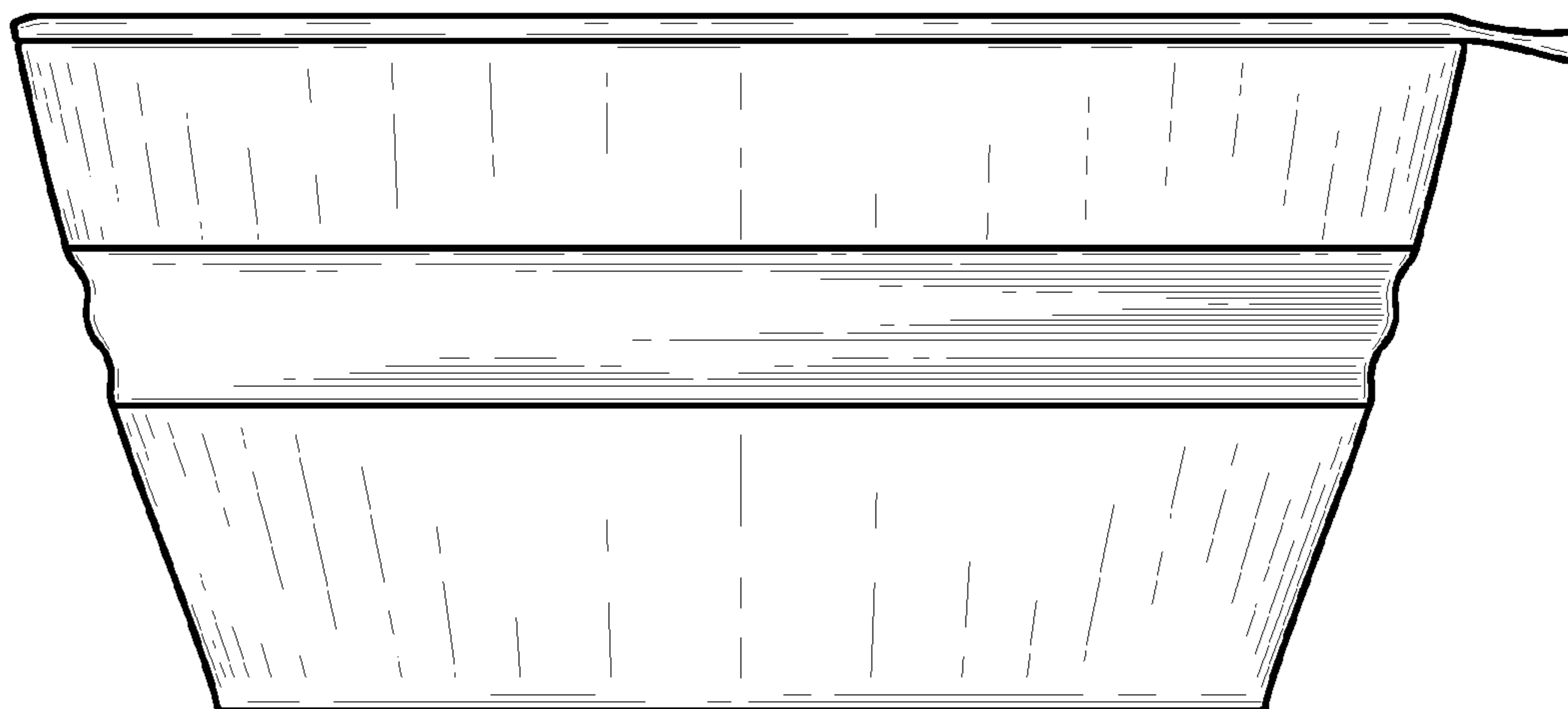


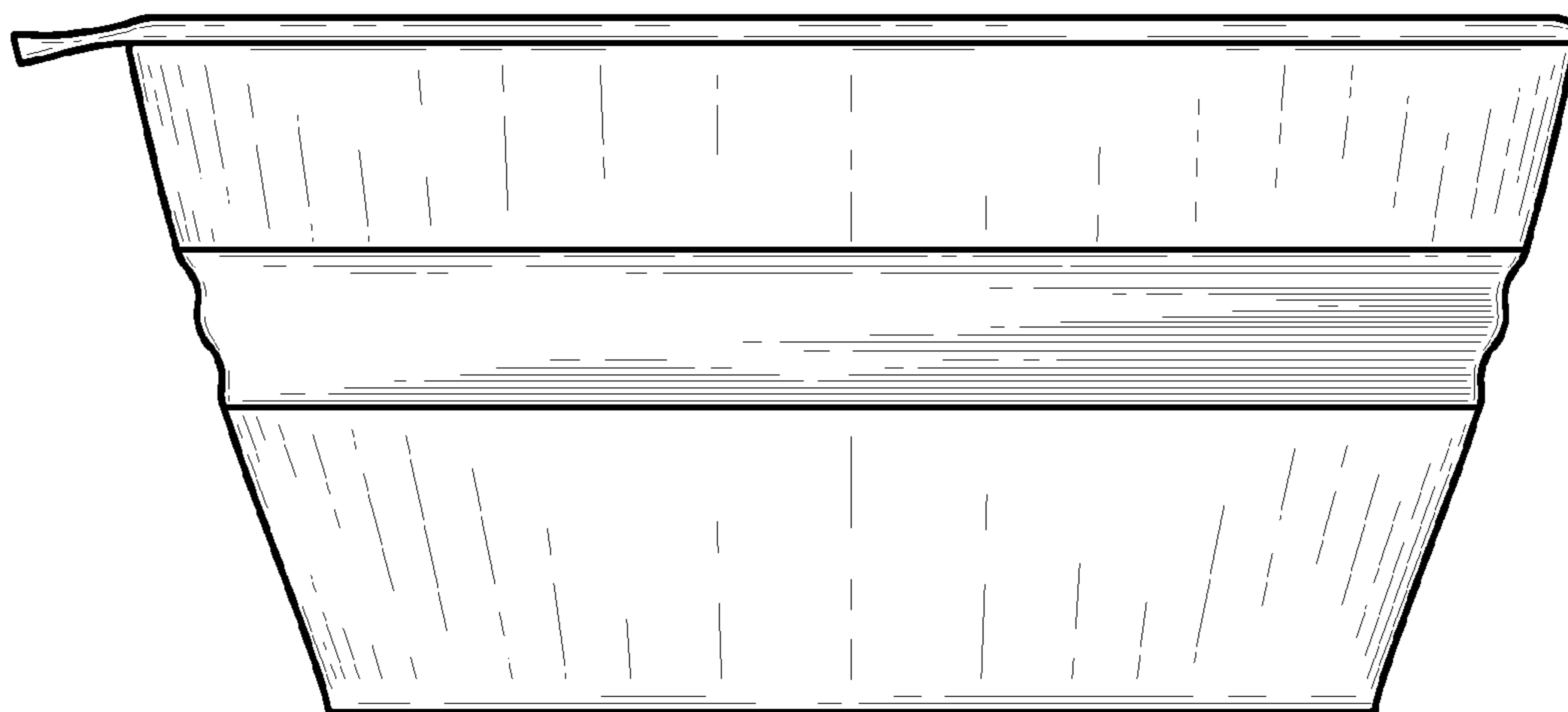
Fig. 7



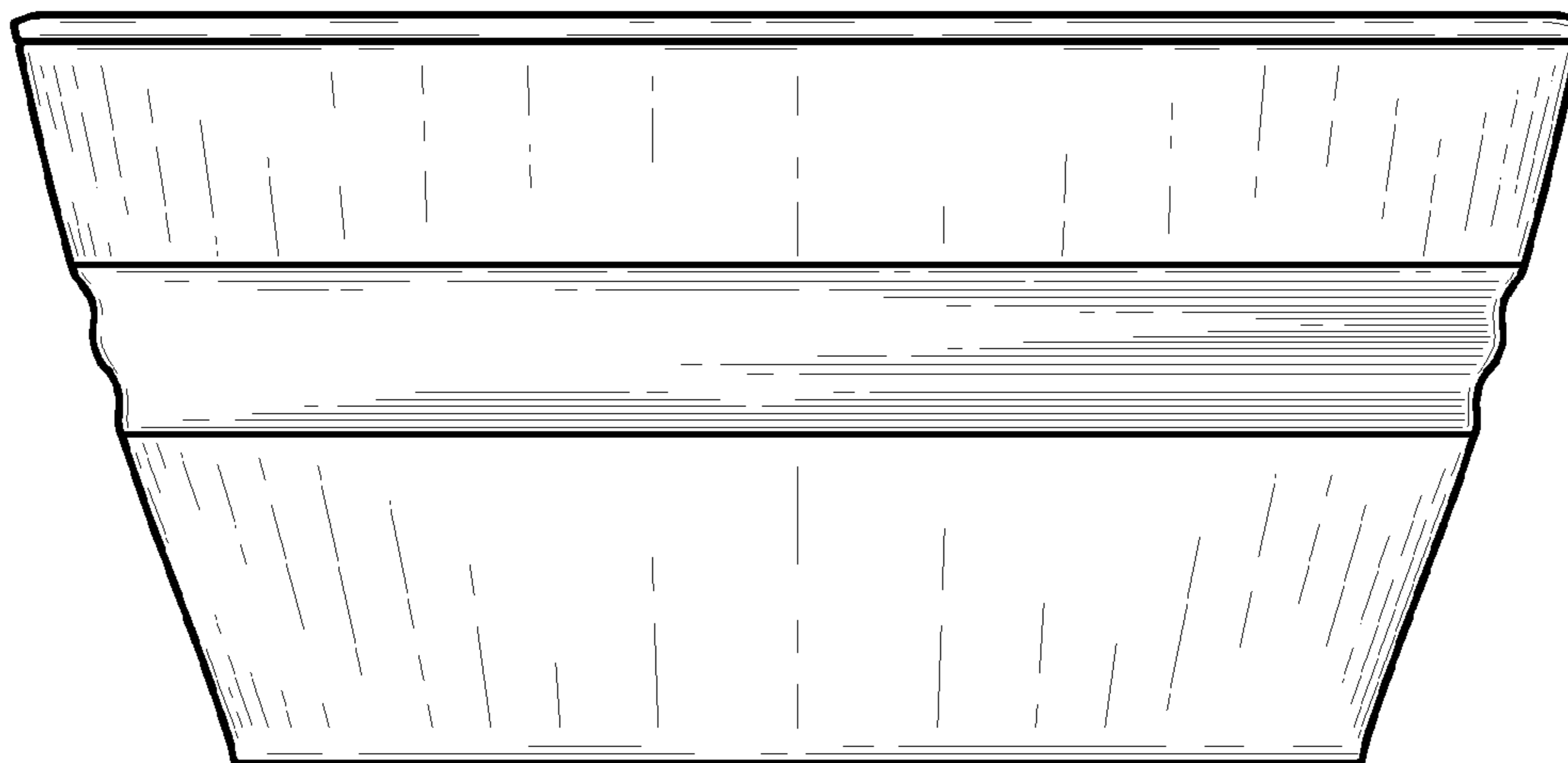
*Fig. 8*



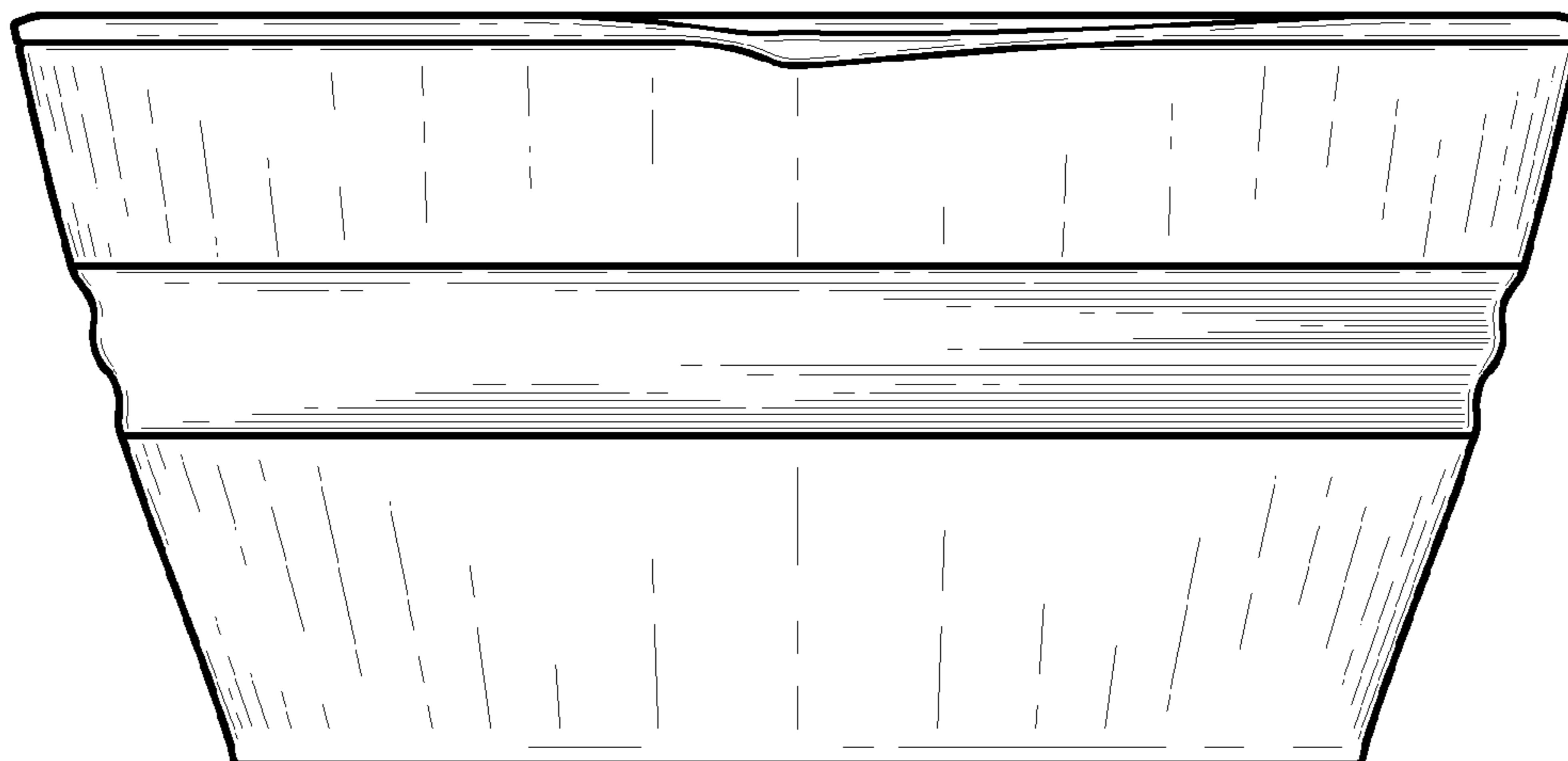
*Fig. 9*



*Fig. 10*

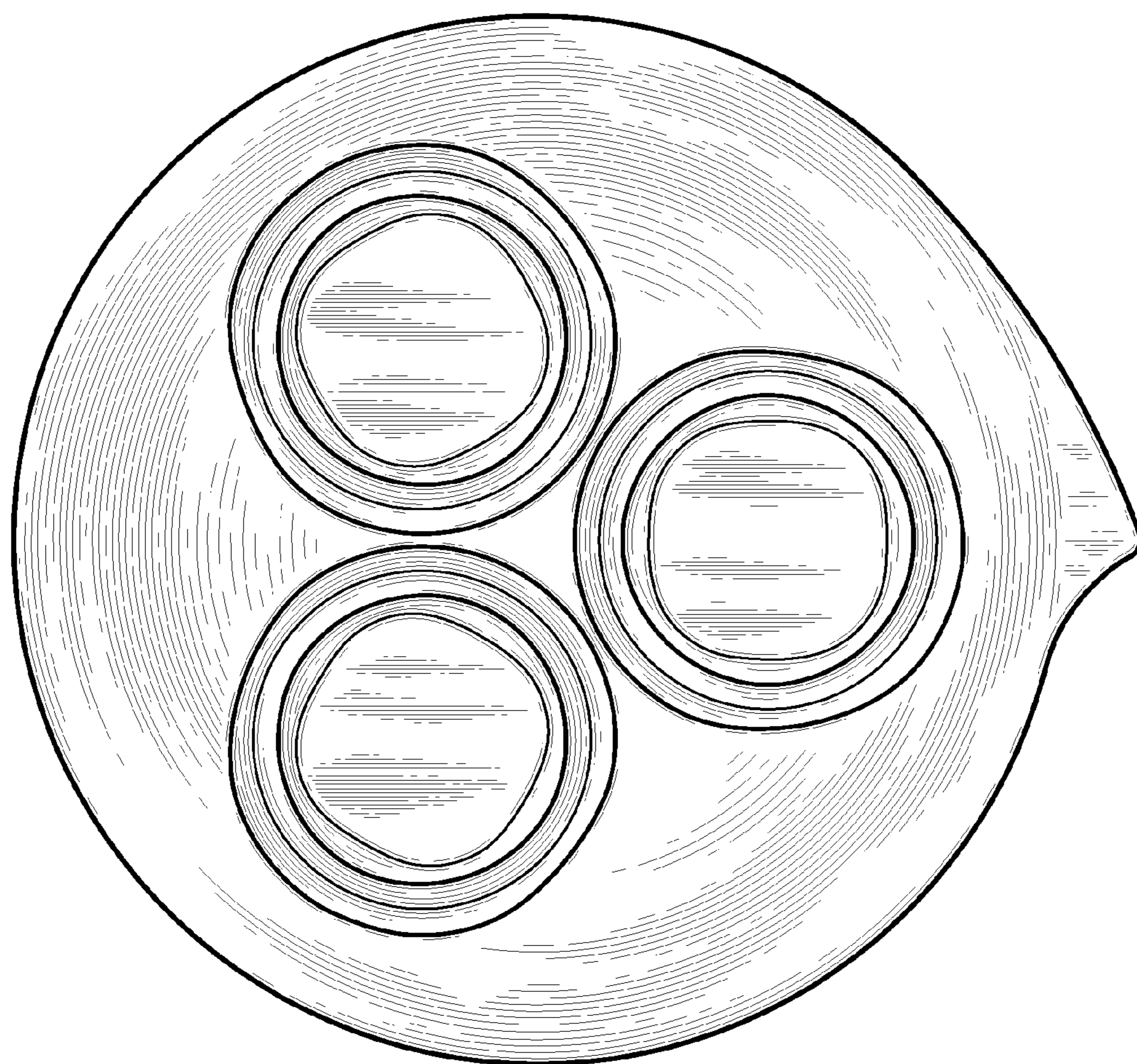


*Fig. 11*

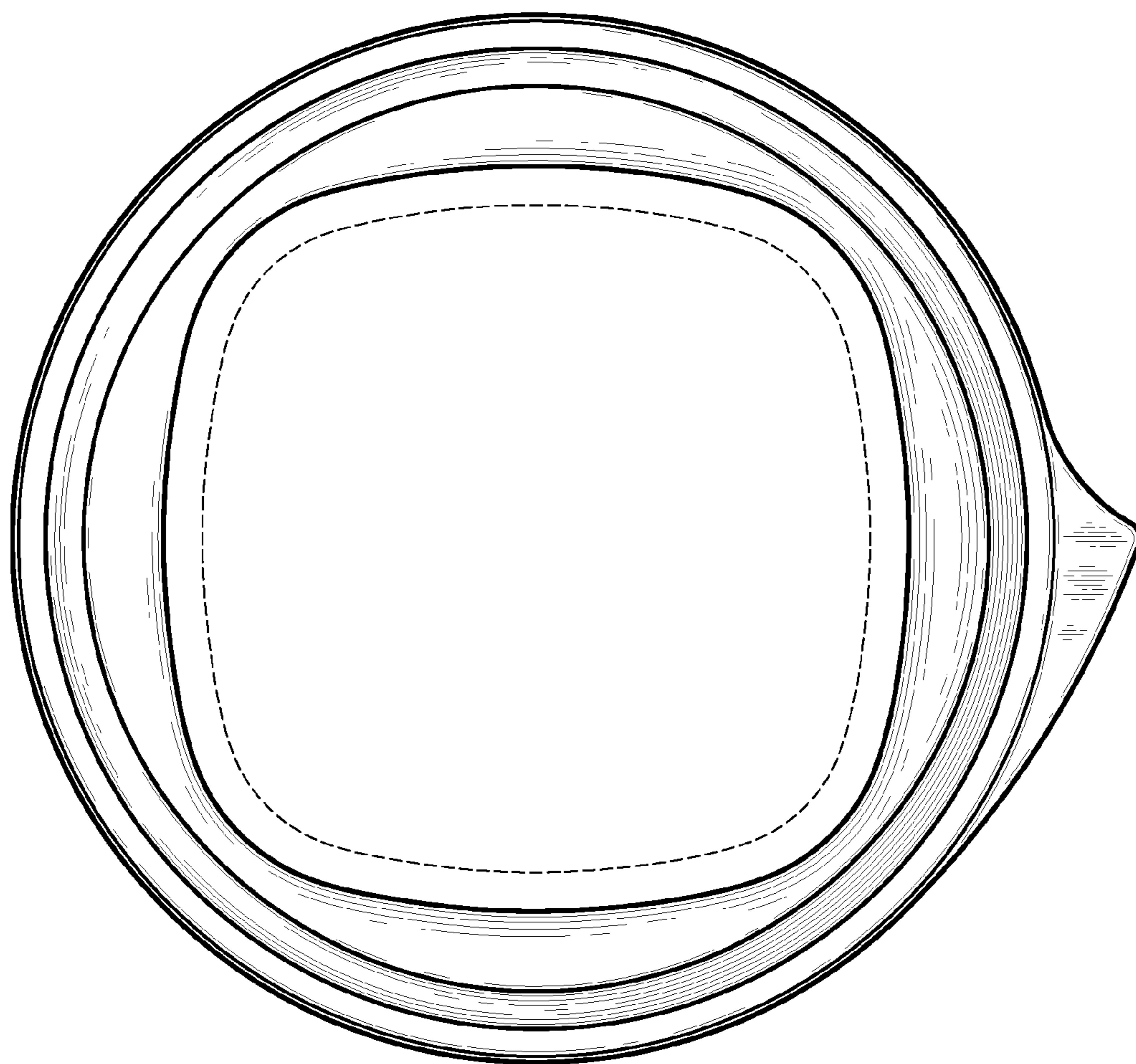


*Fig. 12*





*Fig. 13*



*Fig. 14*



UNITED STATES PATENT AND TRADEMARK OFFICE  
**CERTIFICATE OF CORRECTION**

PATENT NO. : D661,551 S  
APPLICATION NO. : 29/380004  
DATED : June 12, 2012  
INVENTOR(S) : Gilbert

Page 1 of 12

It is certified that error appears in the above-identified patent and that said Letters Patent is hereby corrected as shown below:

Please delete the title page and insert the title page showing an illustrative figure as attached.

In the Drawings

Please Delete drawing sheets 1-9 and insert drawing sheets 1-10 with figures 1-14 as attached.

This certificate supersedes the Certificate of Correction issued March 15, 2011.

Signed and Sealed this  
Twenty-fourth Day of September, 2013



Teresa Stanek Rea  
*Deputy Director of the United States Patent and Trademark Office*

(12) **United States Design Patent** (10) **Patent No.:** **US D661,551 S**  
**Gilbert** (45) **Date of Patent:** **\*\* Jun. 12, 2012**

(54) **FOOD CONTAINER**

(74) *Attorney, Agent, or Firm*—Davis Wright Tremaine LLP; George C. Rondeau, Jr.

(75) **Inventor:** Tyler Sean Gilbert, Bellevue, WA (US)

(73) **Assignee:** Pacific Market International, LLC, Seattle, WA (US)

(57) **CLAIM**  
 The ornamental design for a food container, as shown and described.

(\*\*) **Term:** 14 Years

(21) **Appl. No.:** 29/380,004

**DESCRIPTION**

(22) **Filed:** Nov. 29, 2010

FIG. 1 is a top, front perspective view of a food container showing my new design.

(51) **LOC (9) Cl.** ..... 07-07

FIG. 2 is a left side view thereof.

(52) **U.S. Cl.** ..... D7/629

FIG. 3 is a right side view thereof.

(58) **Field of Classification Search** ..... D7/601,

D7/602, 629, 630, 538-542, 612-615; D9/424-432; 220/780-806, 574-575, 326, 236, 675, 324, 220/4.22-4.25

FIG. 4 is a front view thereof.

FIG. 5 is a rear view thereof.

FIG. 6 is a top plan view thereof.

FIG. 7 is a bottom plan view thereof.

See application file for complete search history.

FIG. 8 is a top, front perspective view of an alternate embodiment of FIG. 1.

FIG. 9 is a left side view of FIG. 8.

FIG. 10 is a right side view of FIG. 8.

FIG. 11 is a front view of FIG. 8.

FIG. 12 is a rear view of FIG. 8.

FIG. 13 is a top plan view of FIG. 8; and,

FIG. 14 is a bottom plan view of FIG. 8.

The broken lines represent portions of the food container that form no part of the claim.

(56) **References Cited**

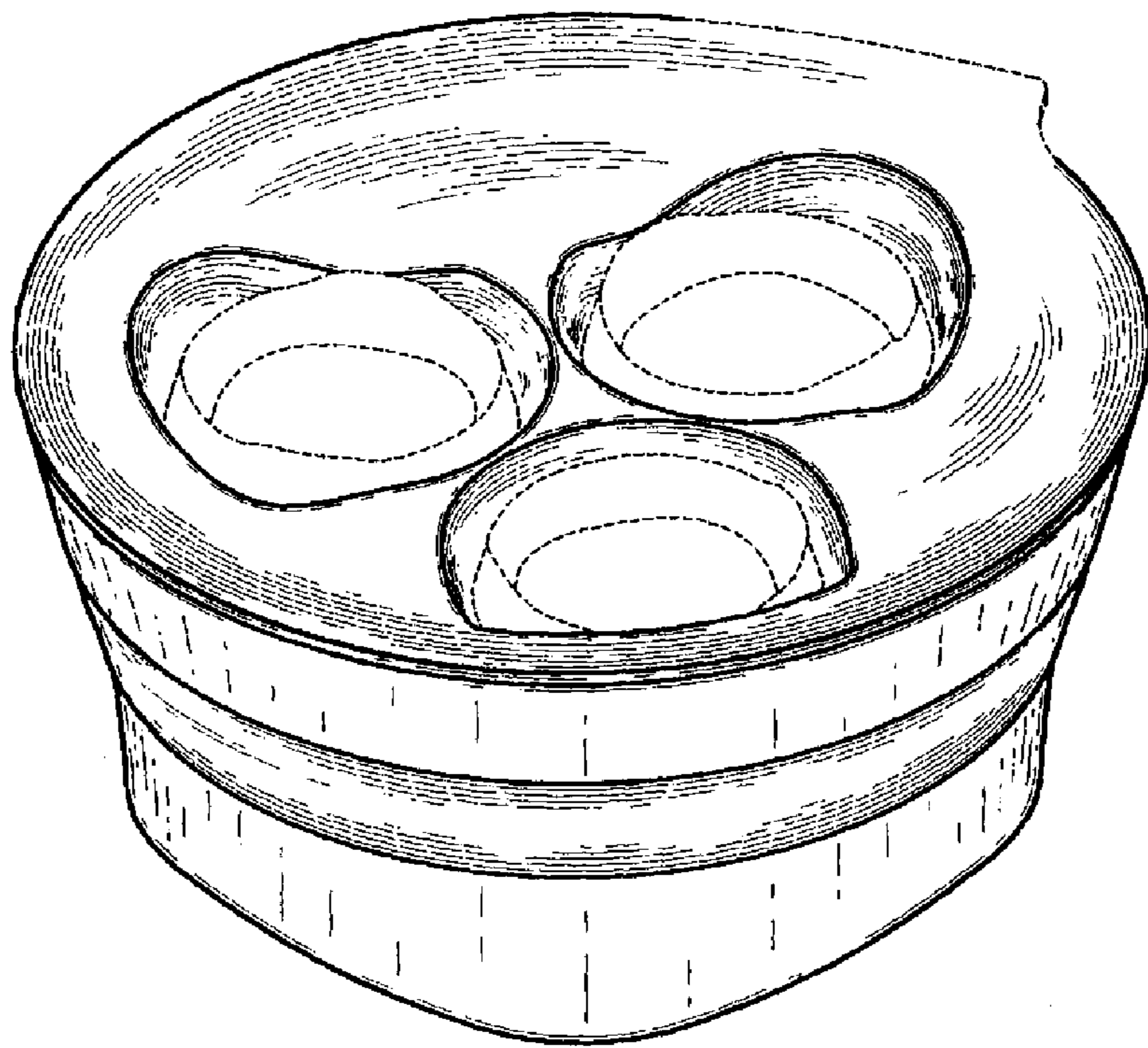
**U.S. PATENT DOCUMENTS**

D446,084 S *	8/2001	Schulein	.....	D7/629
D543,077 S *	5/2007	Kim	.....	D7/629
D582,218 S *	12/2008	Curtin	.....	D7/629
D613,598 S *	4/2010	Westphal	.....	D9/503

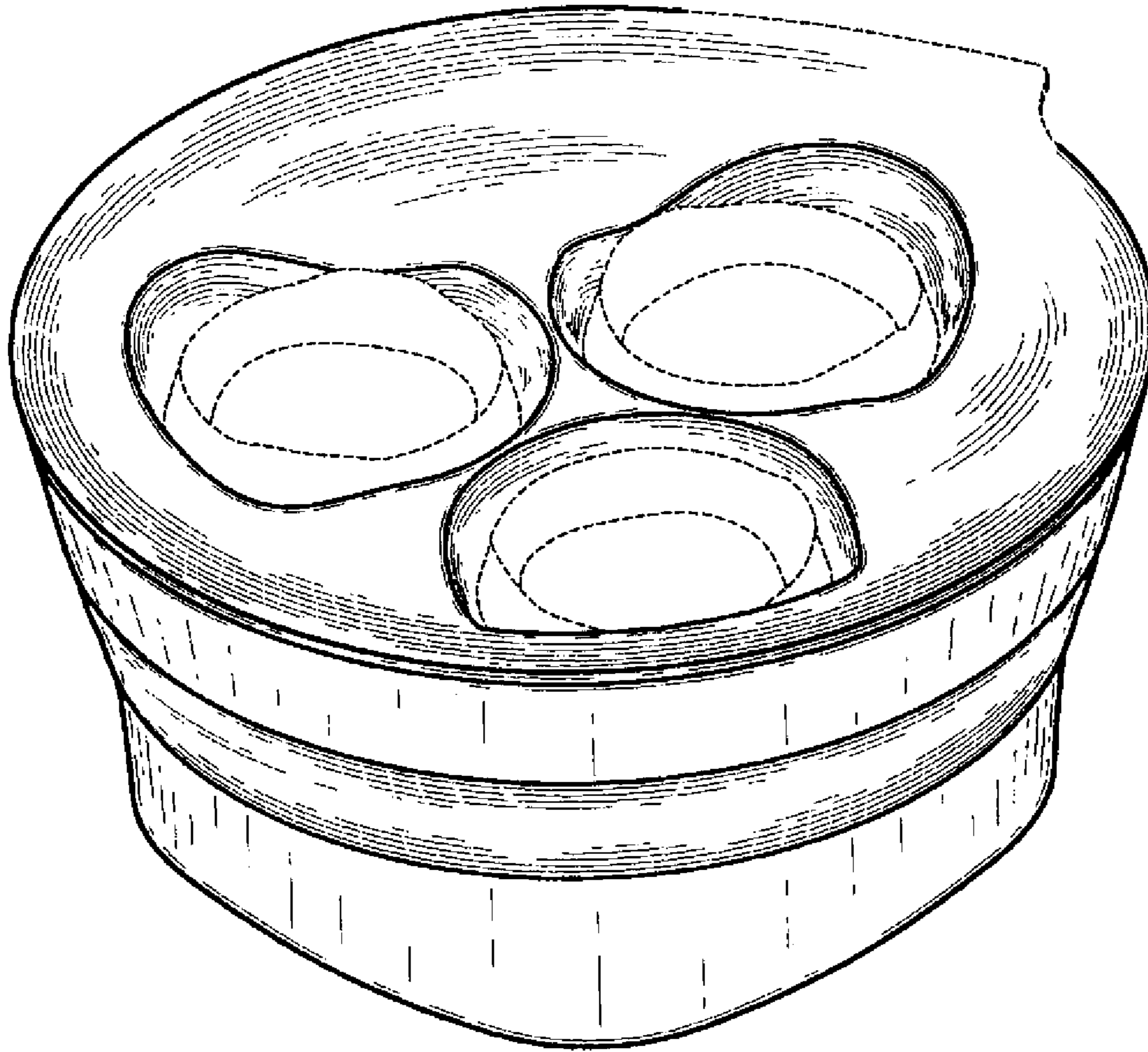
\* cited by examiner

*Primary Examiner* — Terry Wallace

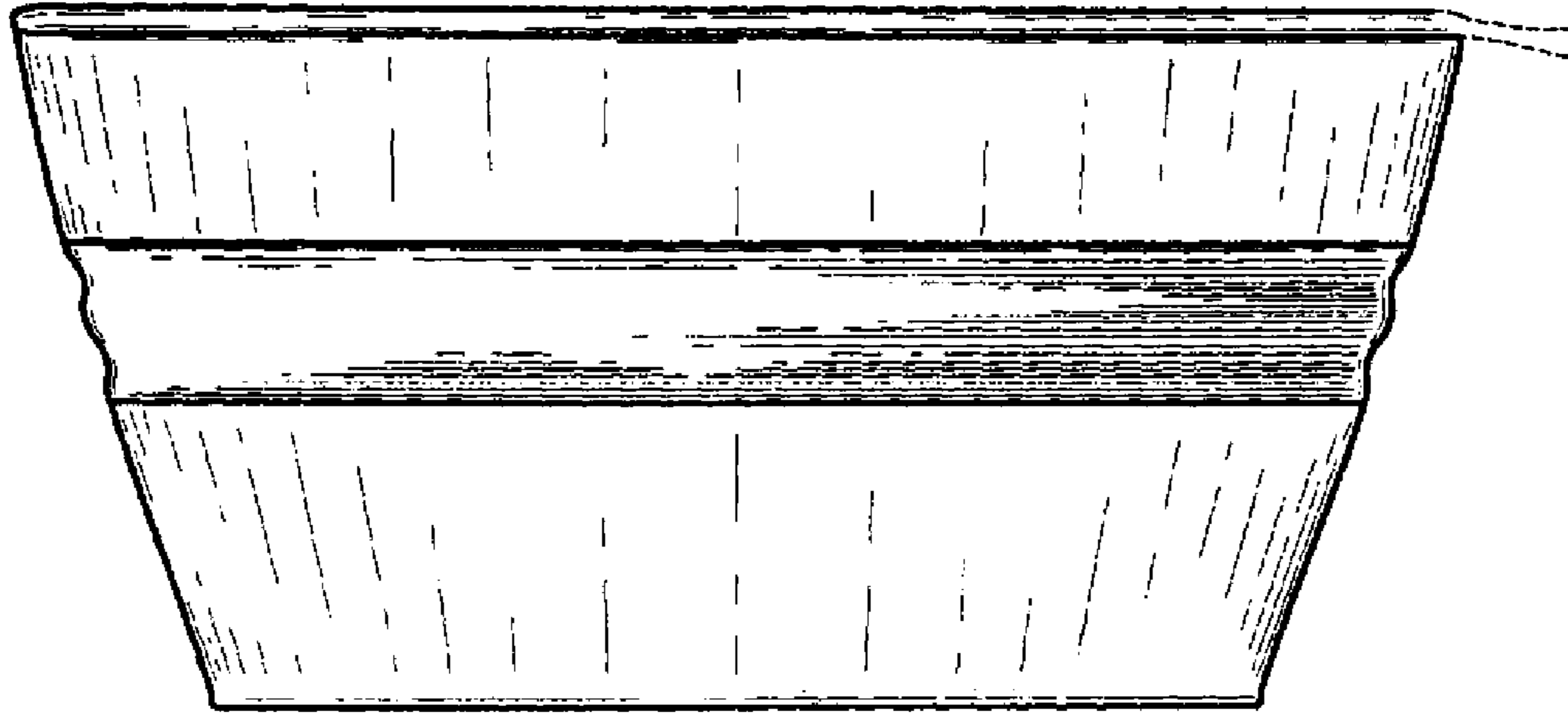
**1 Claim, 10 Drawing Sheets**



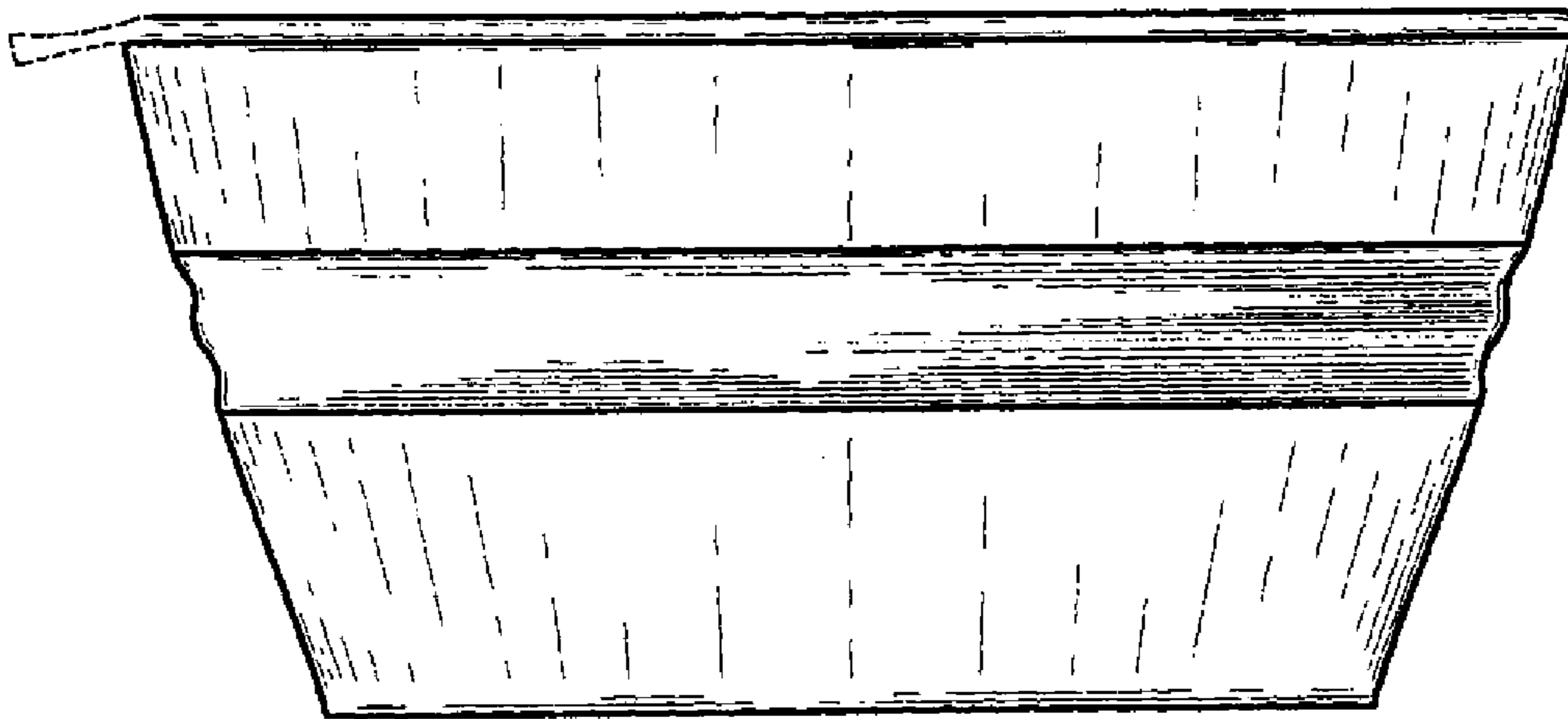




*Fig. 1*

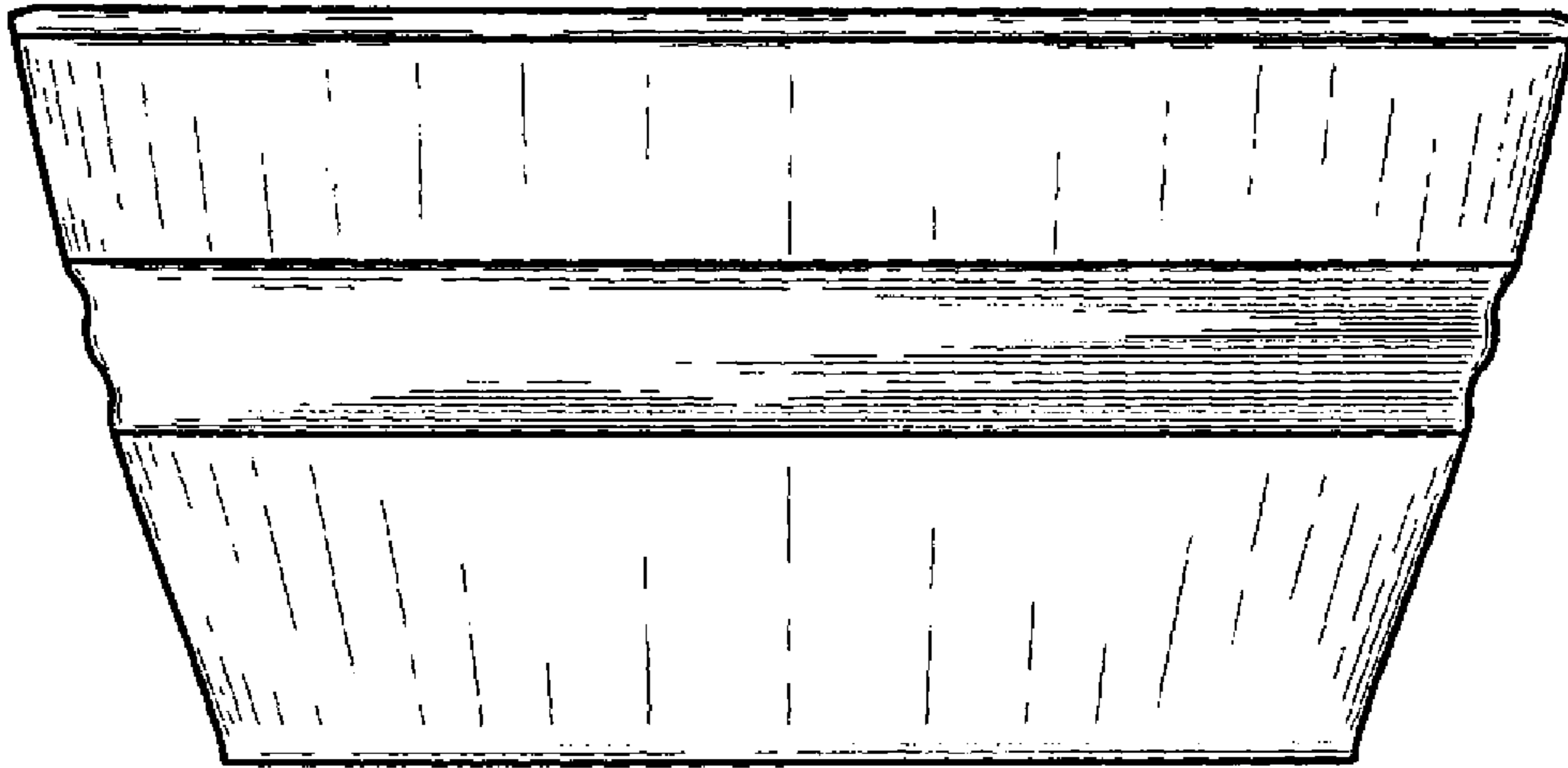


*Fig. 2*

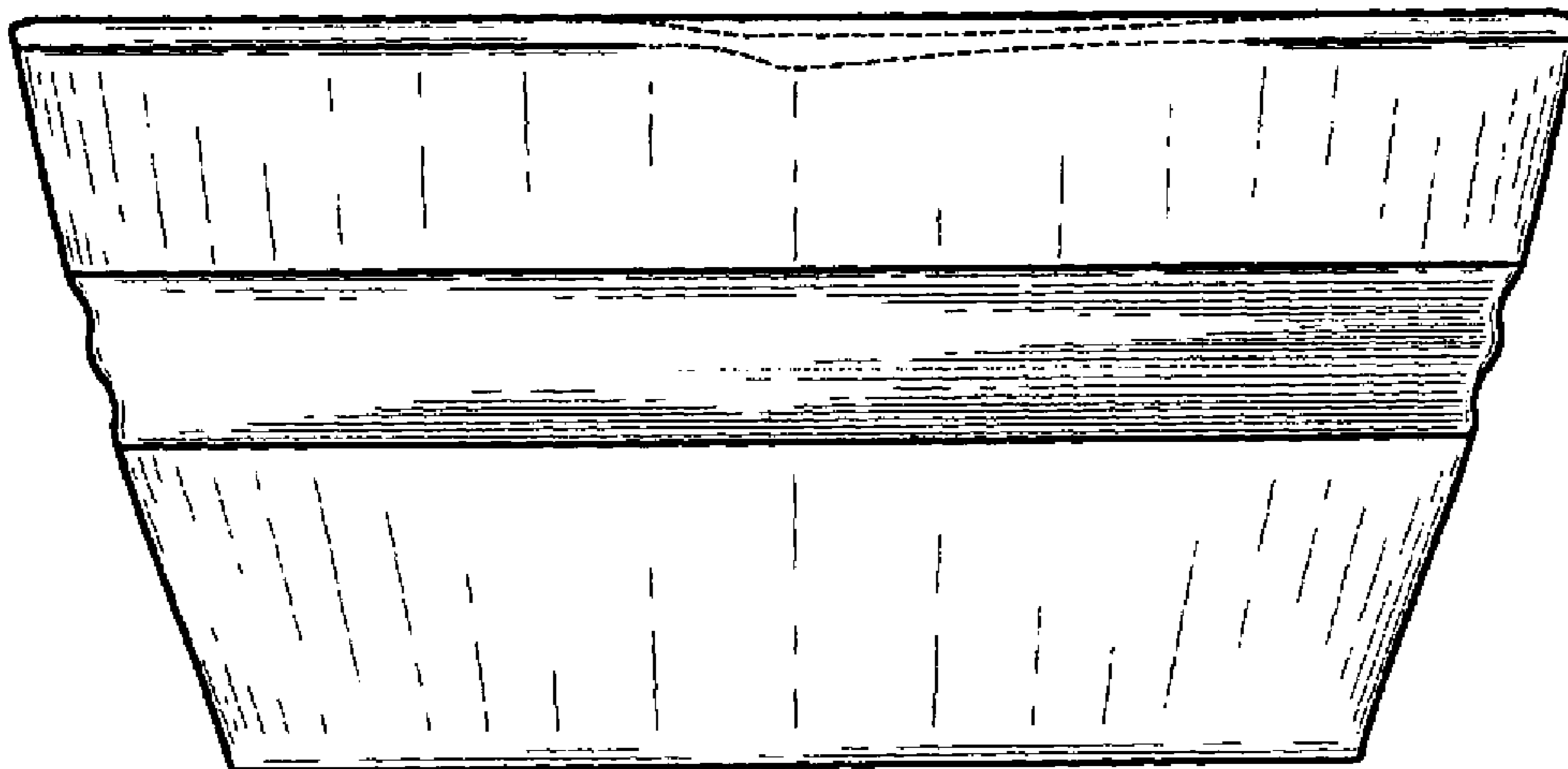


*Fig. 3*

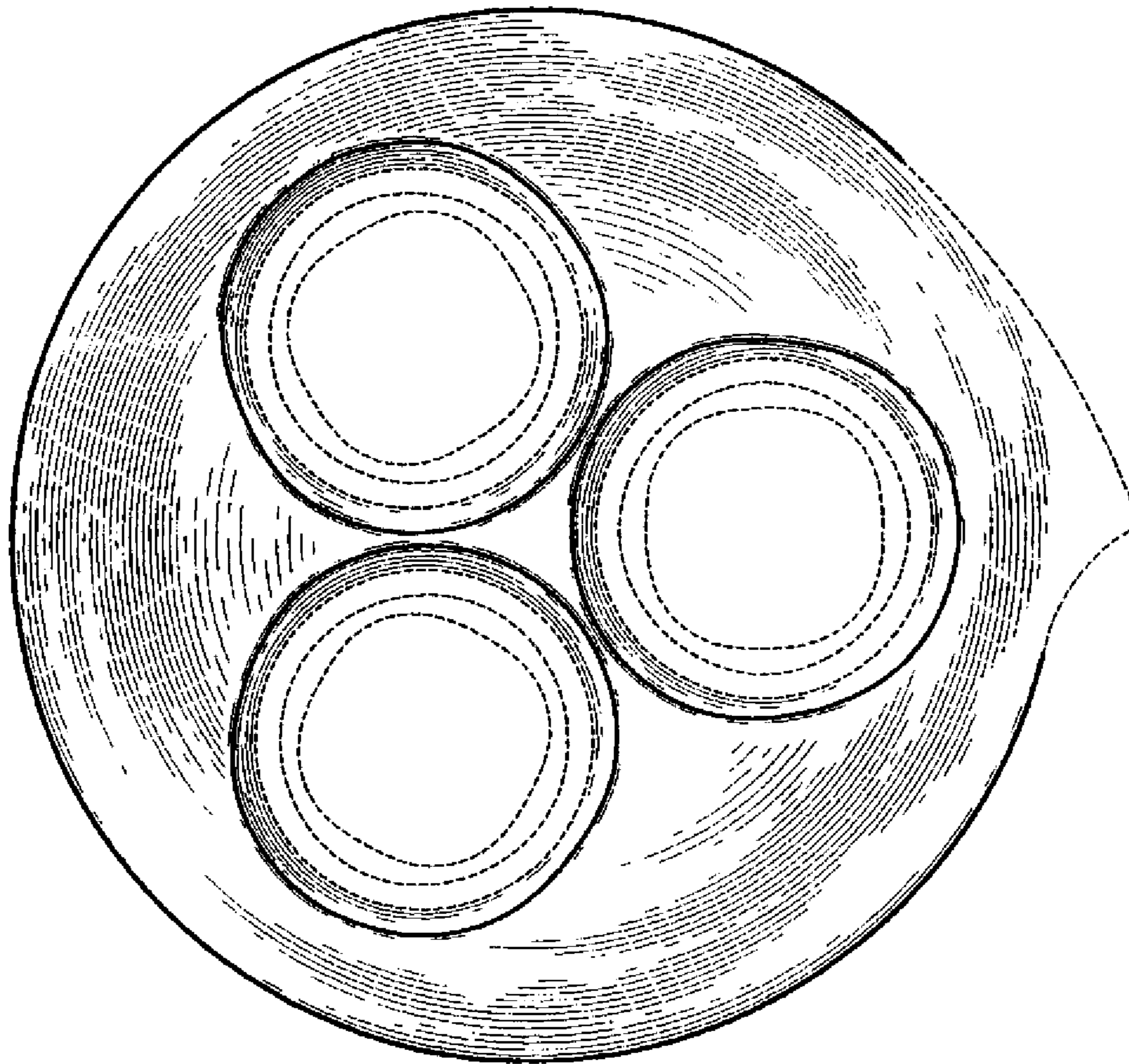




*Fig. 4*

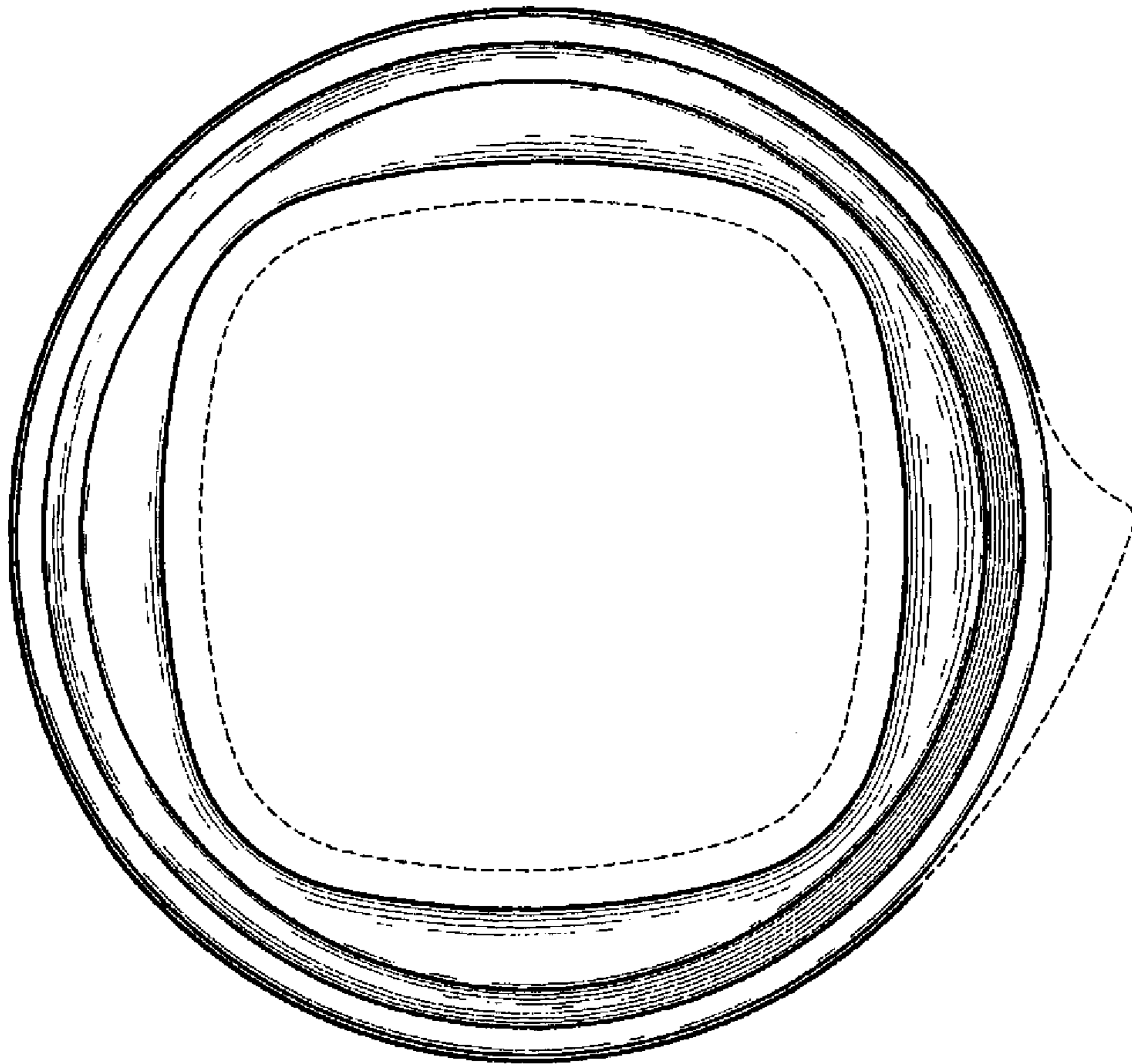


*Fig. 5*

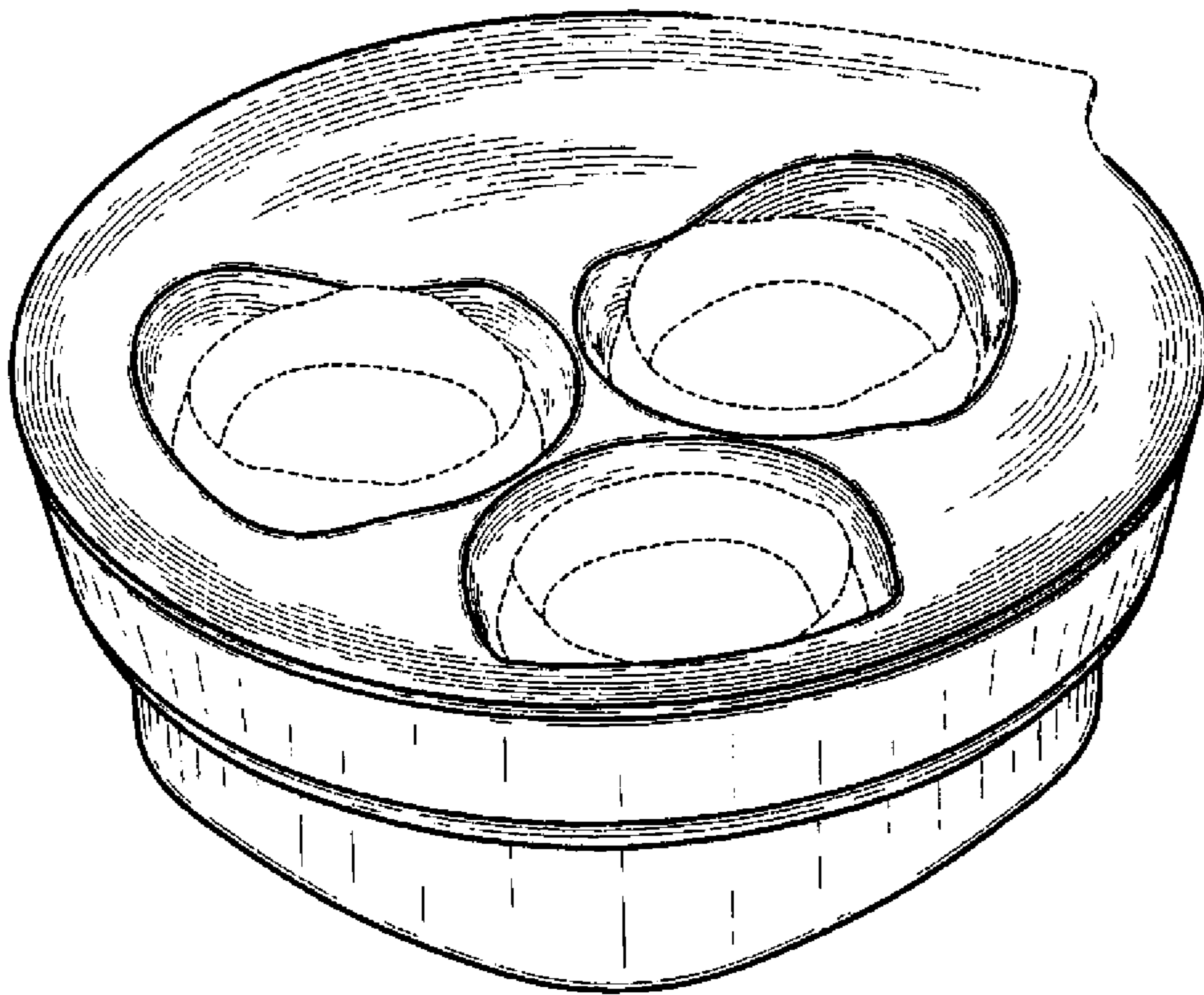


*Fig. 6*



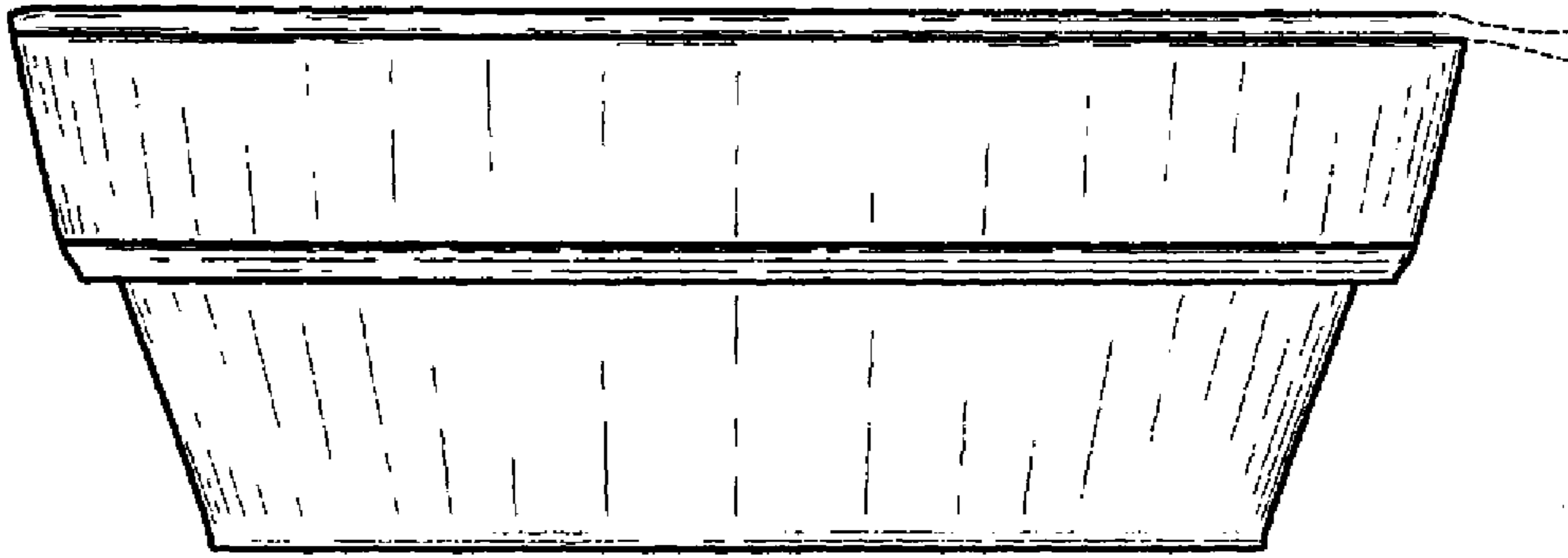


*Fig. 7*

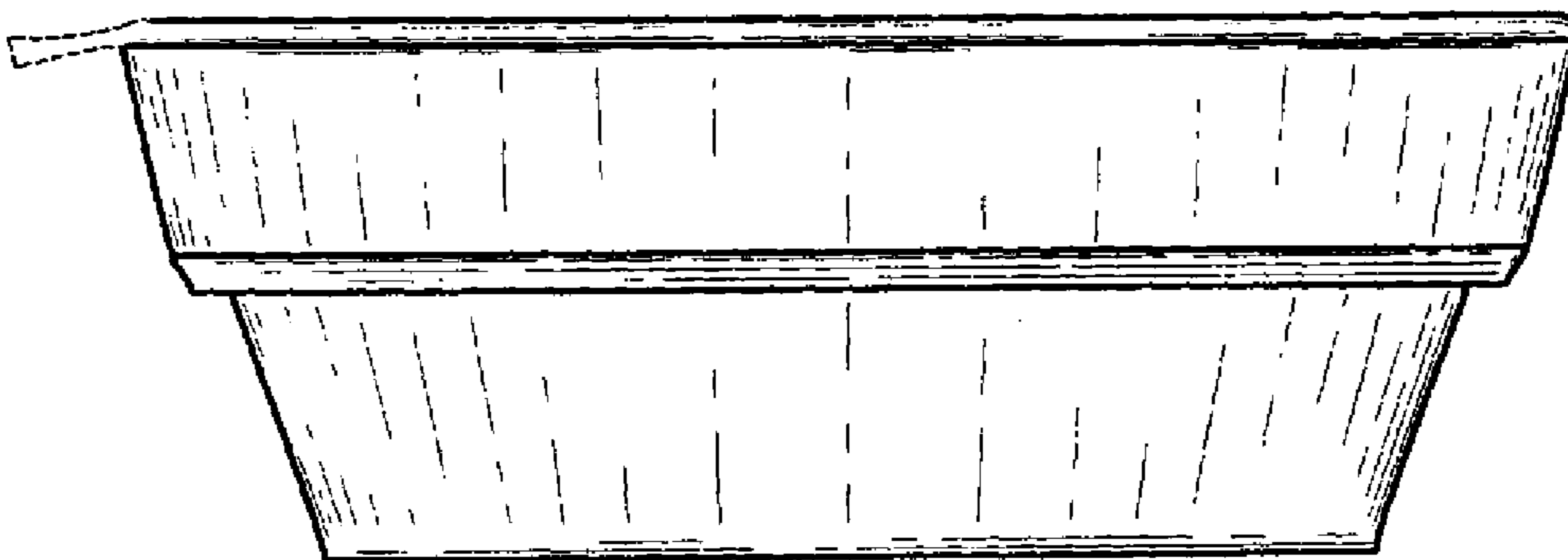


*Fig. 8*

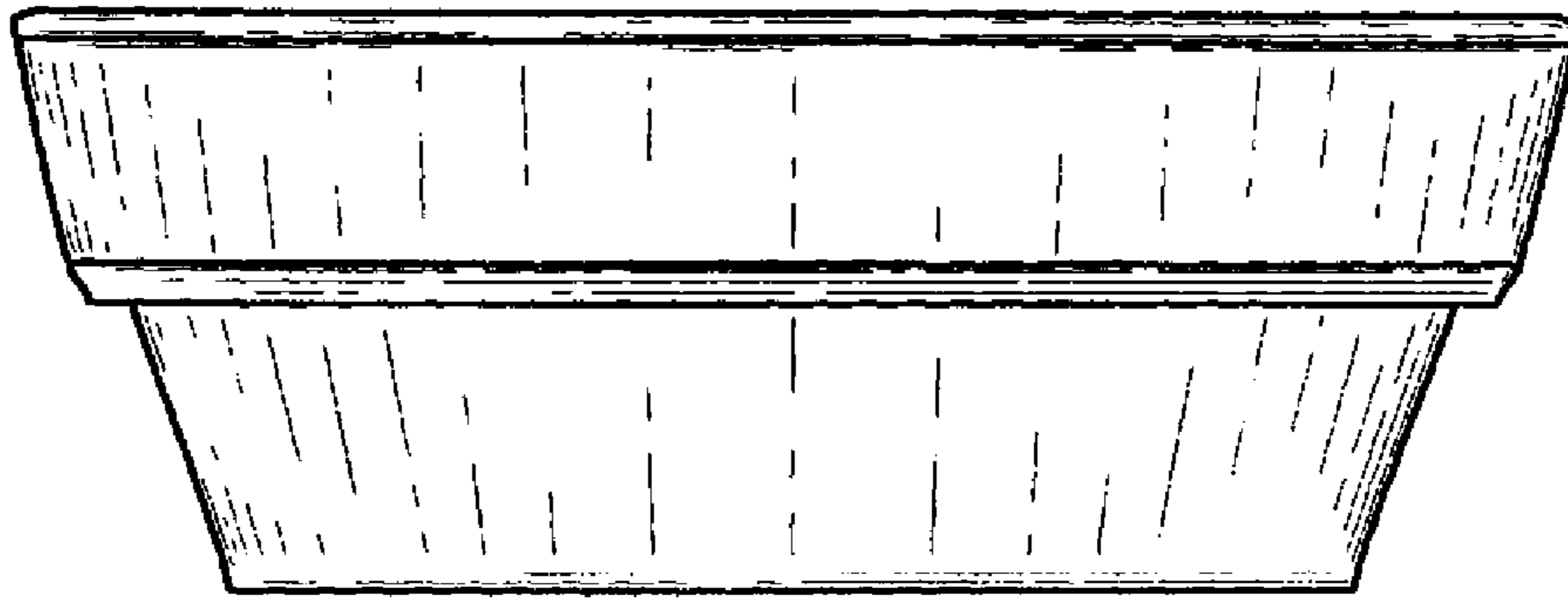




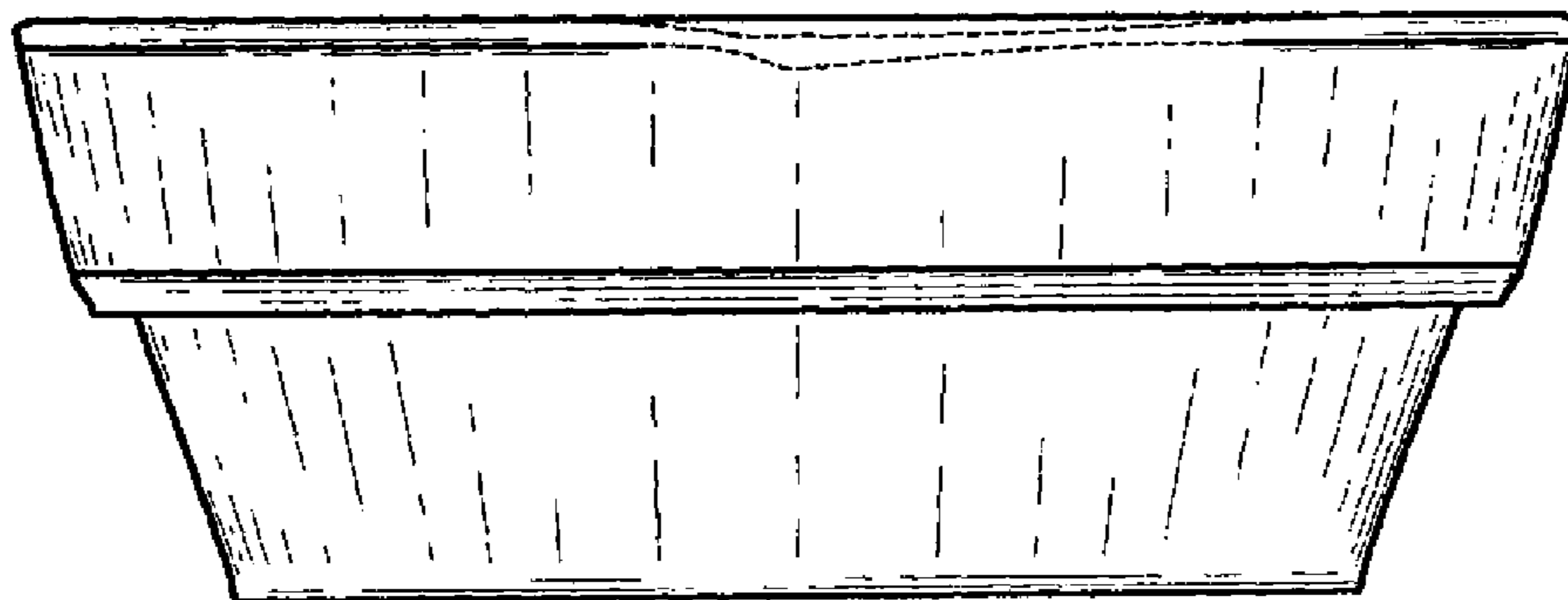
*Fig. 9*



*Fig. 10*

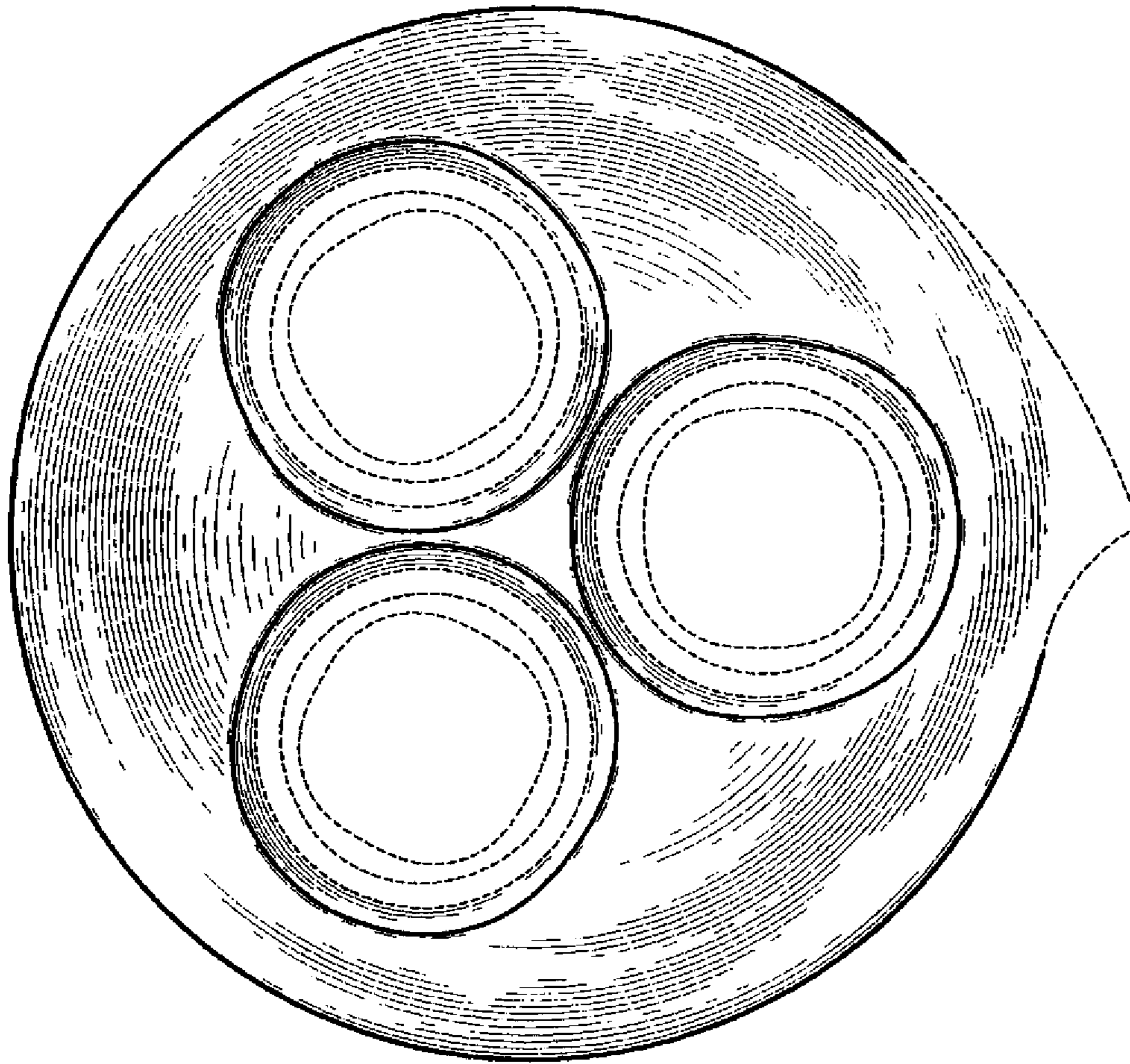


*Fig. 11*

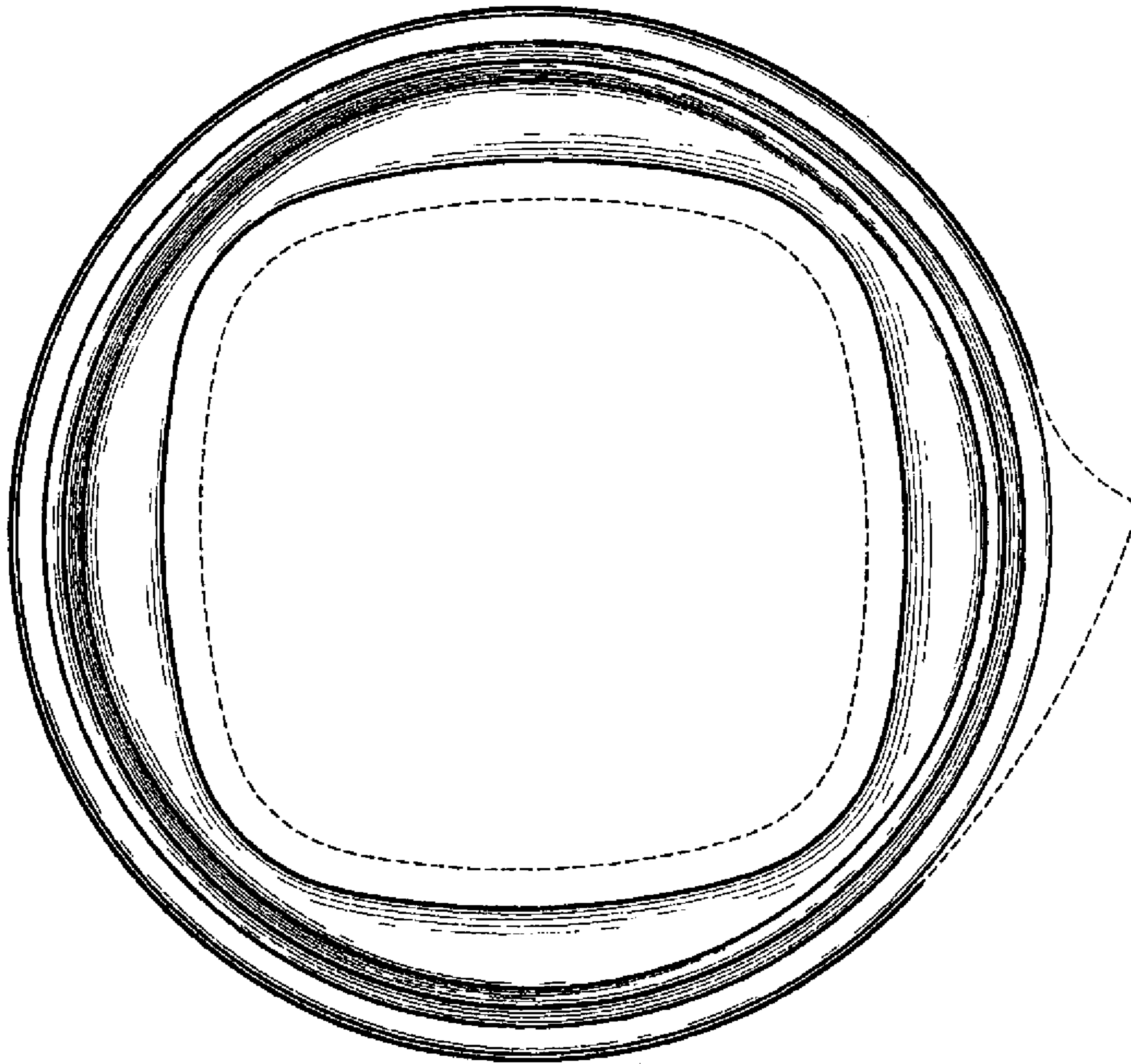


*Fig. 12*





*Fig. 13*



*Fig. 14*