



US00D661486S

(12) **United States Design Patent**
VanderVeer et al.

(10) **Patent No.:** **US D661,486 S**
(45) **Date of Patent:** **** Jun. 12, 2012**

(54) **HANDBAG WITH INTERCHANGEABLE DECORATIVE PANELS**

(76) Inventors: **Elizabeth VanderVeer**, Lake Oswego, OR (US); **Jasmine Fullman**, Beaverton, OR (US)

(**) Term: **14 Years**

(21) Appl. No.: **29/387,565**

(22) Filed: **Mar. 15, 2011**

(51) **LOC (9) Cl.** **03-01**

(52) **U.S. Cl.** **D3/233; D3/318**

(58) **Field of Classification Search** **D3/232–233, D3/240–245, 318; 150/100, 103–110, 113–114, 150/118–119**

See application file for complete search history.

(56) **References Cited**

U.S. PATENT DOCUMENTS

D488,925 S *	4/2004	McMahan et al.	D3/232
D566,384 S	4/2008	Yanz		
D613,947 S *	4/2010	Gibbons et al.	D3/318
D628,804 S *	12/2010	Gonzalez	D3/318
D635,355 S *	4/2011	Smith	D3/232
D638,627 S *	5/2011	Romero et al.	D3/318
D640,871 S *	7/2011	Romero et al.	D3/318

OTHER PUBLICATIONS

Case Logic, www.casellogic.com/17_laptop_messenger_bag/product_detail/index.cfm?modelid=201363&productid=10101107, accessed Jan. 27, 2011.

* cited by examiner

Primary Examiner — Holly Baynham

(74) *Attorney, Agent, or Firm* — Bert P. Krages, II

(57) **CLAIM**

We claim the ornamental design for a handbag with interchangeable decorative panels, as shown and described.

DESCRIPTION

FIG. 1 is a front view of the “handbag with interchangeable decorative panels” showing our new design;
 FIG. 2 is a front view of the handbag with interchangeable decorative panels shown in FIG. 1 showing a panel with a houndstooth design panel affixed to the flap of the handbag;
 FIG. 3 is an upper front exploded view of the handbag with interchangeable decorative panels shown in FIG. 1;
 FIG. 4 is a front view of the handbag with interchangeable decorative panels shown in FIG. 1 with the flap opened up;
 FIG. 5 is a top view of the handbag with interchangeable decorative panels shown in FIG. 1;
 FIG. 6 is a side view of the handbag with interchangeable decorative panels shown in FIG. 1;
 FIG. 7 is a side view of the handbag with interchangeable decorative panels shown in FIG. 1 showing the side opposite from the side depicted in FIG. 6;
 FIG. 8 is a bottom view of the handbag with interchangeable decorative panels shown in FIG. 1;
 FIG. 9 is a front view of an interchangeable decorative panel for the handbag shown in FIG. 1;
 FIG. 10 is a front view of an interchangeable decorative panel for the handbag shown in FIG. 1;
 FIG. 11 is a front view of an interchangeable decorative panel for the handbag shown in FIG. 1;
 FIG. 12 is a front view of an interchangeable decorative panel for the handbag shown in FIG. 1;
 FIG. 13 is a front view of an interchangeable decorative panel for the handbag shown in FIG. 1;
 FIG. 14 is a front view of an interchangeable decorative panel for the handbag shown in FIG. 1; and,
 FIG. 15 is a front view of an interchangeable decorative panel for the handbag shown in FIG. 1.
 The broken line showing of the strap is for the purpose of illustrating a portion of the article and forms no part of the claimed design.

1 Claim, 7 Drawing Sheets

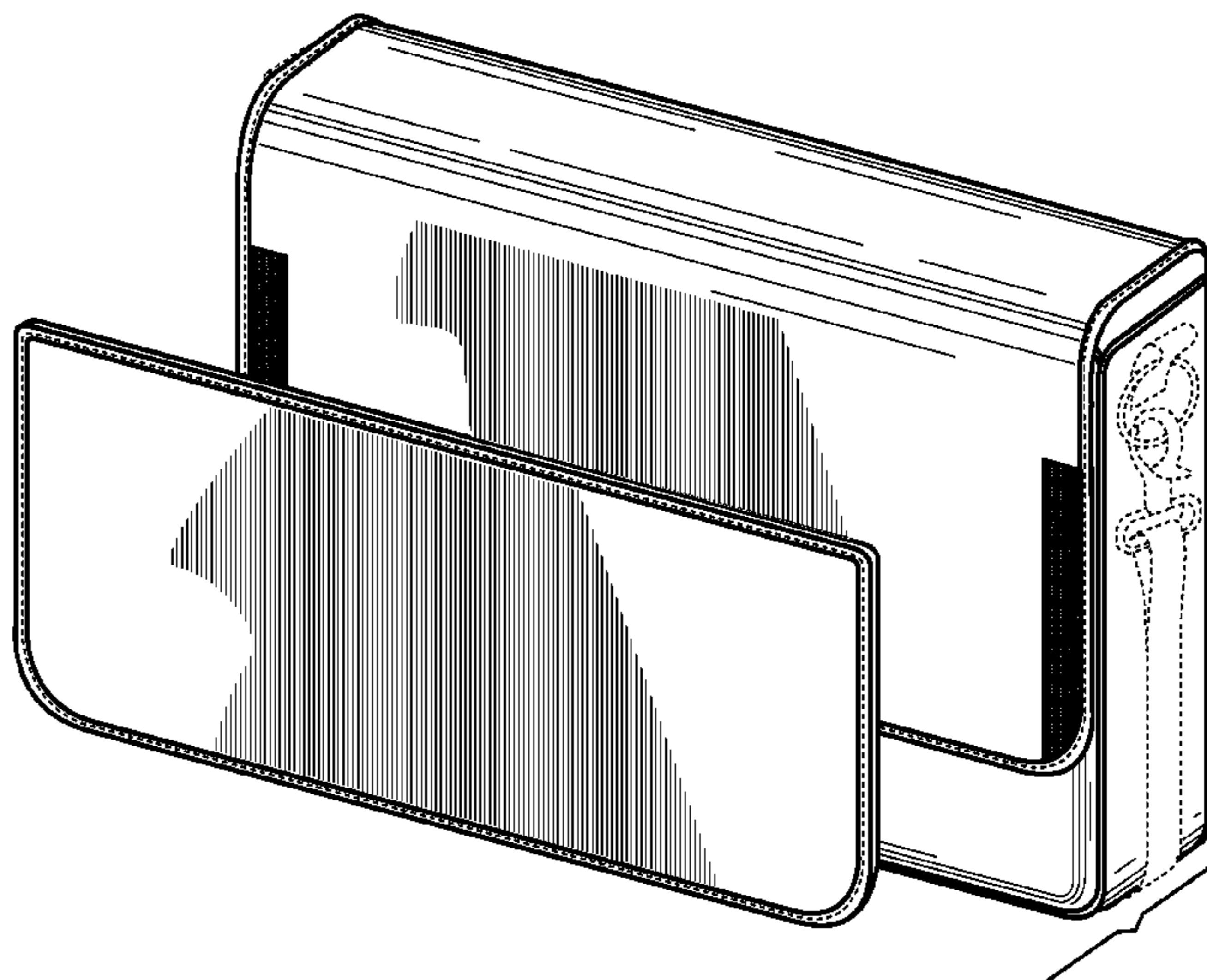
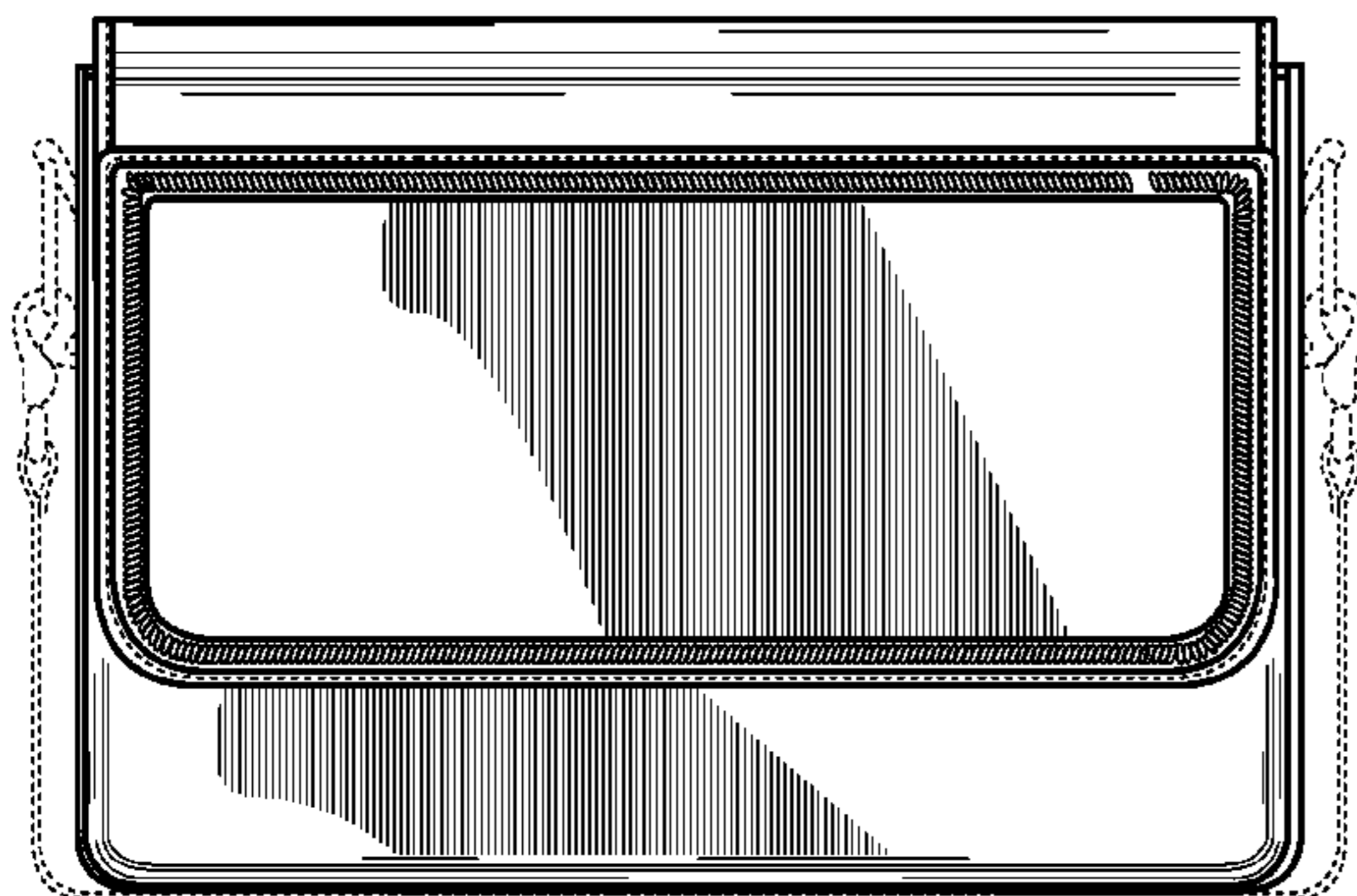

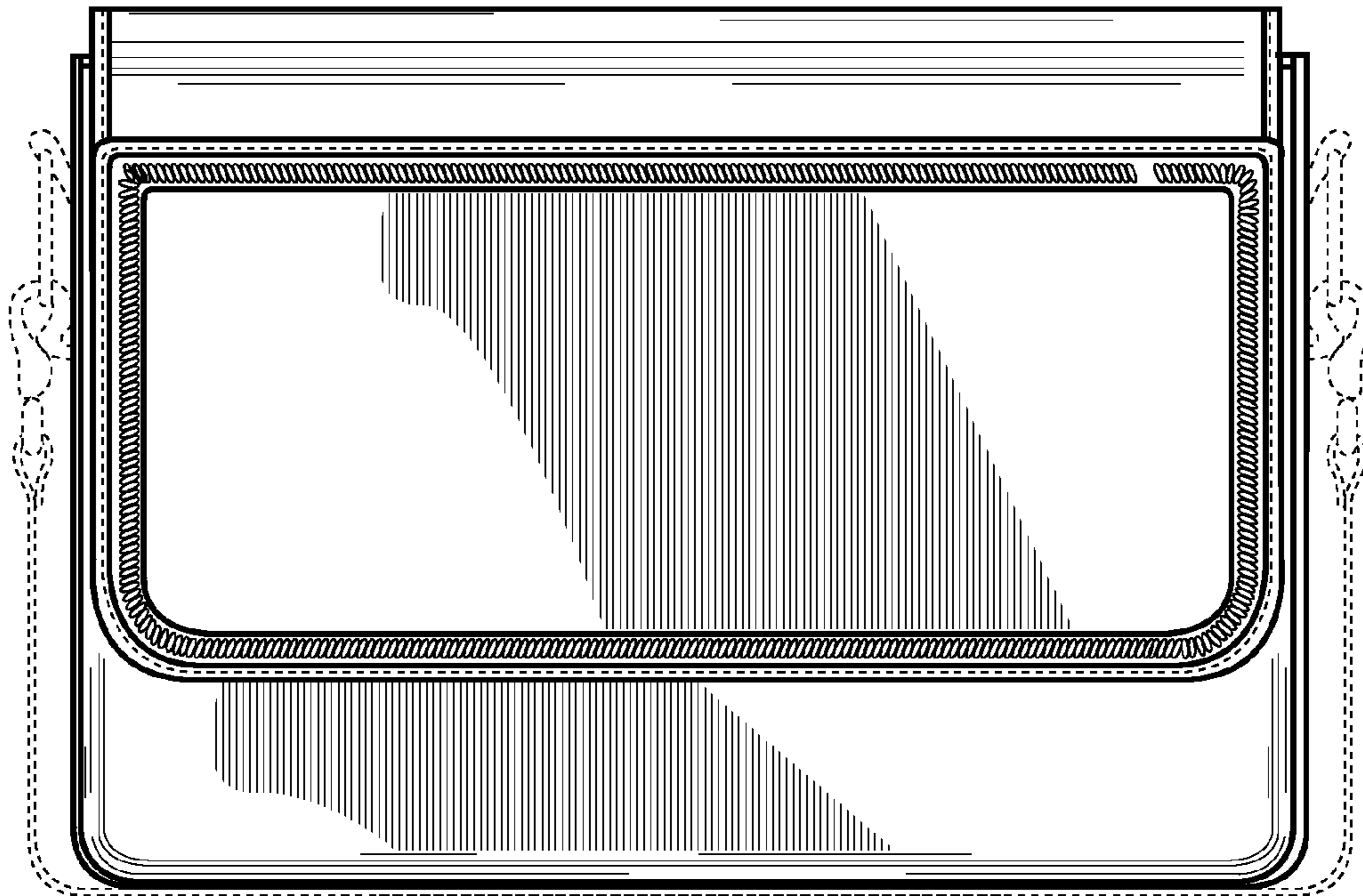

FIG. 1

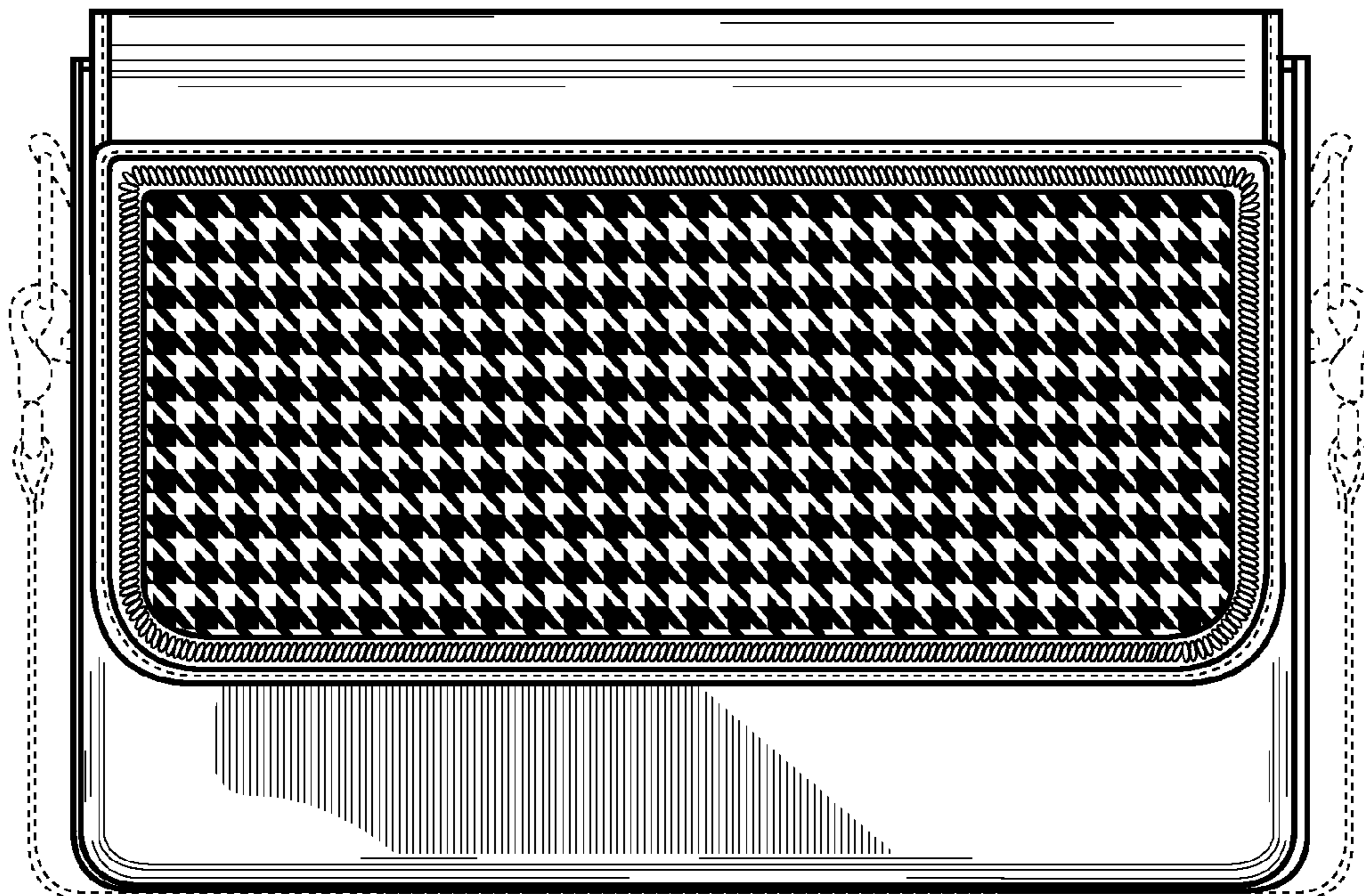

FIG. 2

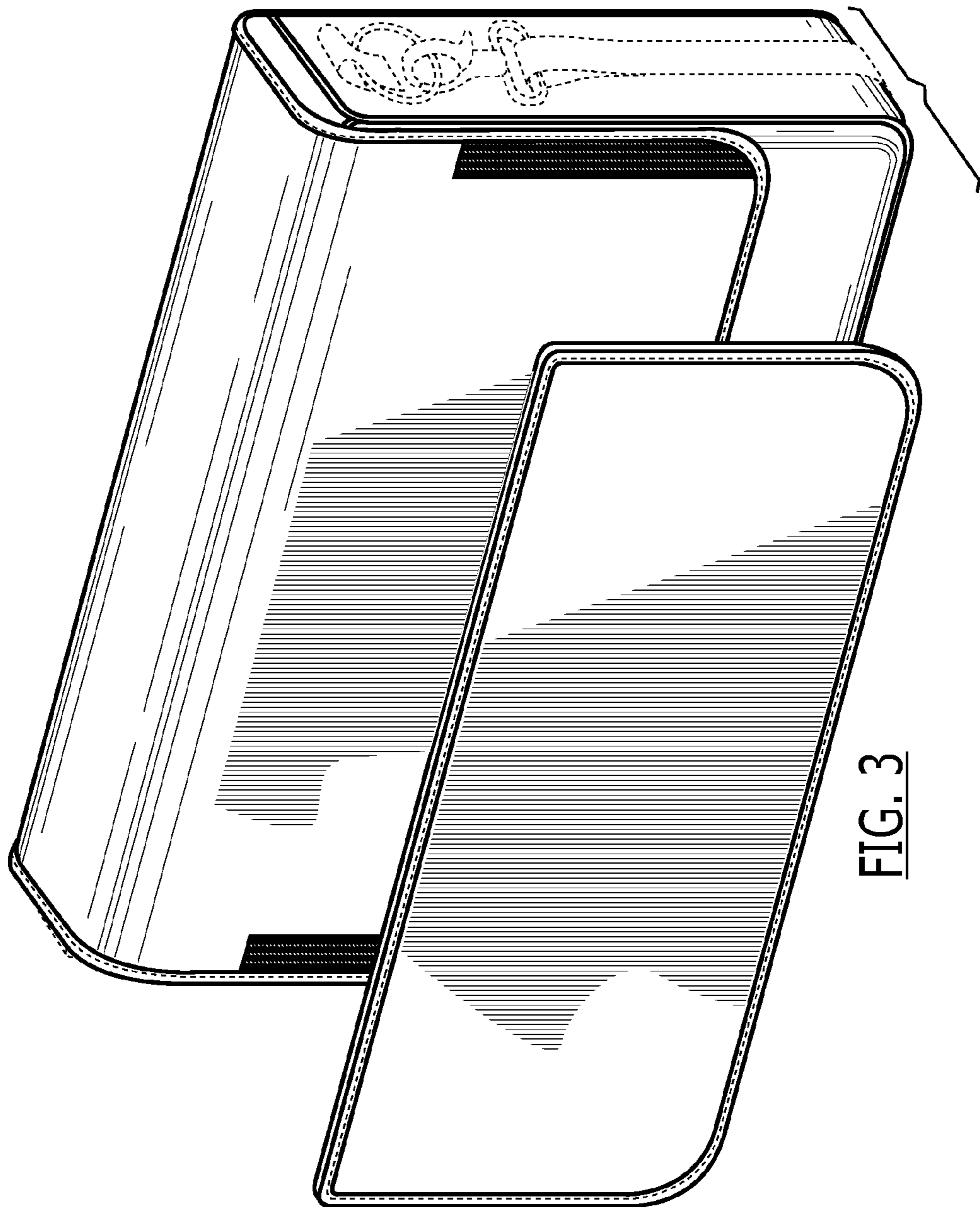

FIG. 3

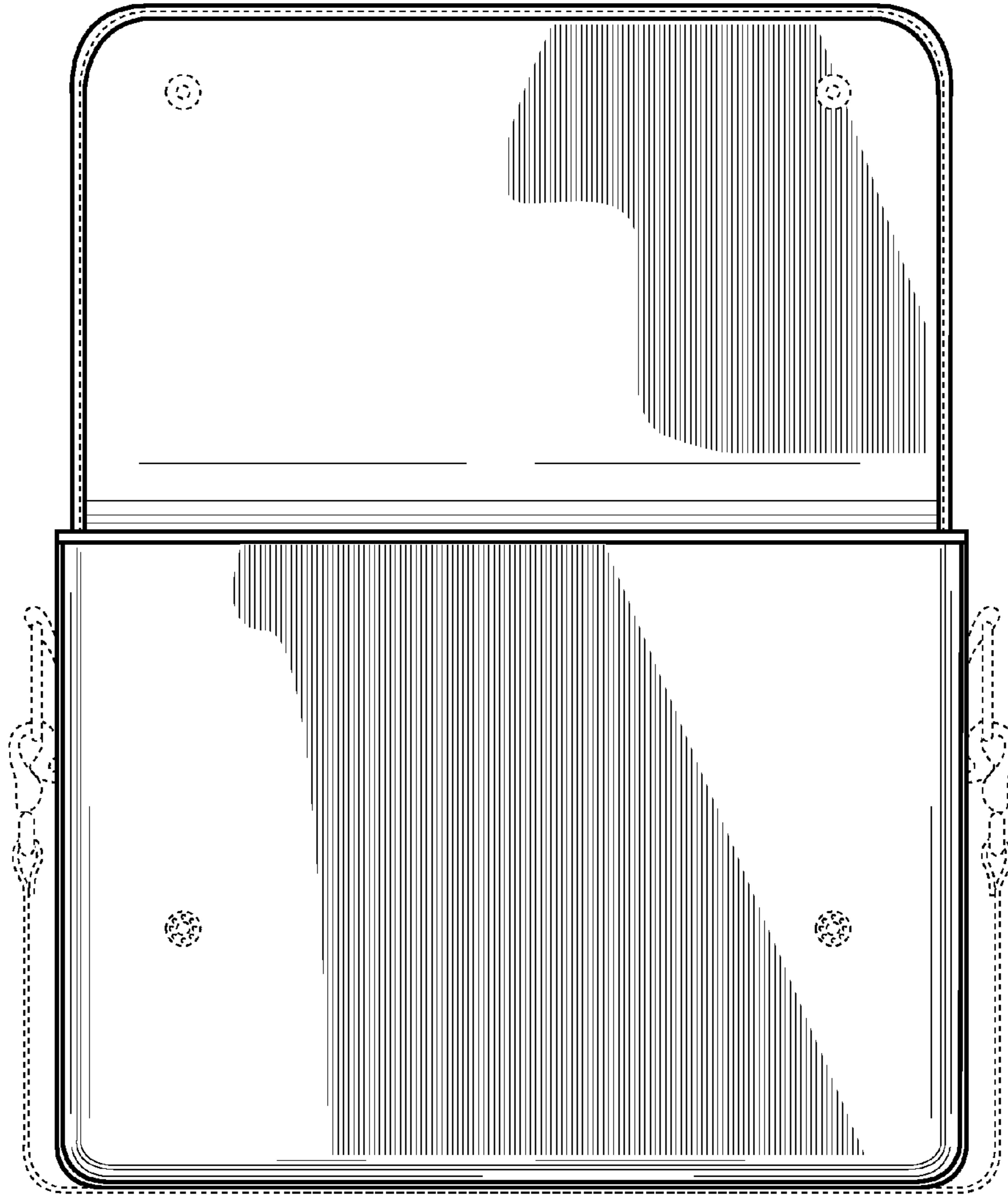

FIG. 4

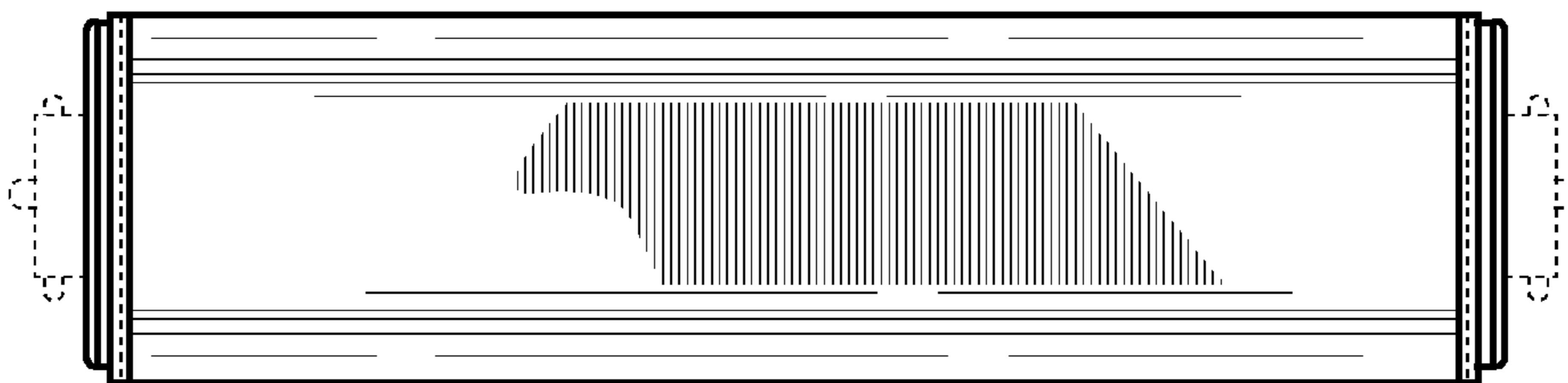

FIG. 5

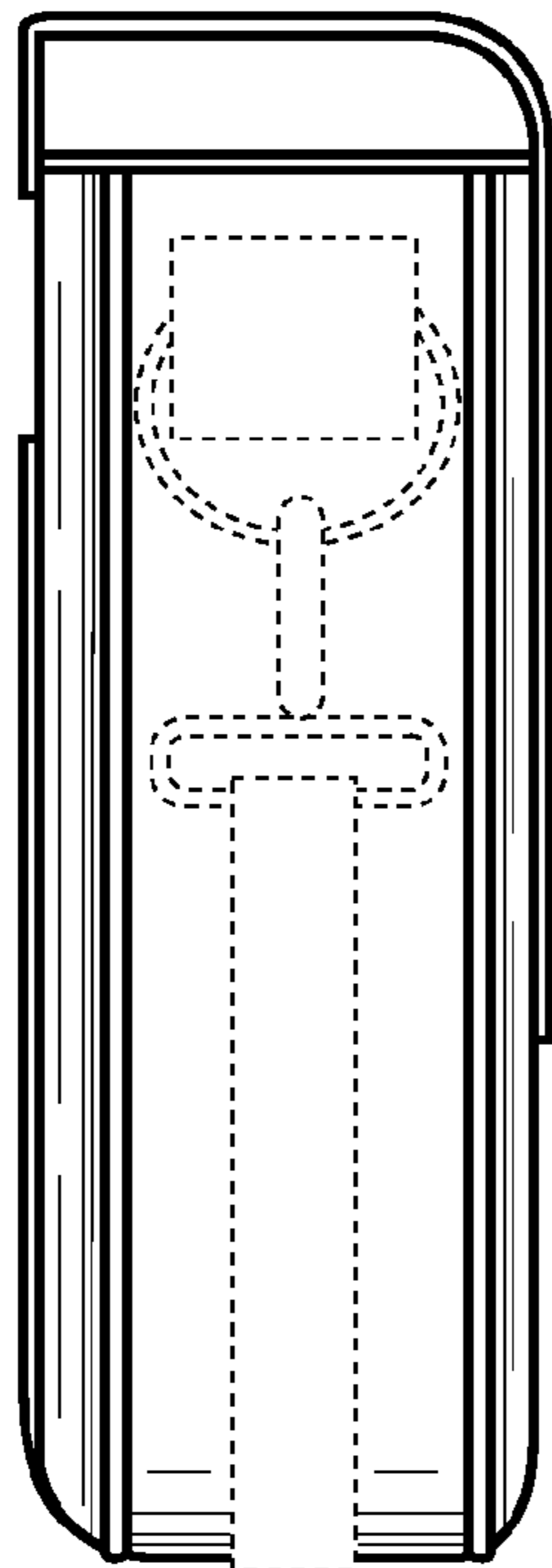

FIG. 6

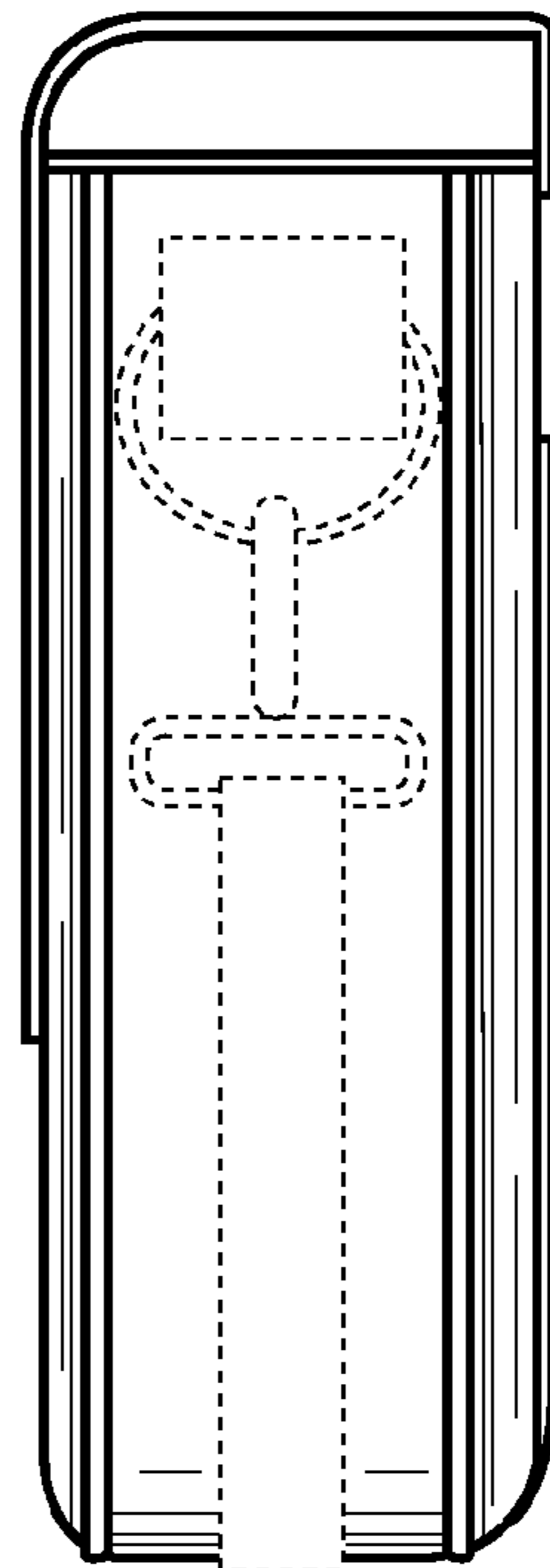

FIG. 7

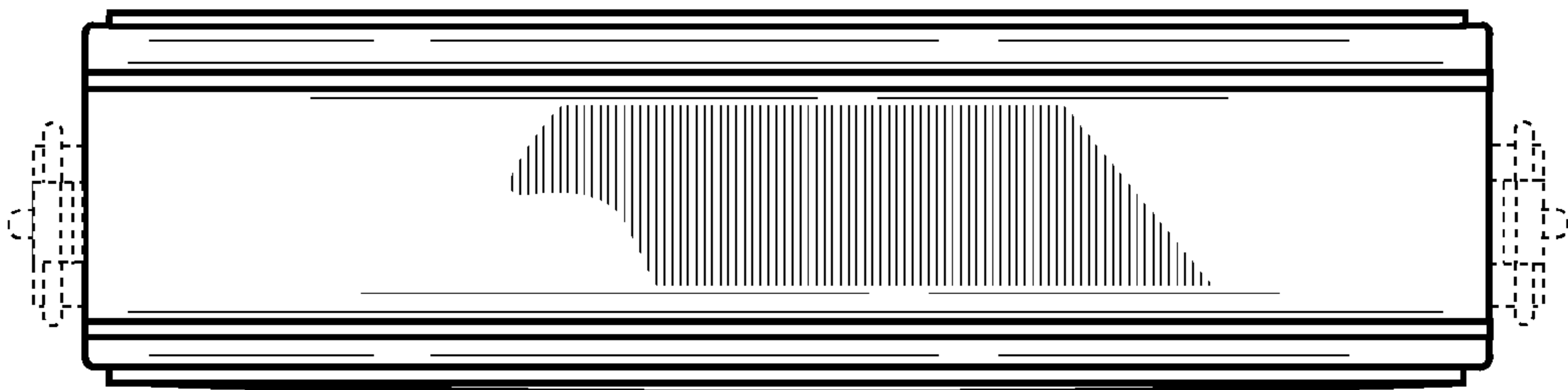

FIG. 8

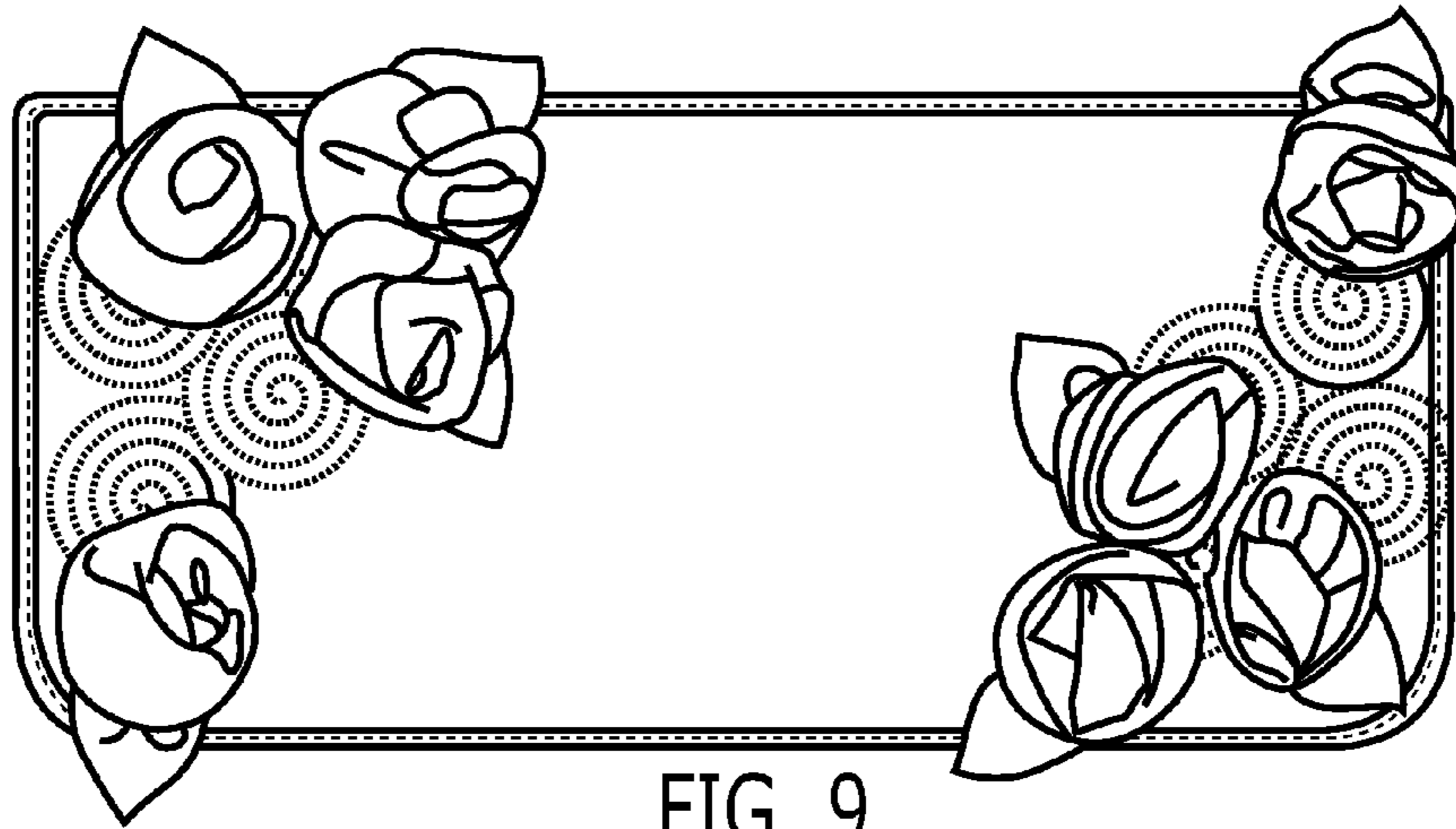

FIG. 9



FIG. 10

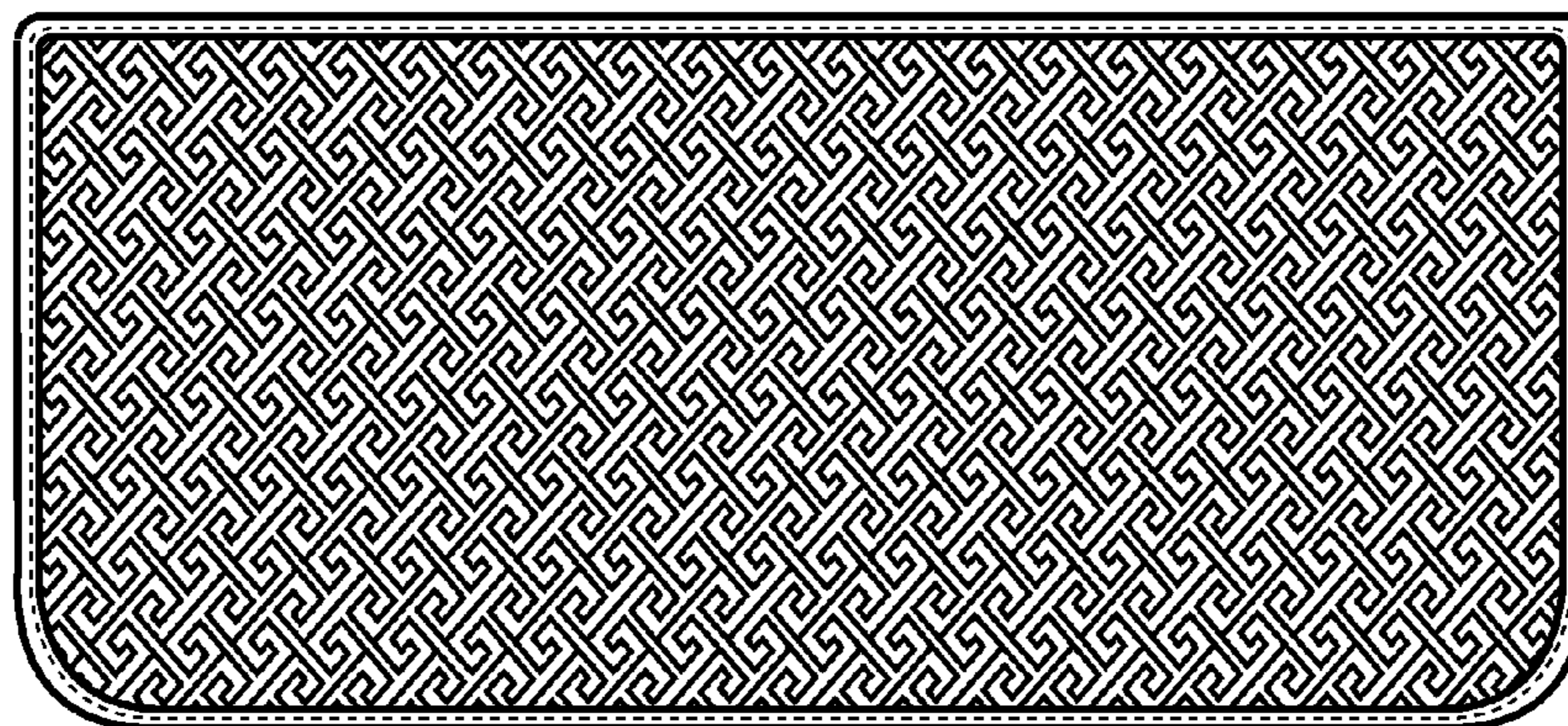

FIG. 11



FIG. 12



FIG. 13

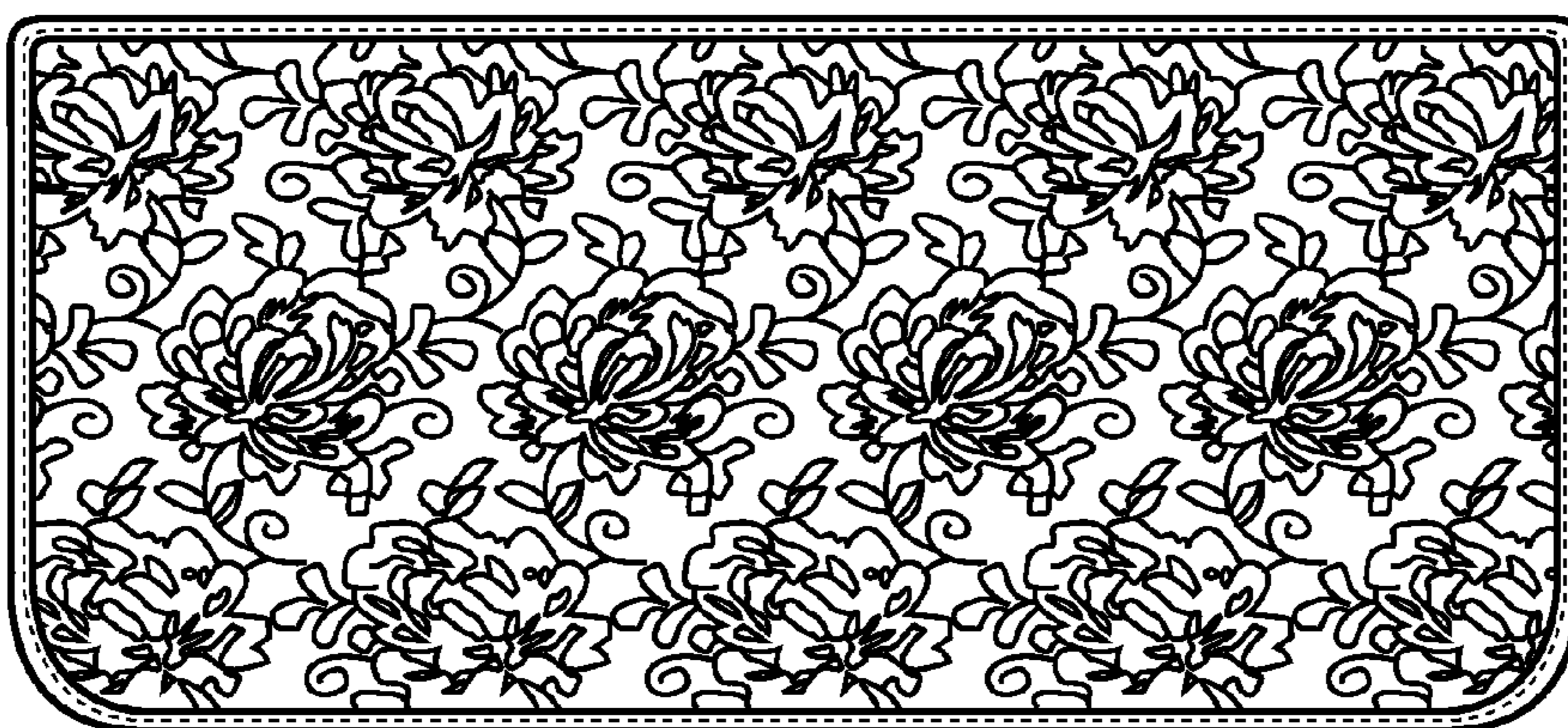

FIG. 14

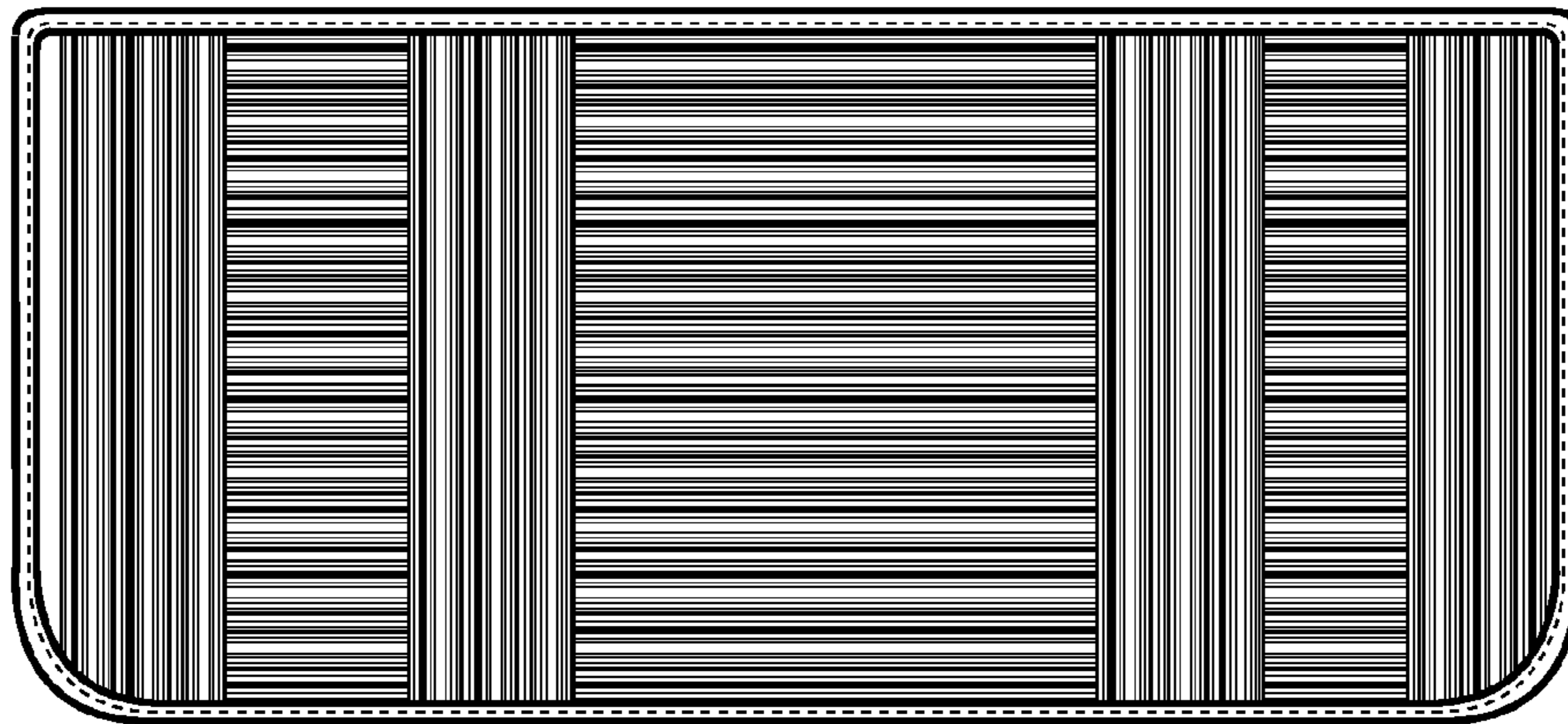

FIG. 15