

US00D661410S

(12) **United States Design Patent**
Ryan

(10) **Patent No.:** **US D661,410 S**
(45) **Date of Patent:** **** Jun. 5, 2012**

(54) **ACOUSTICAL ROOF DECK**
(75) Inventor: **Thomas G. Ryan**, North Huntingdon,
PA (US)
(73) Assignee: **Epic Metals Corporation**, Rankin, PA
(US)
(**) Term: **14 Years**
(21) Appl. No.: **29/383,763**

6,357,191 B1 3/2002 Ault et al.
6,691,482 B1 2/2004 Ault
6,813,864 B2 11/2004 Landis
D507,665 S 7/2005 Ryan et al.
D511,580 S 11/2005 Ryan et al.
7,146,920 B1 12/2006 Ryan et al.
D552,765 S 10/2007 Ault et al.
7,328,667 B1 2/2008 Ryan et al.
7,418,807 B1 9/2008 Ryan et al.
D608,464 S 1/2010 Ryan
D622,417 S 8/2010 Ryan
D623,773 S 9/2010 Ryan

(22) Filed: **Jan. 21, 2011**
(51) **LOC (9) Cl.** **25-01**
(52) **U.S. Cl.** **D25/121**
(58) **Field of Classification Search** D25/120,
D25/121, 158, 153; 52/182, 177, 180, 650.3,
52/674, 87
See application file for complete search history.

OTHER PUBLICATIONS

Bowman Metal Deck publication, Cyclops Corporation, 1987.

* cited by examiner

Primary Examiner — Doris Clark
(74) *Attorney, Agent, or Firm* — The Webb Law Firm

(56) **References Cited**

(57) **CLAIM**
The ornamental design for acoustical roof deck, as shown and described.

U.S. PATENT DOCUMENTS

DESCRIPTION

2,148,496	A *	2/1939	Park	52/145
3,707,088	A	12/1972	King et al.	
3,713,261	A	1/1973	Landis et al.	
D238,898	S	2/1976	Landis et al.	
3,967,426	A	7/1976	Ault et al.	
4,085,558	A	4/1978	Albrecht	
4,453,349	A *	6/1984	Ryan	52/630
4,454,692	A	6/1984	Ault	
4,507,900	A	4/1985	Landis	
4,685,264	A	8/1987	Landis	
4,695,033	A	9/1987	Imaeda et al.	
5,172,527	A	12/1992	Ault	
5,205,098	A	4/1993	Landis et al.	
D337,169	S	7/1993	Schipp	
5,259,157	A	11/1993	Ault	
5,491,946	A	2/1996	Landis et al.	
5,566,522	A	10/1996	Alander et al.	
D441,876	S	5/2001	Eaton	
D443,368	S	6/2001	Eaton	

FIG. 1 is a perspective view of the acoustical roof deck;
FIG. 2 is a top plan view thereof;
FIG. 3 is a bottom plan view thereof;
FIG. 4 is a left side elevational view thereof;
FIG. 5 is a right side elevational view thereof;
FIG. 6 is a front elevational view thereof;
FIG. 7 is a rear elevational view thereof; and,
FIG. 8 is a perspective view thereof, showing the environment
of the acoustical roof deck.
The broken lines in the drawings are included for the purpose
of illustrating environment and form no part of the claimed
design. In FIGS. 1-5 and 8, the acoustical roof deck has been
broken in the center to indicate indefinite length.

1 Claim, 8 Drawing Sheets

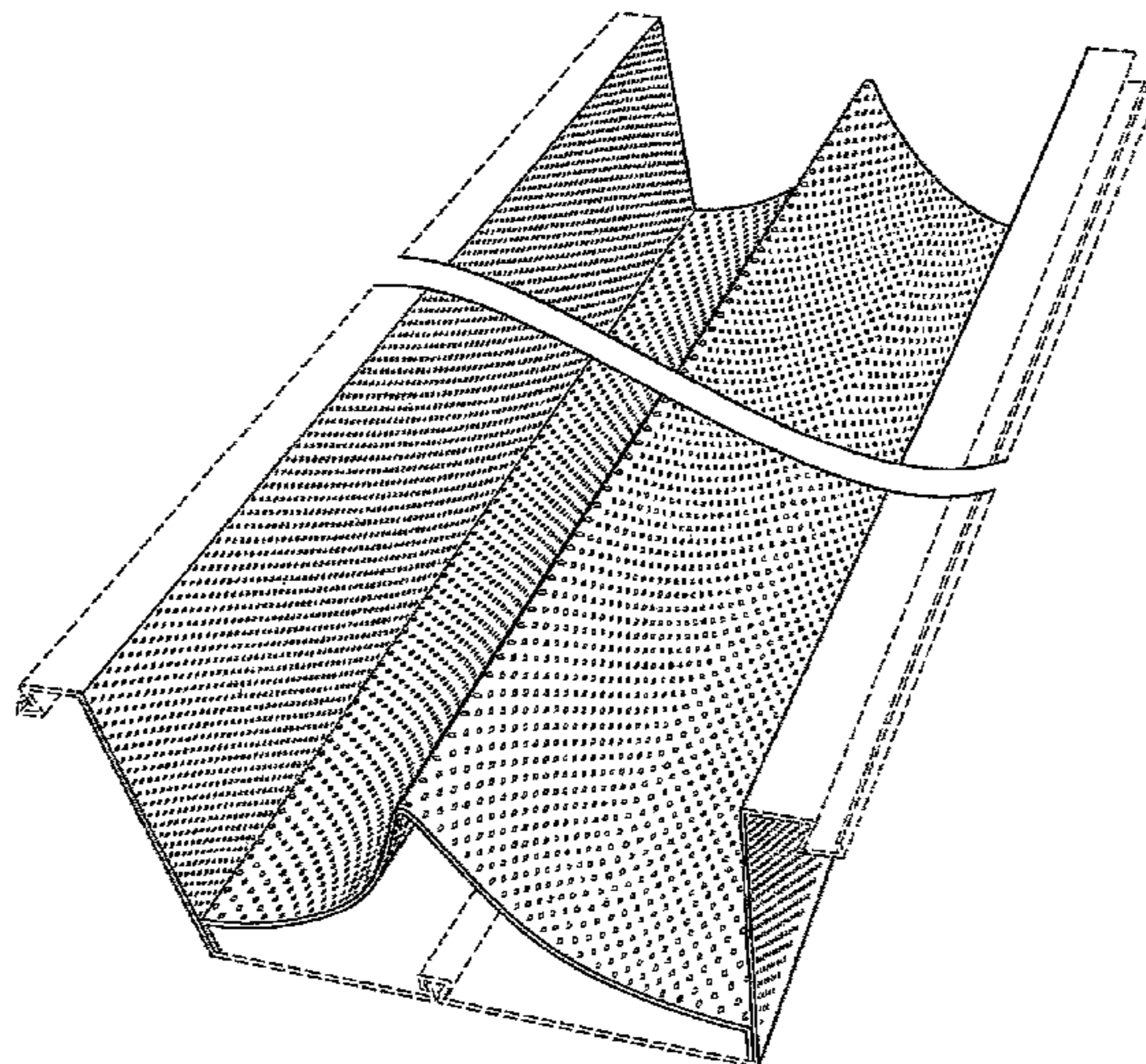

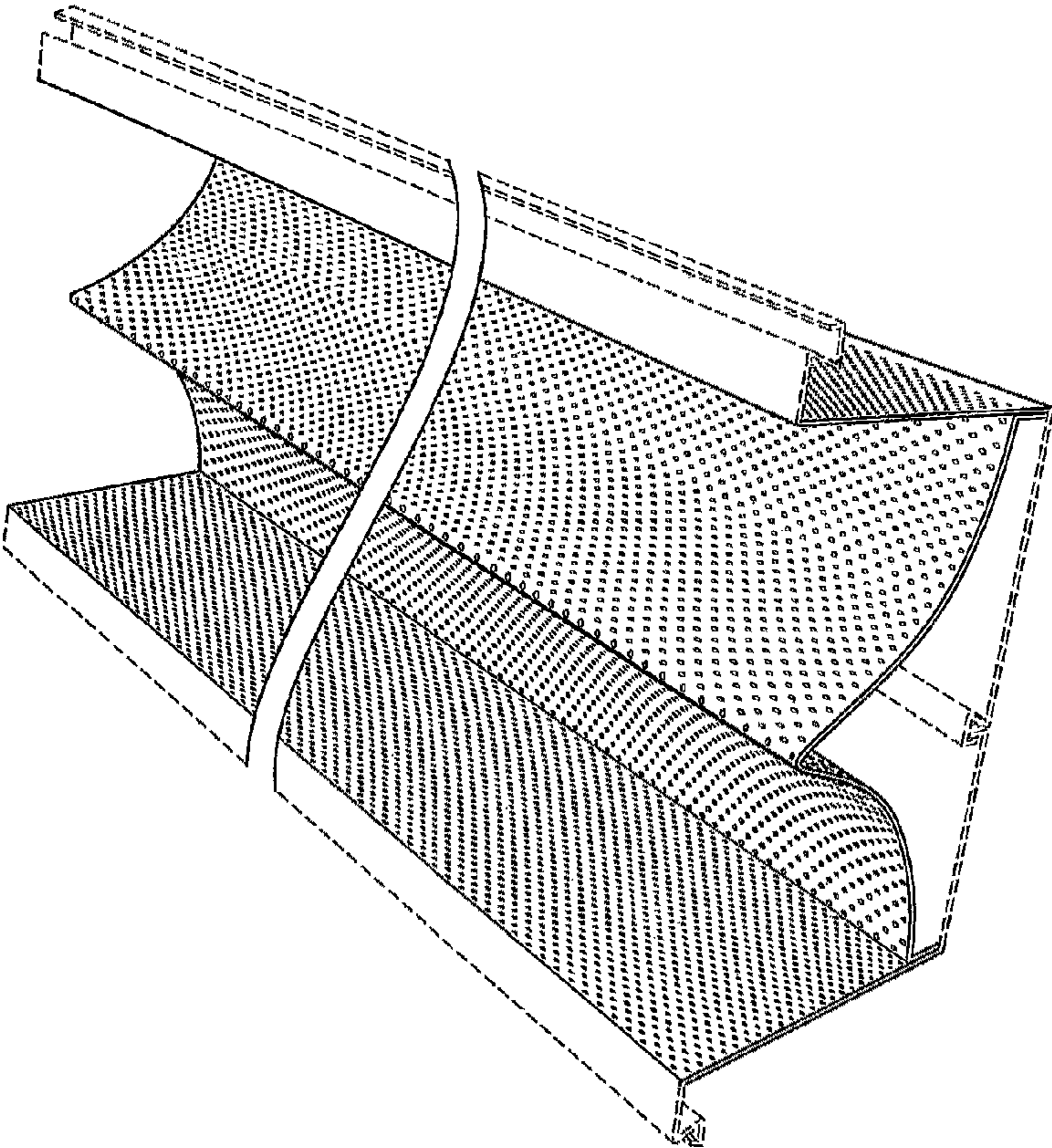

FIG. 1

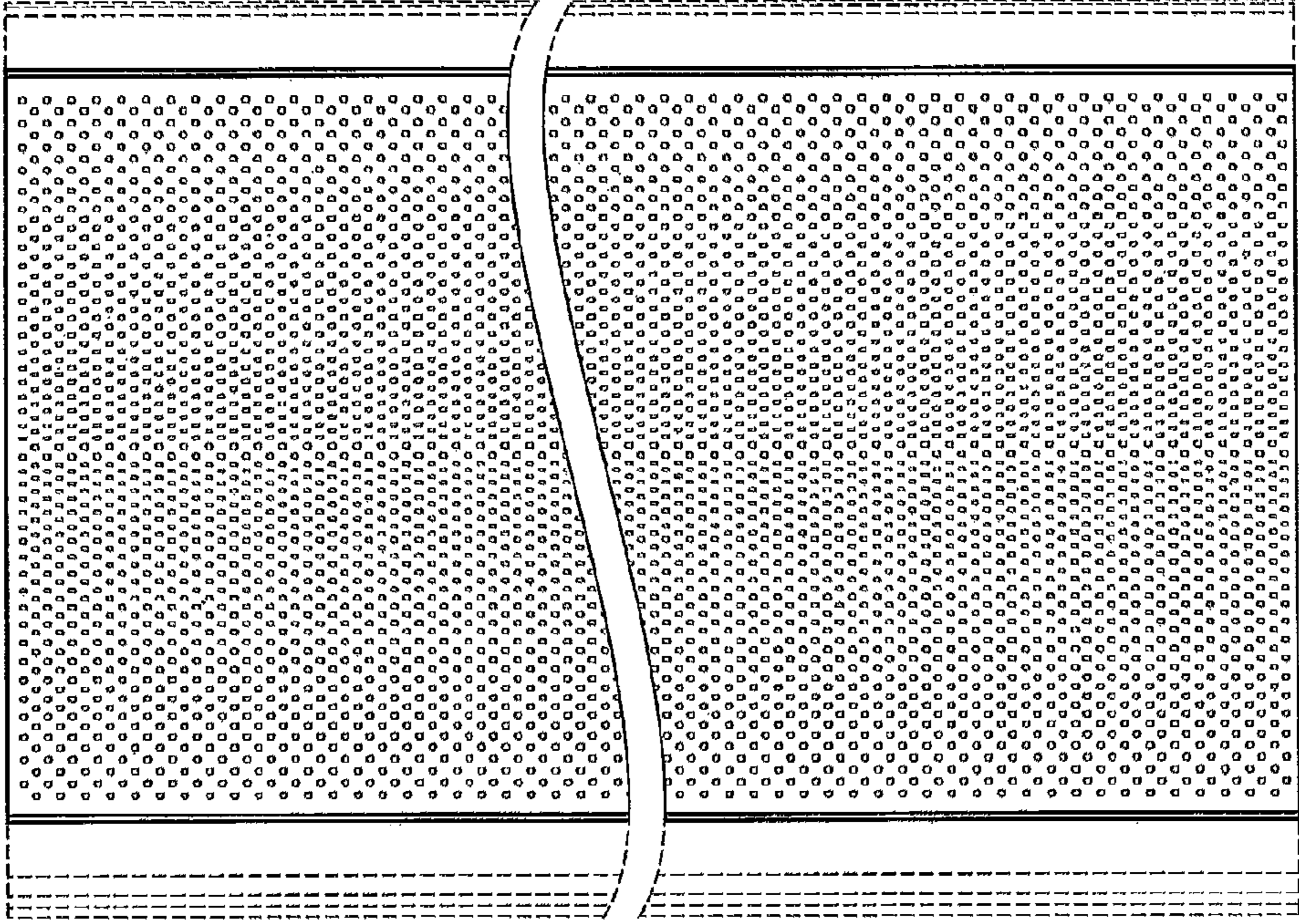

FIG. 2

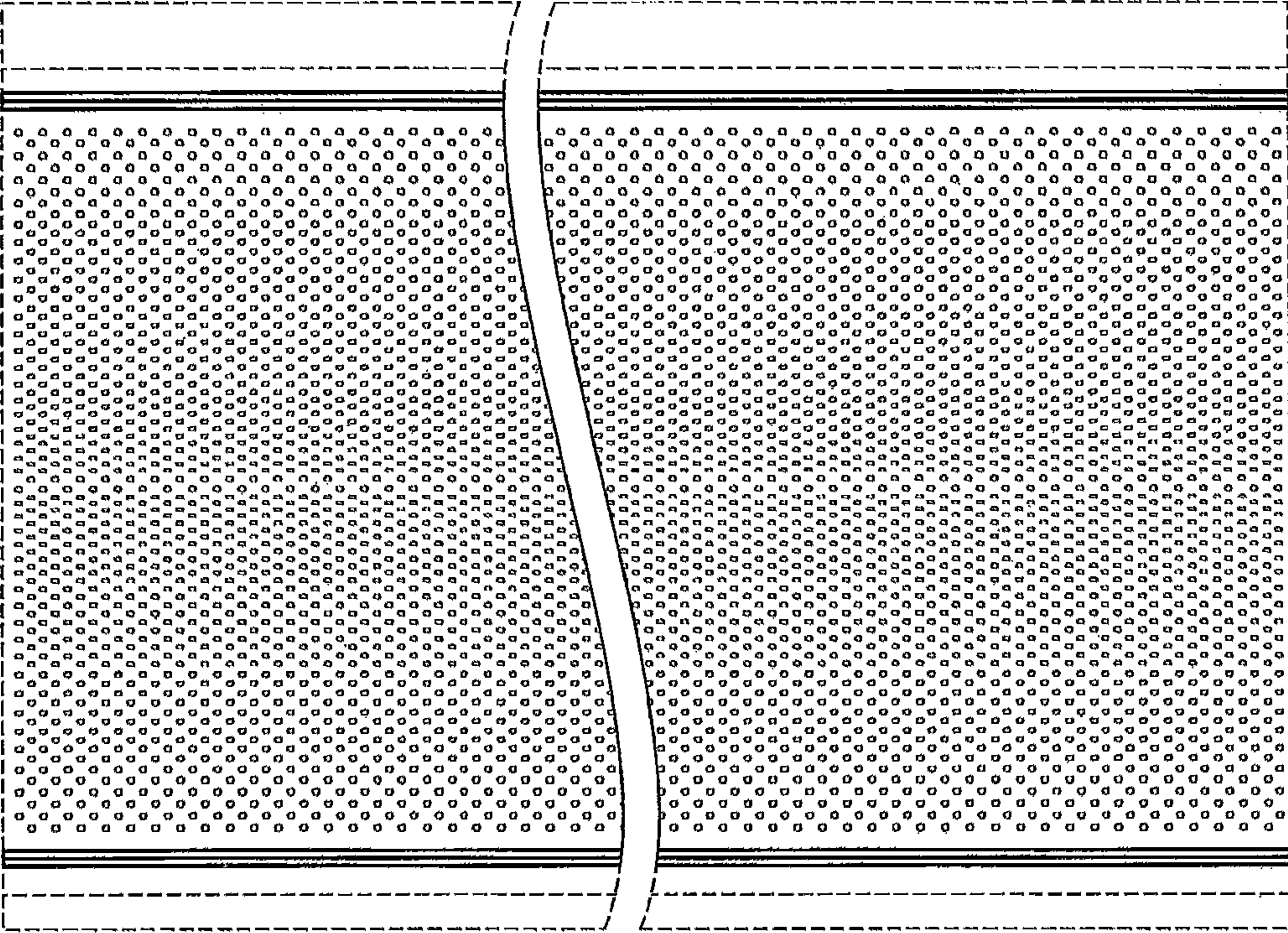

FIG. 3

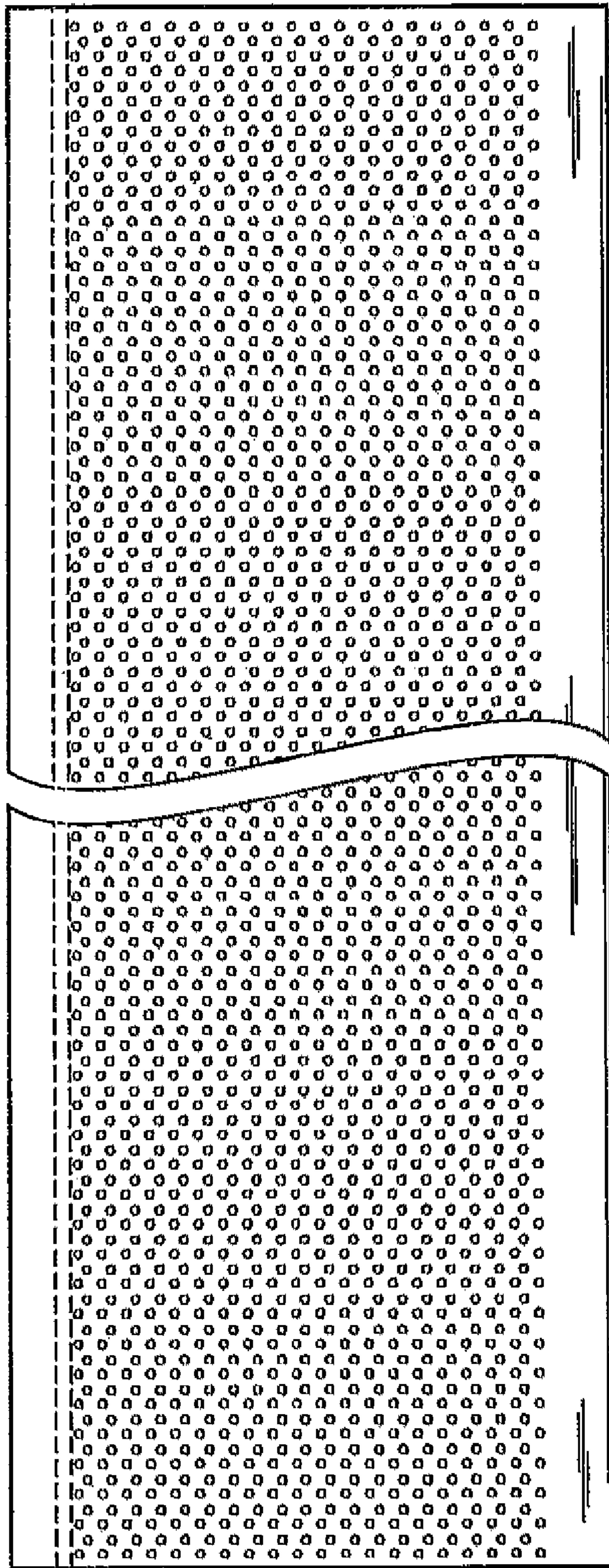

FIG. 4

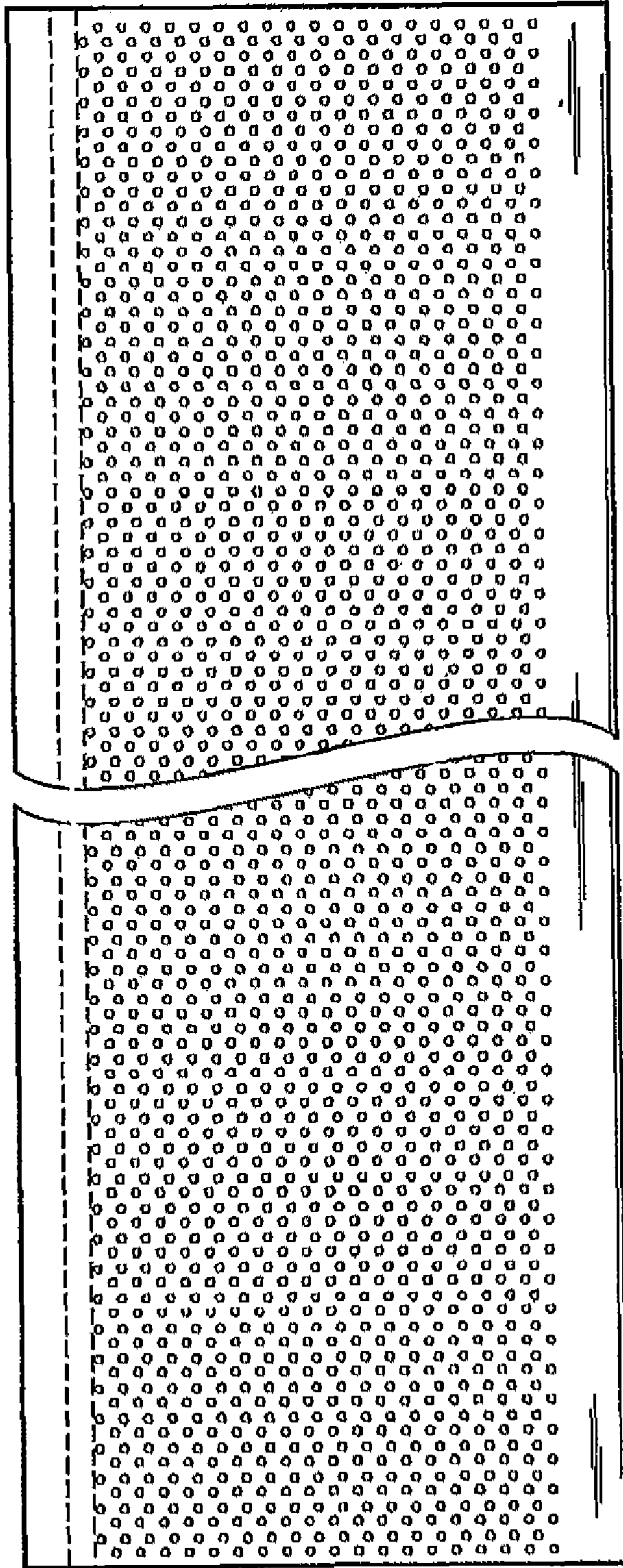

FIG. 5

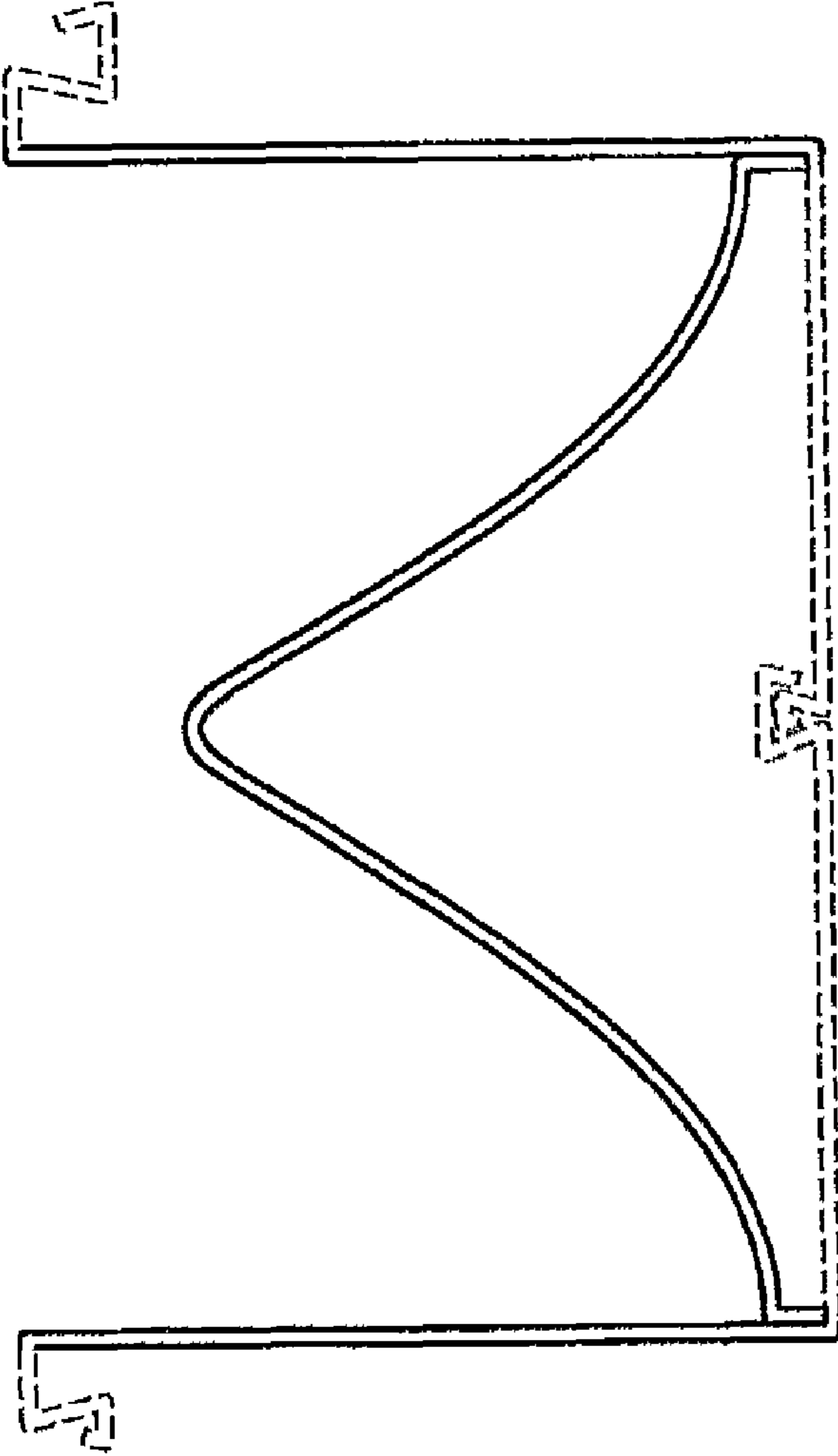

FIG. 6

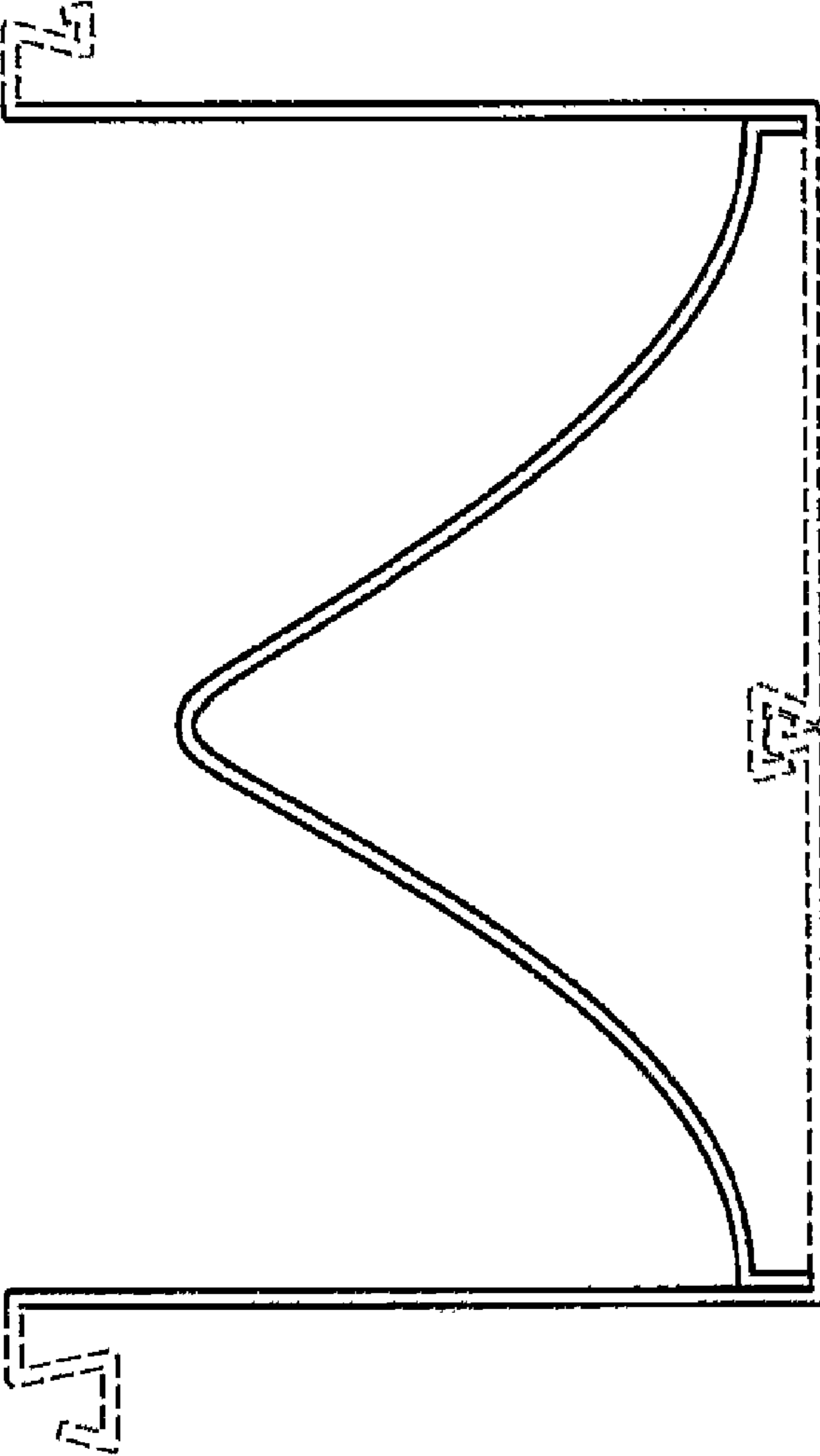

FIG. 7

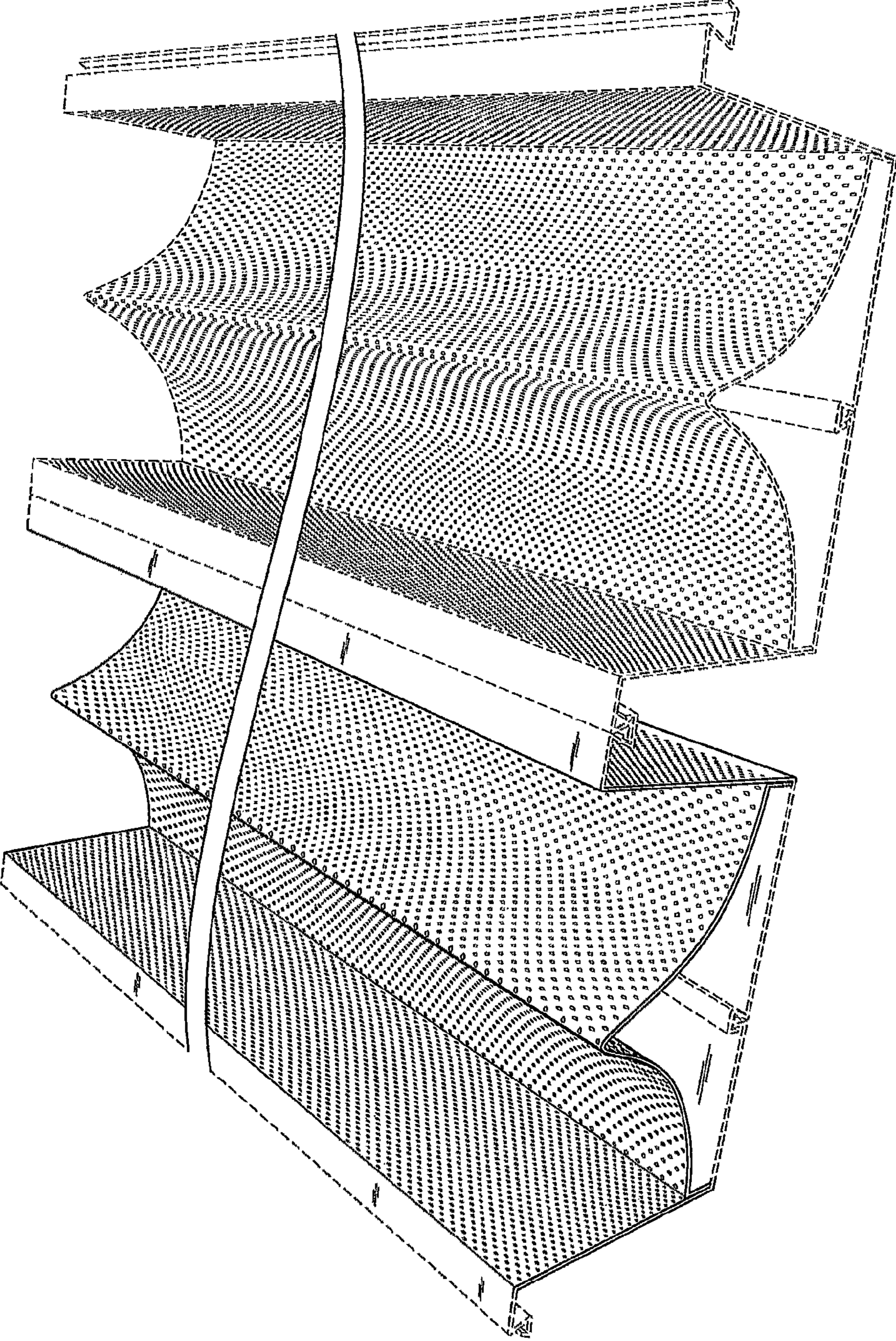

FIG. 8