



US00D661409S

(12) **United States Design Patent**  
**Riccobene**

(10) **Patent No.:** **US D661,409 S**  
(45) **Date of Patent:** **\*\* Jun. 5, 2012**

(54) **PATIO STONE**

(75) Inventor: **Thomas S. Riccobene**, Albuquerque,  
NM (US)

(73) Assignee: **Keystone Retaining Wall Systems, Inc.**,  
Minneapolis, MN (US)

(\*\*) Term: **14 Years**

(21) Appl. No.: **29/401,904**

(22) Filed: **Sep. 16, 2011**

(51) **LOC (9) Cl.** ..... **25-01**

(52) **U.S. Cl.** ..... **D25/113**

(58) **Field of Classification Search** ..... D25/102-118,  
D25/136, 138, 140, 151, 152, 153, 156-162,  
D25/164; D21/484-491, 499-504; 405/16,  
405/284, 286; 52/503-505, 574, 575, 596-612;  
404/27-42

See application file for complete search history.

(56) **References Cited**

**U.S. PATENT DOCUMENTS**

3,171,335 A 3/1965 Pincon  
(Continued)

**FOREIGN PATENT DOCUMENTS**

GB 1047163 12/1987  
(Continued)

**OTHER PUBLICATIONS**

Pavestone brochure, Dreamscapes, published 2003.

(Continued)

*Primary Examiner* — Anhdao Doan

(74) *Attorney, Agent, or Firm* — Greer, Burns & Brain, Ltd.

(57) **CLAIM**

The ornamental design for a patio stone, as shown and described.

**DESCRIPTION**

FIG. 1 is a perspective view illustrating the top, back and right side of a first variant of a patio stone showing my new design.

FIG. 2 is a top plan view thereof.

FIG. 3 is a front side elevational view thereof.

FIG. 4 is a back side elevational view thereof.

FIG. 5 is a left side elevational view thereof.

FIG. 6 is a right side elevational view thereof.

FIG. 7 is a bottom view thereof.

FIG. 8 is a perspective view illustrating the top, back and right side of a second variant of a patio stone showing my new design.

FIG. 9 is a top plan view of the second variant.

FIG. 10 is a front side elevational view of the second variant.

FIG. 11 is a back side elevational view of the second variant.

FIG. 12 is left side elevational view of the second variant.

FIG. 13 is a right side elevational view of the second variant.

FIG. 14 is a bottom view of the second variant.

FIG. 15 is a perspective view illustrating the top, back and right side of a third variant of a patio stone showing my new design.

FIG. 16 is a top plan view of the third variant.

FIG. 17 is a front side elevational view of the third variant.

FIG. 18 is a back side elevational view of the third variant.

FIG. 19 is a left side elevational view of the third variant.

FIG. 20 is a right side elevational view of the third variant.

FIG. 21 is a bottom view of the third variant.

FIG. 22 is a perspective view illustrating the top, back and right side of a fourth variant of a patio stone showing my new design.

FIG. 23 is a top plan view of the fourth variant.

FIG. 24 is a front side elevational view of the fourth variant.

FIG. 25 is a back side elevational view of the fourth variant.

FIG. 26 is a left side elevational view of the fourth variant.

FIG. 27 is a right side elevational view of the fourth variant; and,

FIG. 28 is a bottom view of the fourth variant.

The drawings show four variants of the design which do not differ substantially from each other. FIGS. 1 to 7 show the first variant, FIGS. 8-14 show the second variant, FIGS. 15-21 show the third variant, and FIGS. 22-28 show the fourth variant. The dashed lines in figures define bounds of the claimed design and form no part of the claimed design.

**1 Claim, 8 Drawing Sheets**

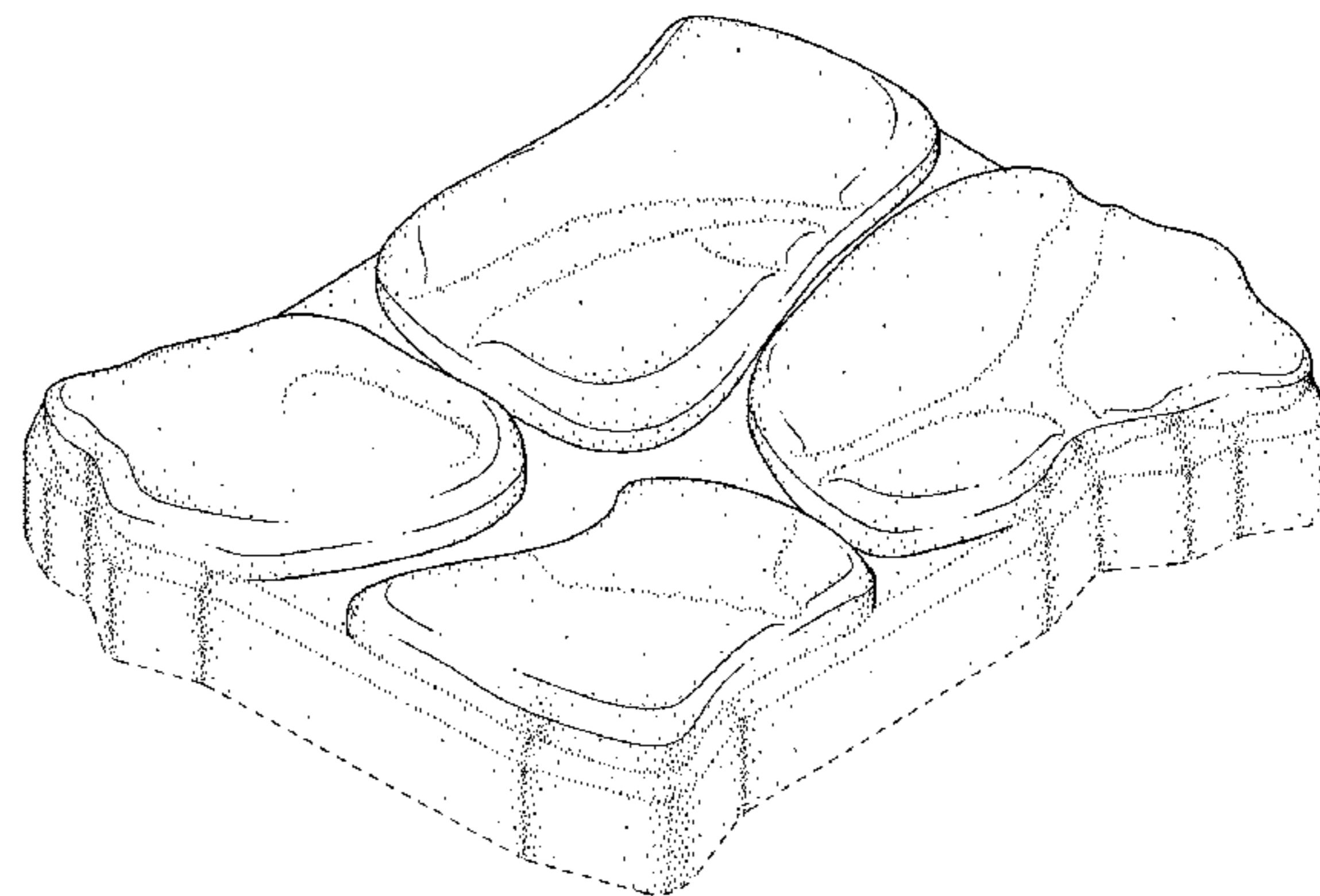
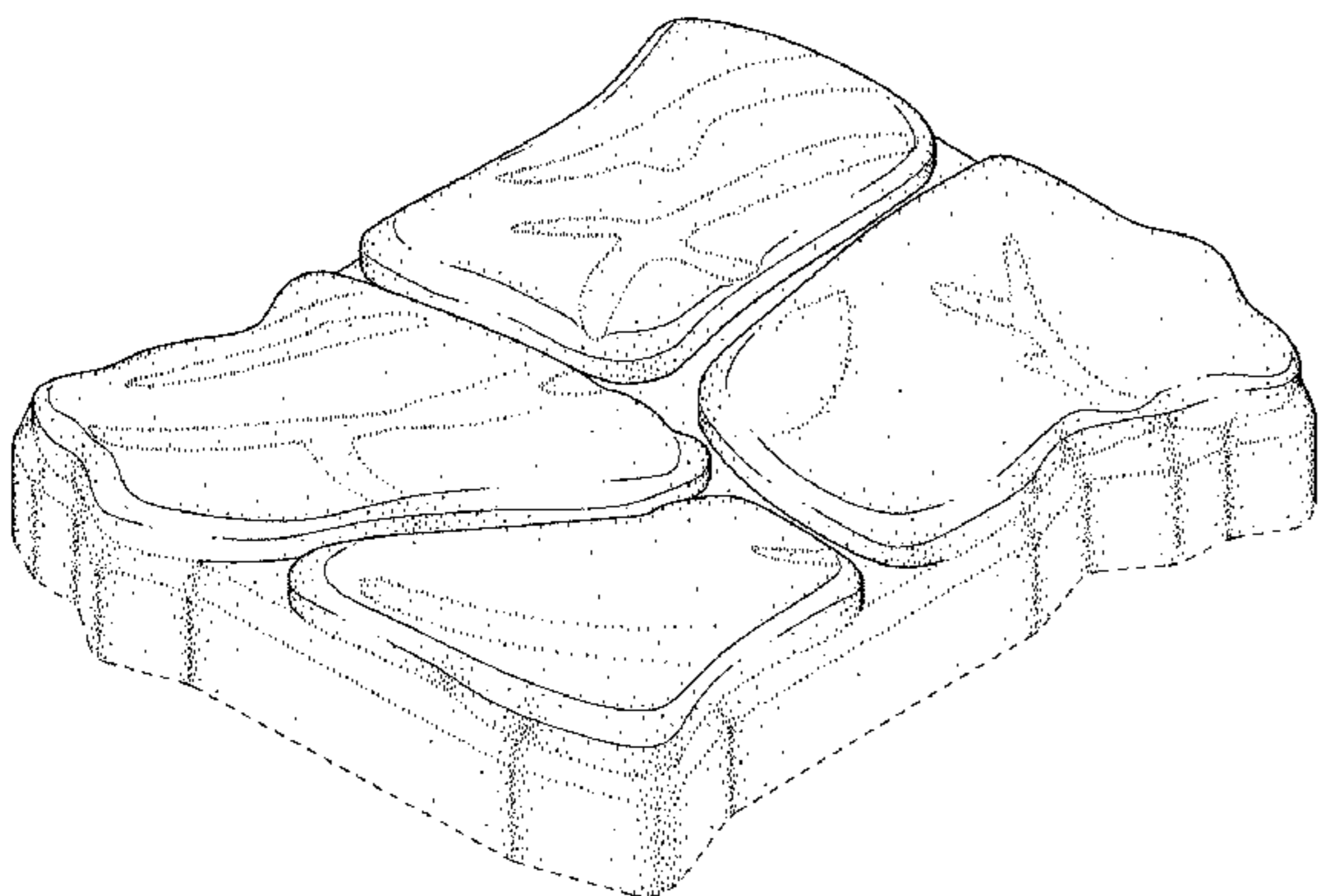

# US D661,409 S

Page 2

## U.S. PATENT DOCUMENTS

D231,926 S 6/1974 Appleton  
4,354,773 A 10/1982 Noack  
D287,884 S \* 1/1987 Scheiwiller ..... D25/113  
D404,147 S 1/1999 Woolford  
5,884,445 A 3/1999 Woolford  
D429,343 S 8/2000 Milot  
D439,677 S 3/2001 Mattox  
D461,011 S \* 7/2002 Stepanchick ..... D25/113  
6,536,988 B2 3/2003 Geiger  
D477,419 S 7/2003 Manthei  
D537,959 S 3/2007 Castonguay  
D540,954 S \* 4/2007 Bouchard ..... D25/113  
D543,642 S 5/2007 Castonguay  
D550,375 S 9/2007 Thomassen  
D553,260 S 10/2007 Castonguay  
7,393,155 B2 7/2008 Riccobene  
D574,514 S \* 8/2008 Bouchard ..... D25/113

D582,056 S \* 12/2008 Plies ..... D25/113  
D590,070 S 4/2009 Castonguay  
D590,071 S 4/2009 Castonguay  
D590,072 S 4/2009 Castonguay  
D601,268 S \* 9/2009 Hanna ..... D25/113  
D602,604 S \* 10/2009 Harris ..... D25/113  
D656,242 S \* 3/2012 MacDonald et al. .... D25/113  
D656,625 S \* 3/2012 MacDonald et al. .... D25/113

## FOREIGN PATENT DOCUMENTS

SE 44357 10/1988

## OTHER PUBLICATIONS

Website: [www.superstore.com](http://www.superstore.com)—Split Rock, Jun. 13, 2005.  
Website: [www.matcrete.net/RandomStore.htm](http://www.matcrete.net/RandomStore.htm), Dec. 16, 2002.  
Matt Store brochure, Gordon Walk, published 2003.

\* cited by examiner

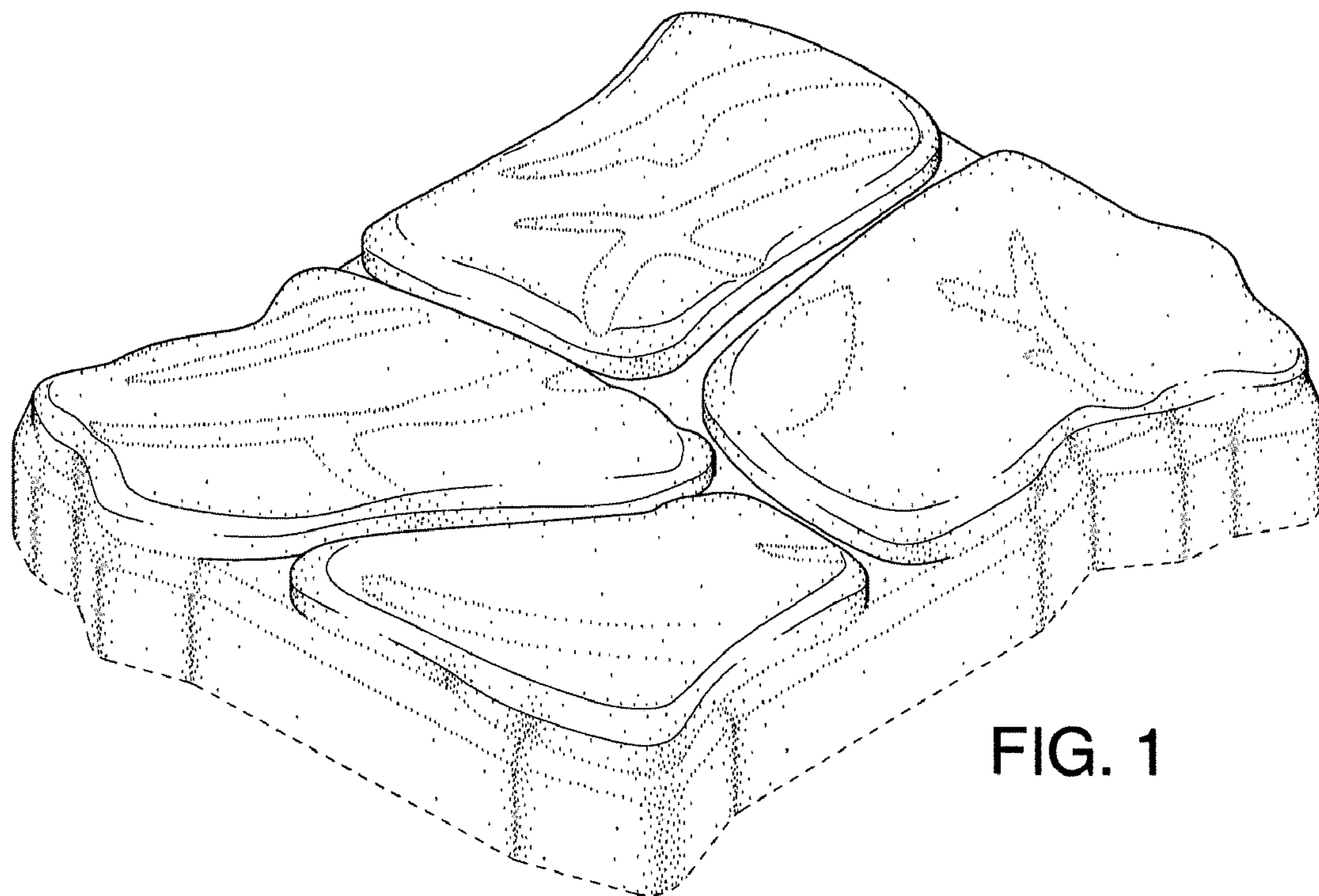

FIG. 1

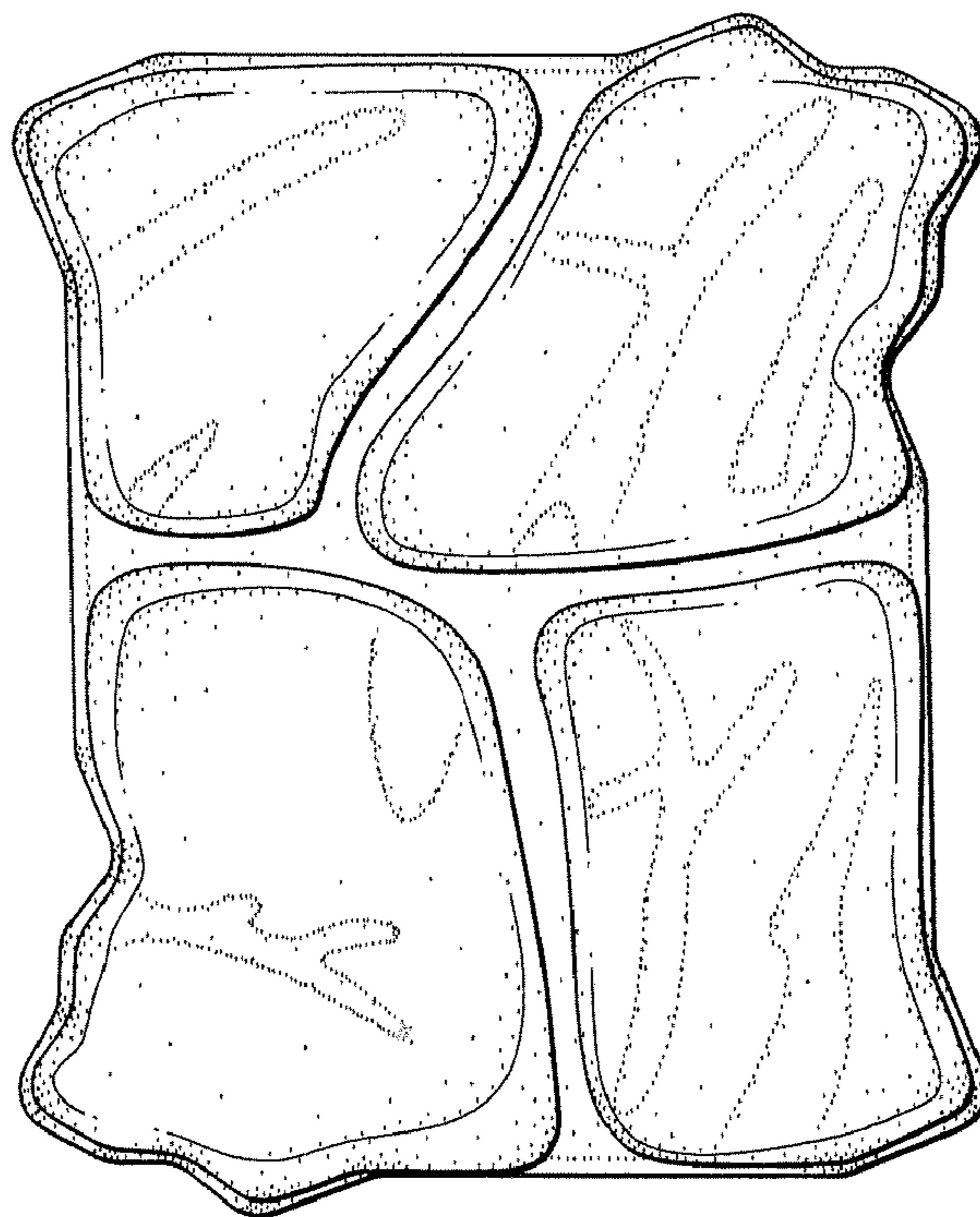

FIG. 2

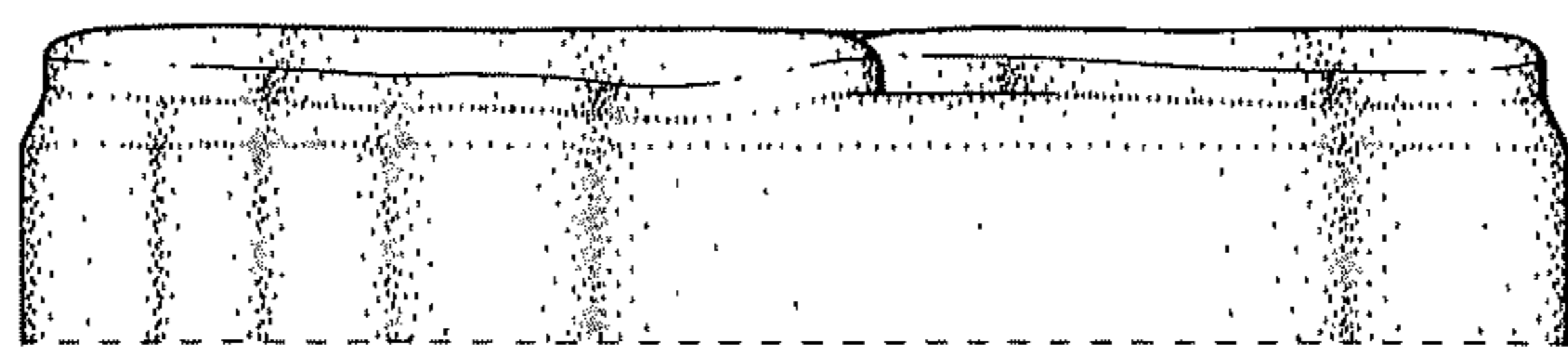

FIG. 3

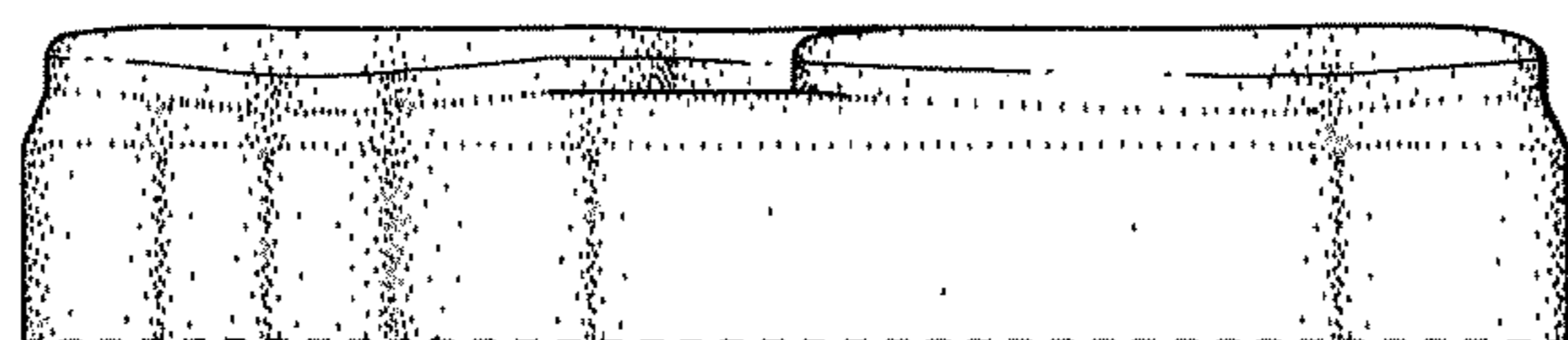

FIG. 4

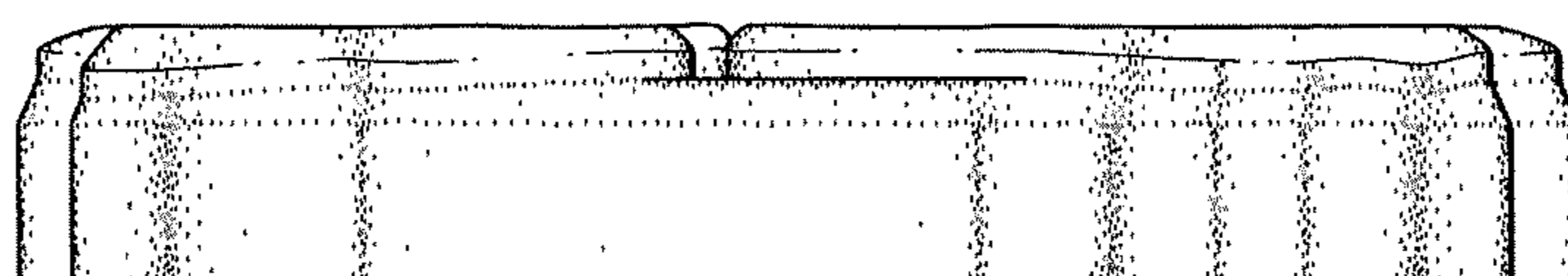

FIG. 5

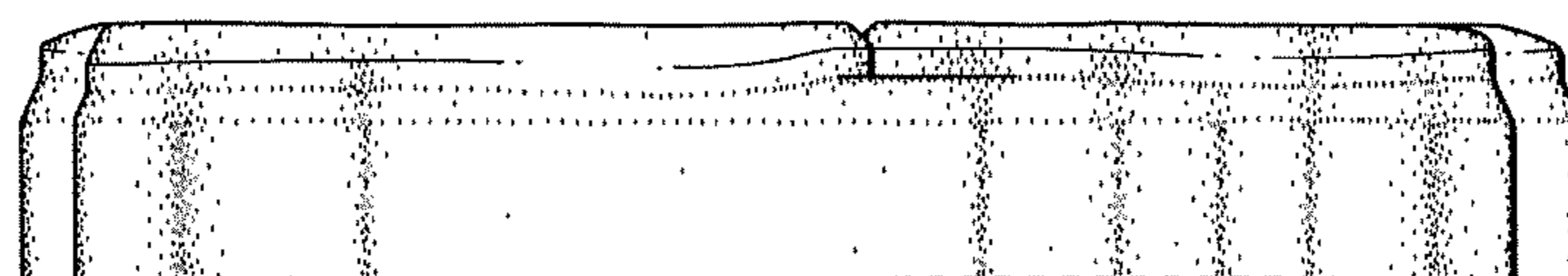

FIG. 6

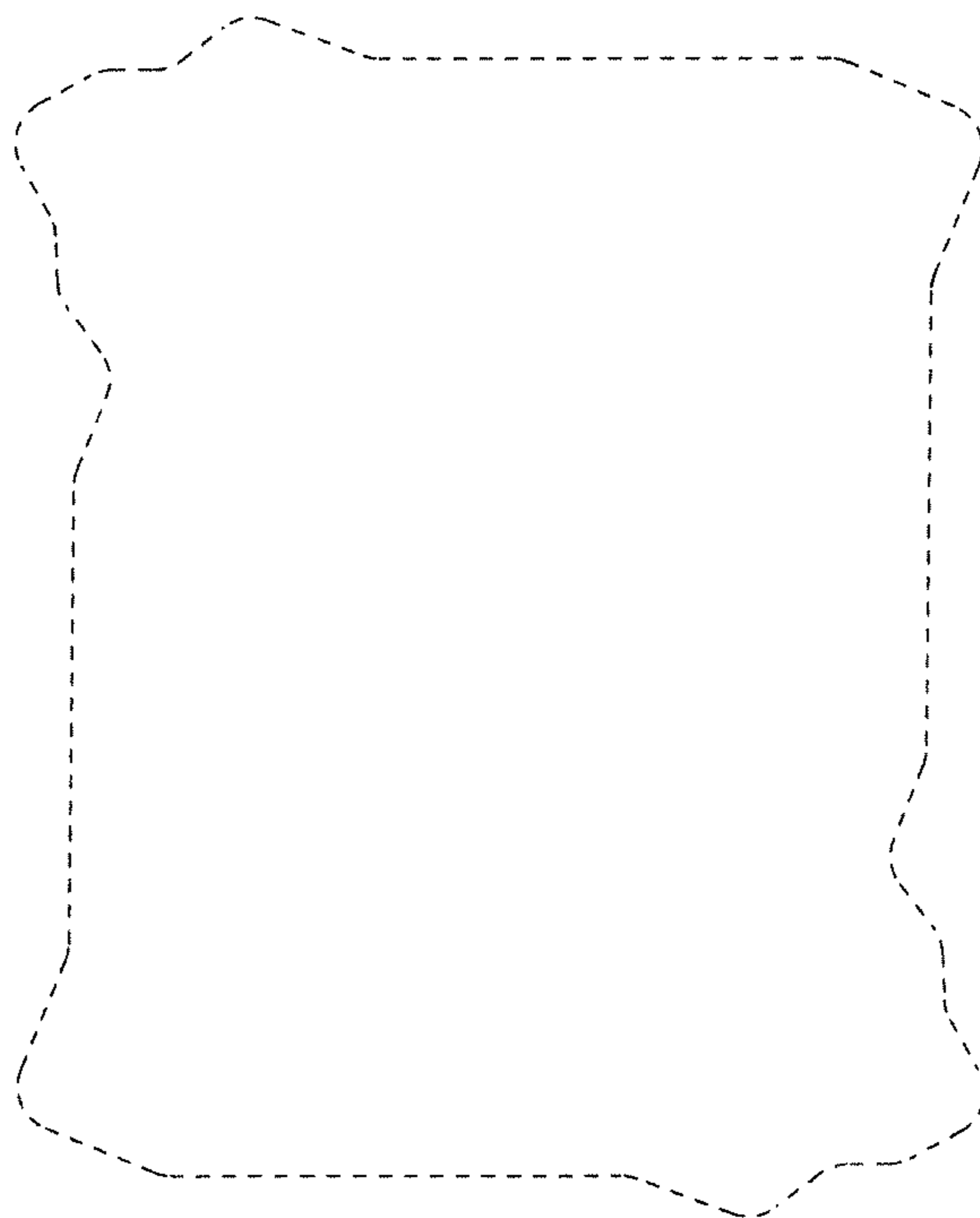

FIG. 7

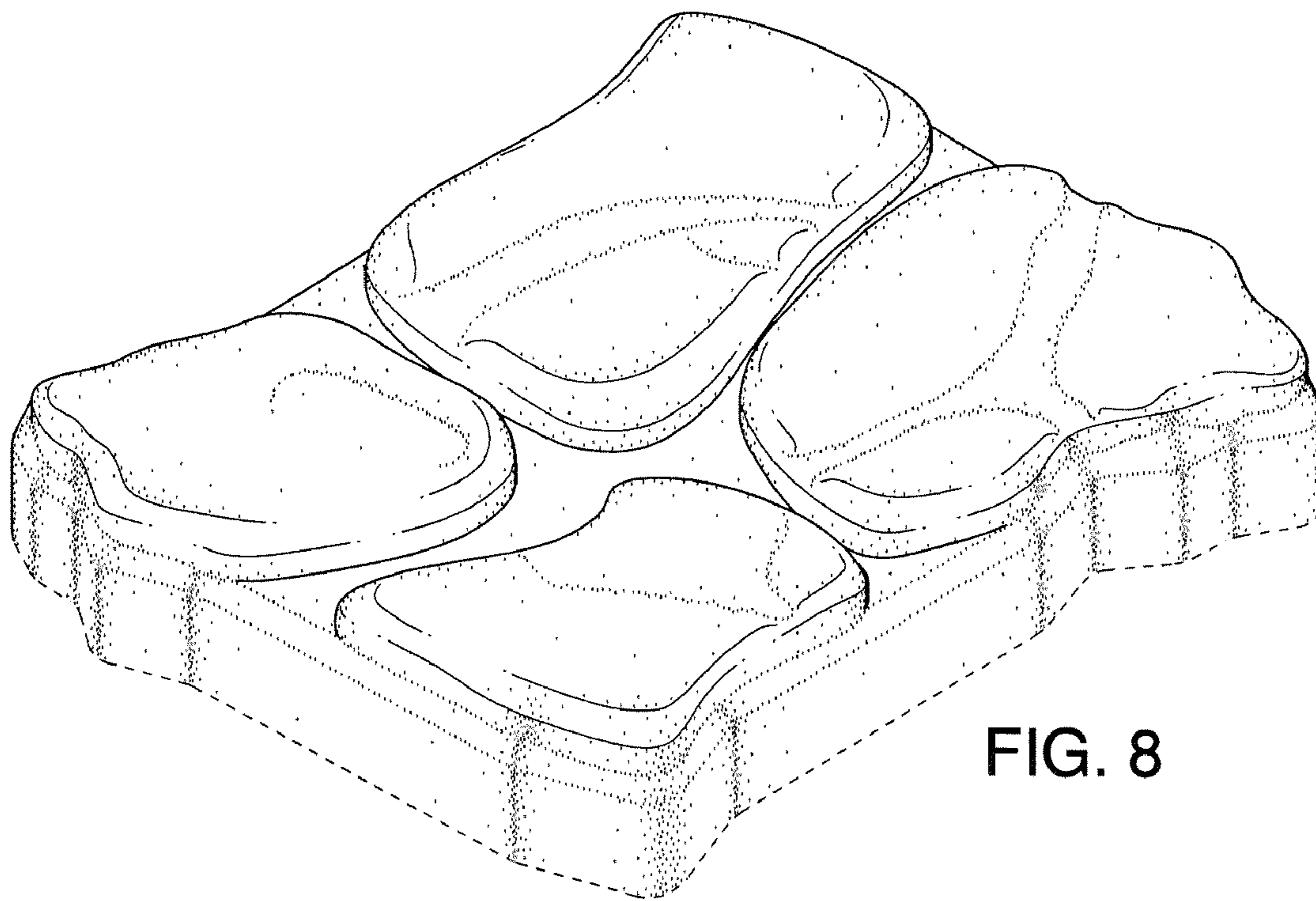

FIG. 8

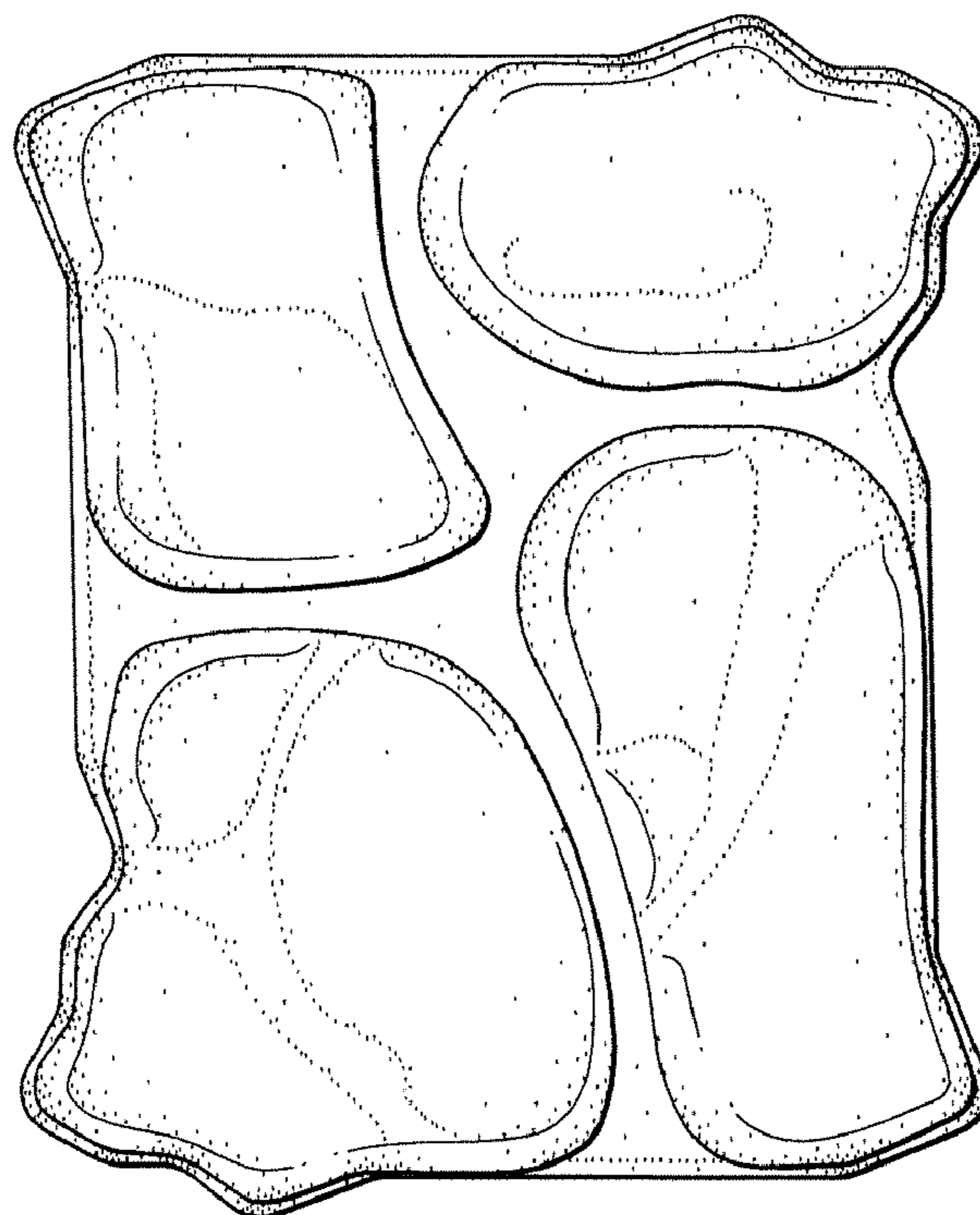

FIG. 9

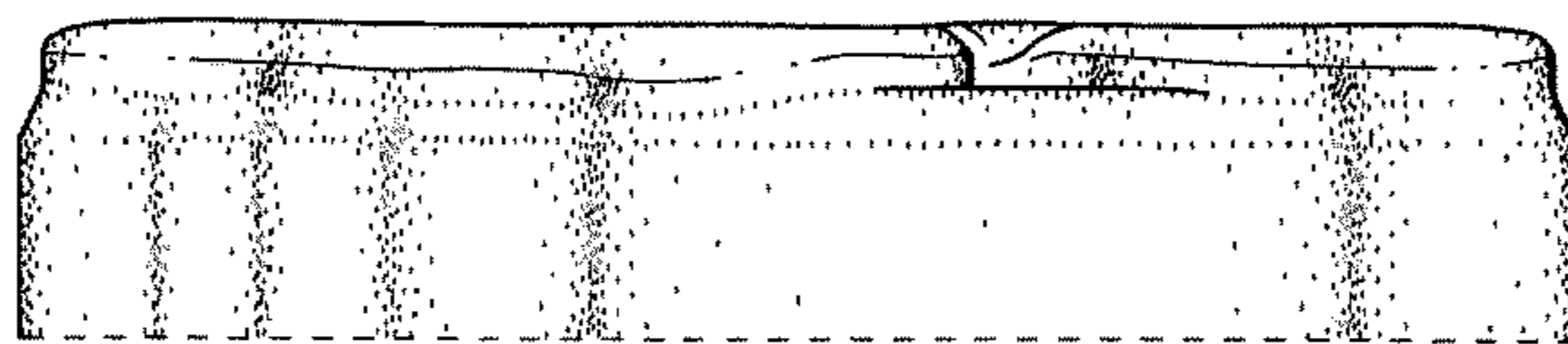

FIG. 10

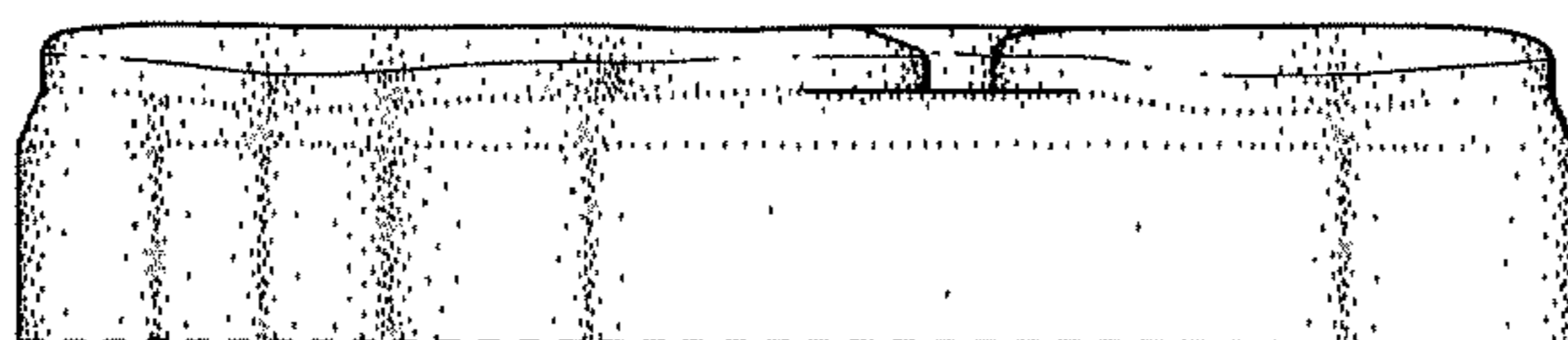

FIG. 11

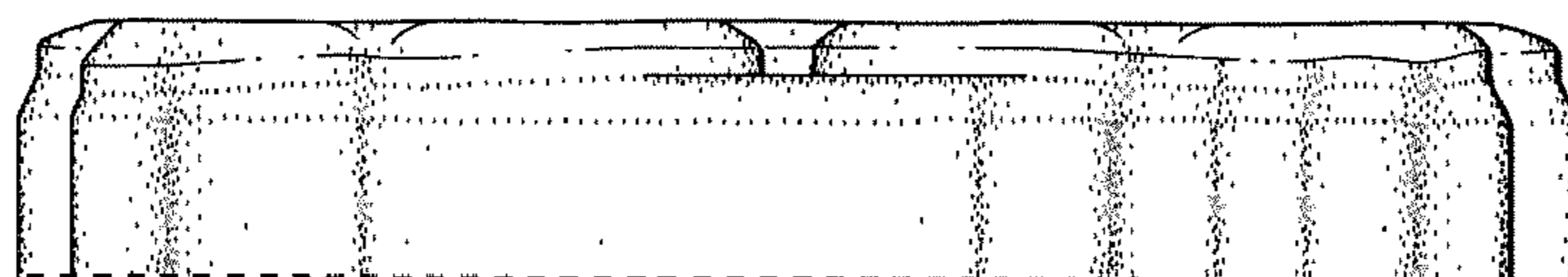

FIG. 12



FIG. 13

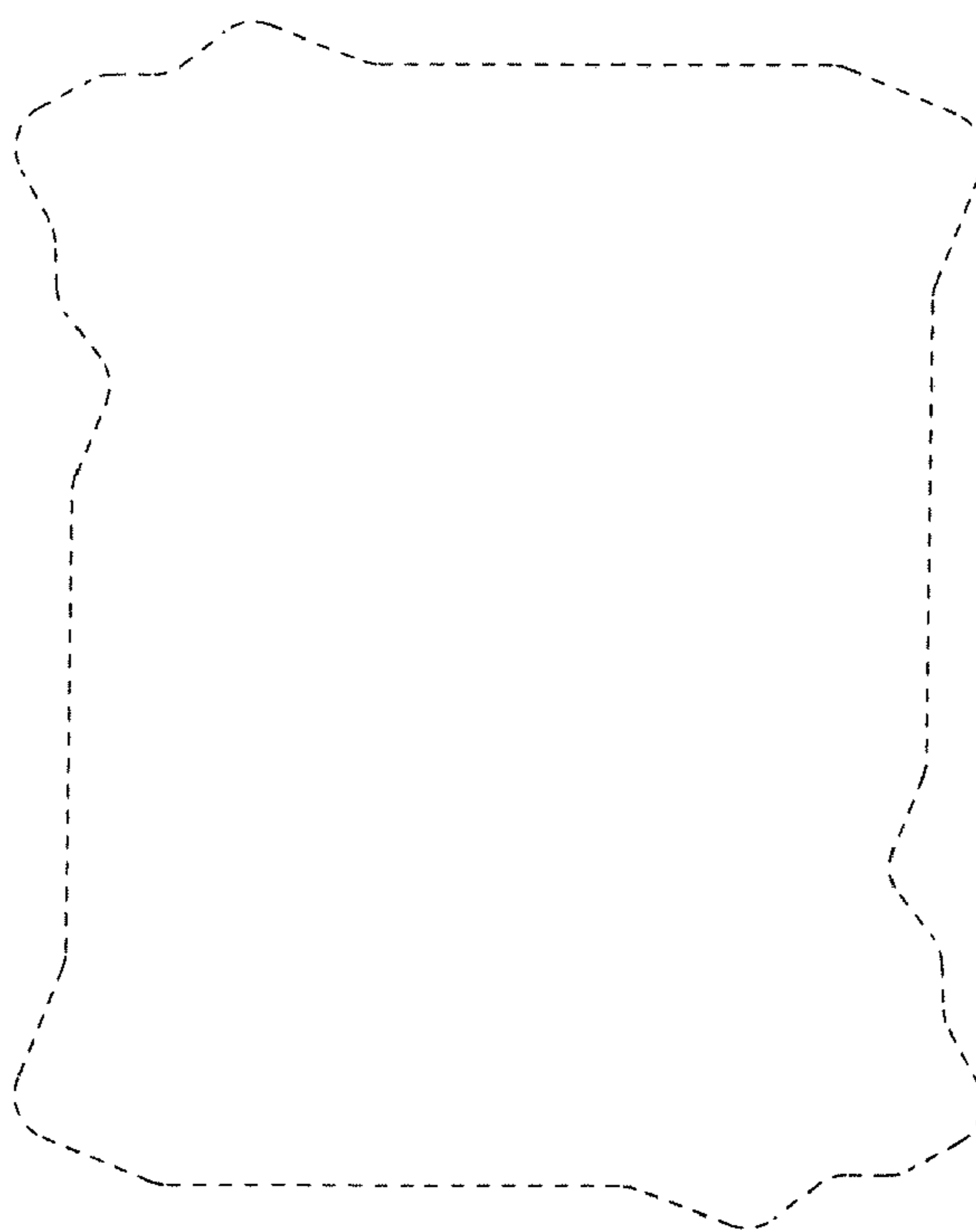

FIG. 14

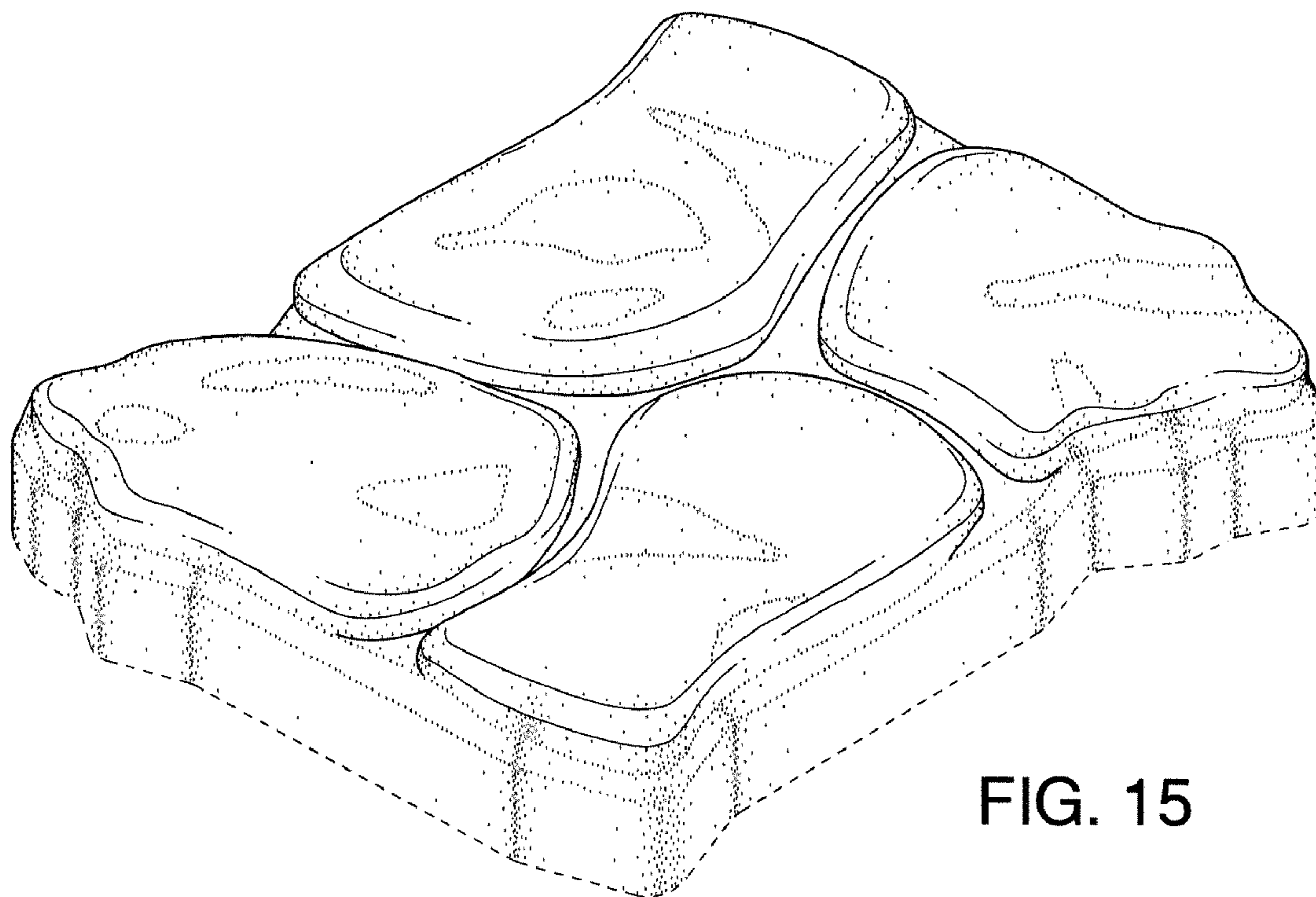

FIG. 15

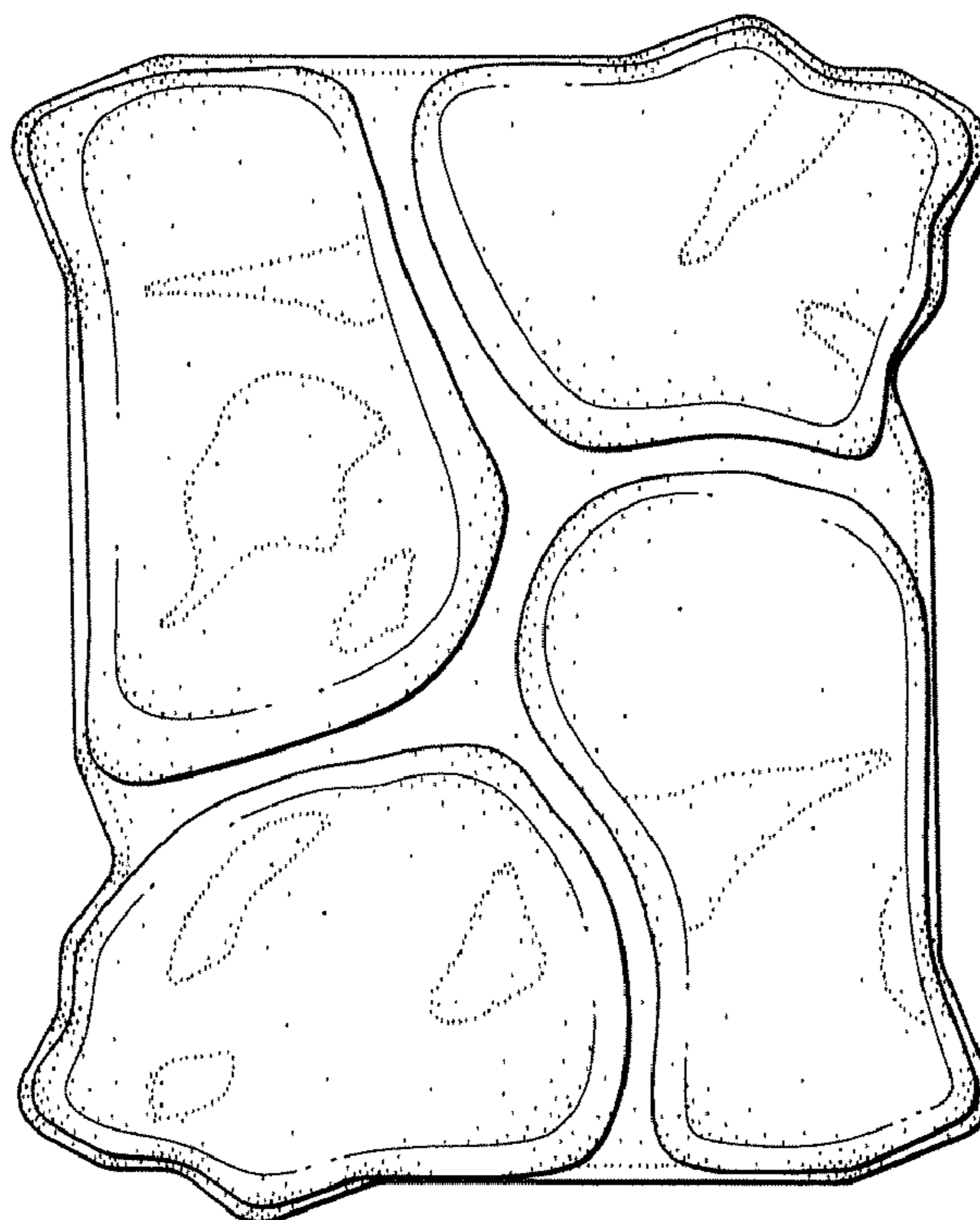

FIG. 16

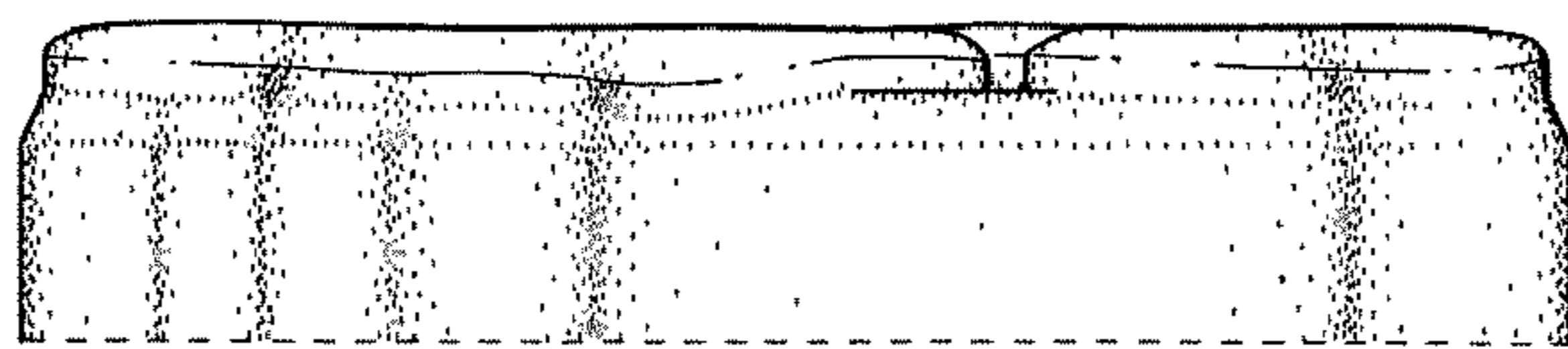

FIG. 17

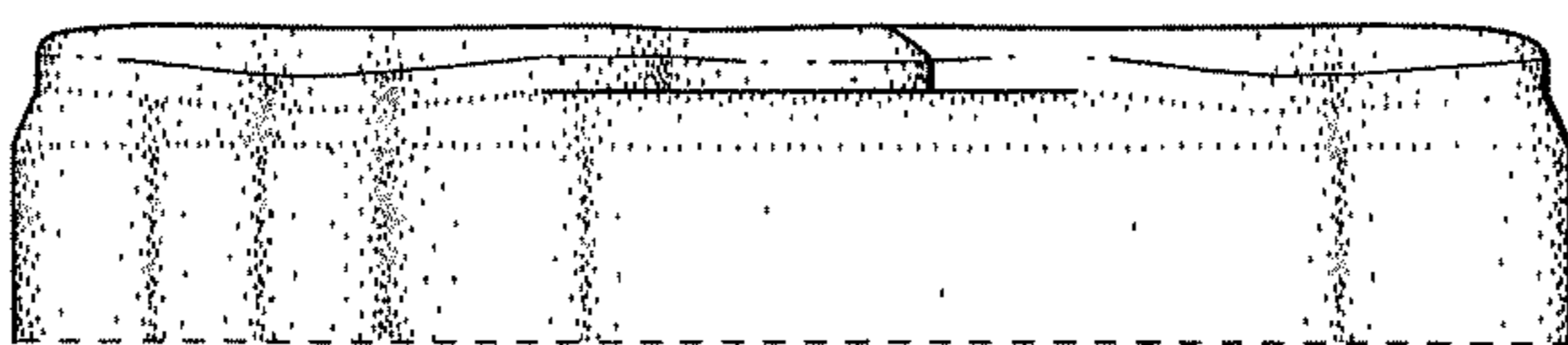

FIG. 18

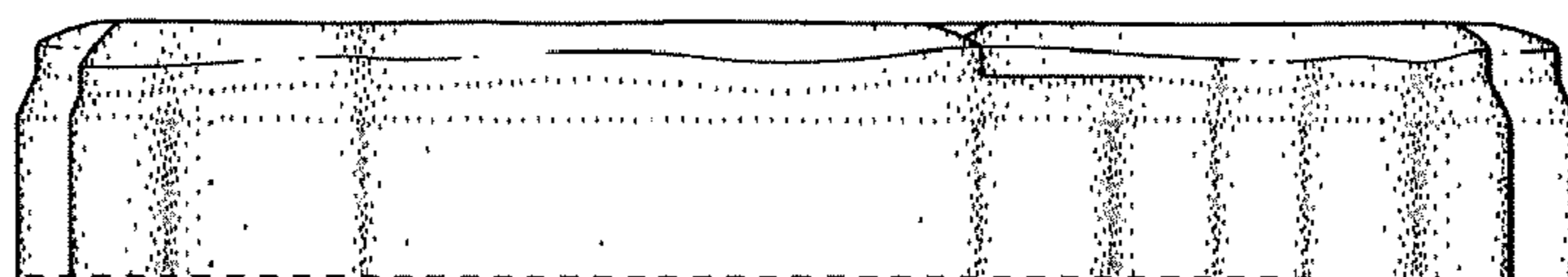

FIG. 19

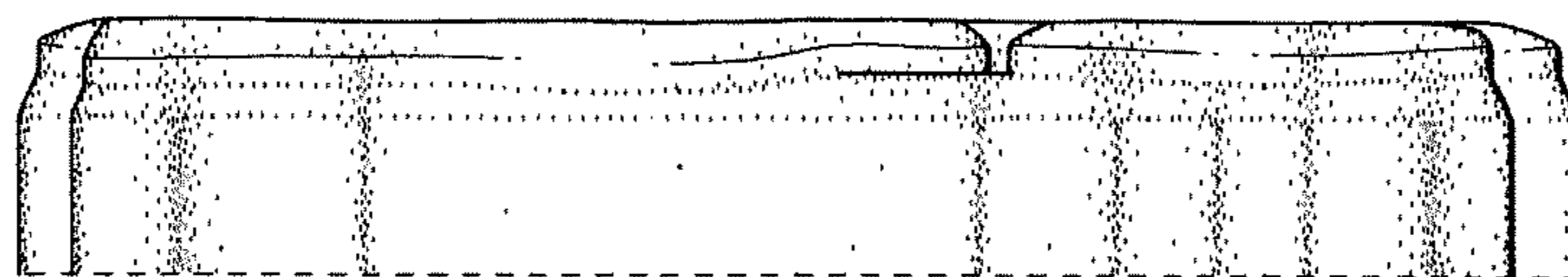

FIG. 20

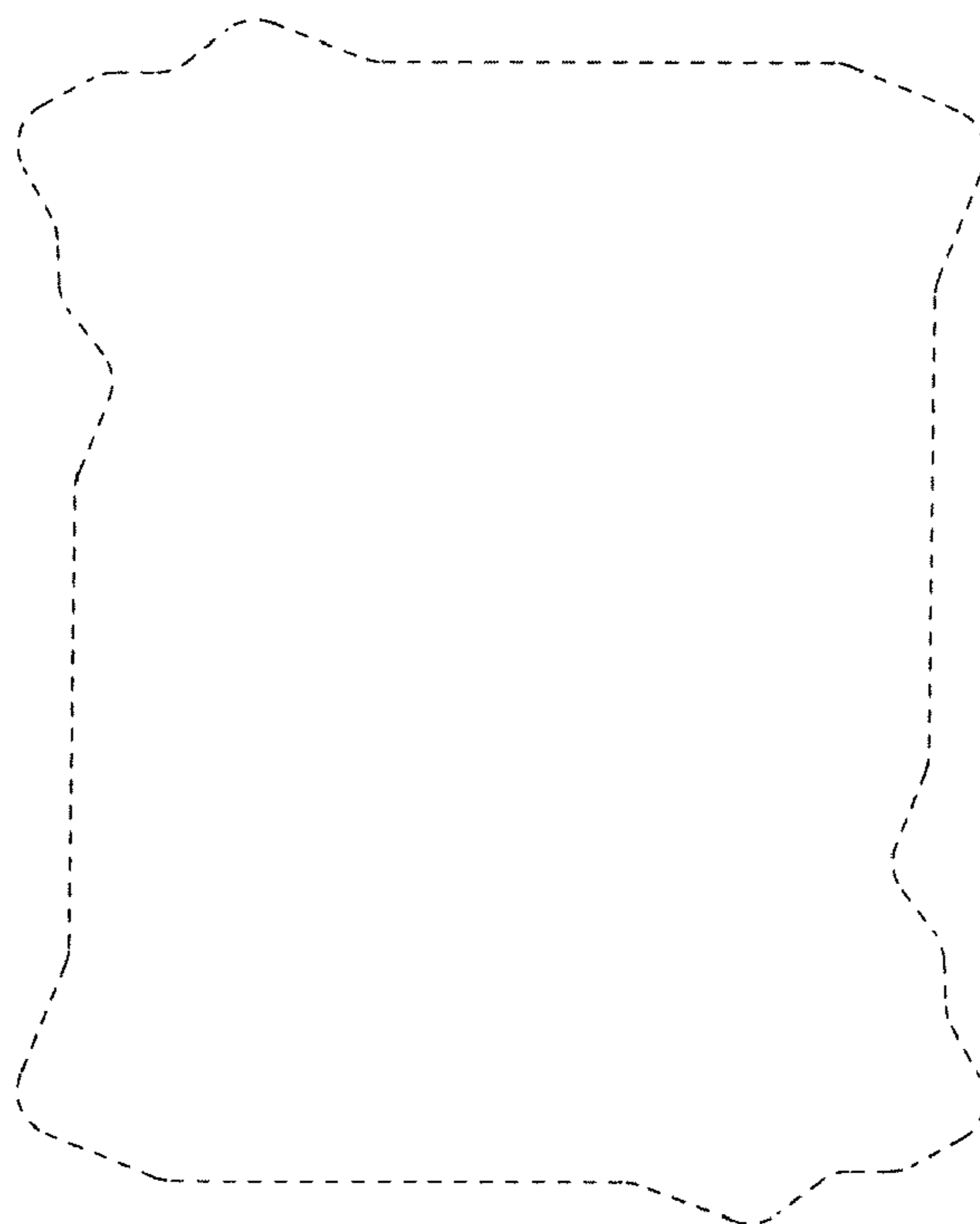

FIG. 21



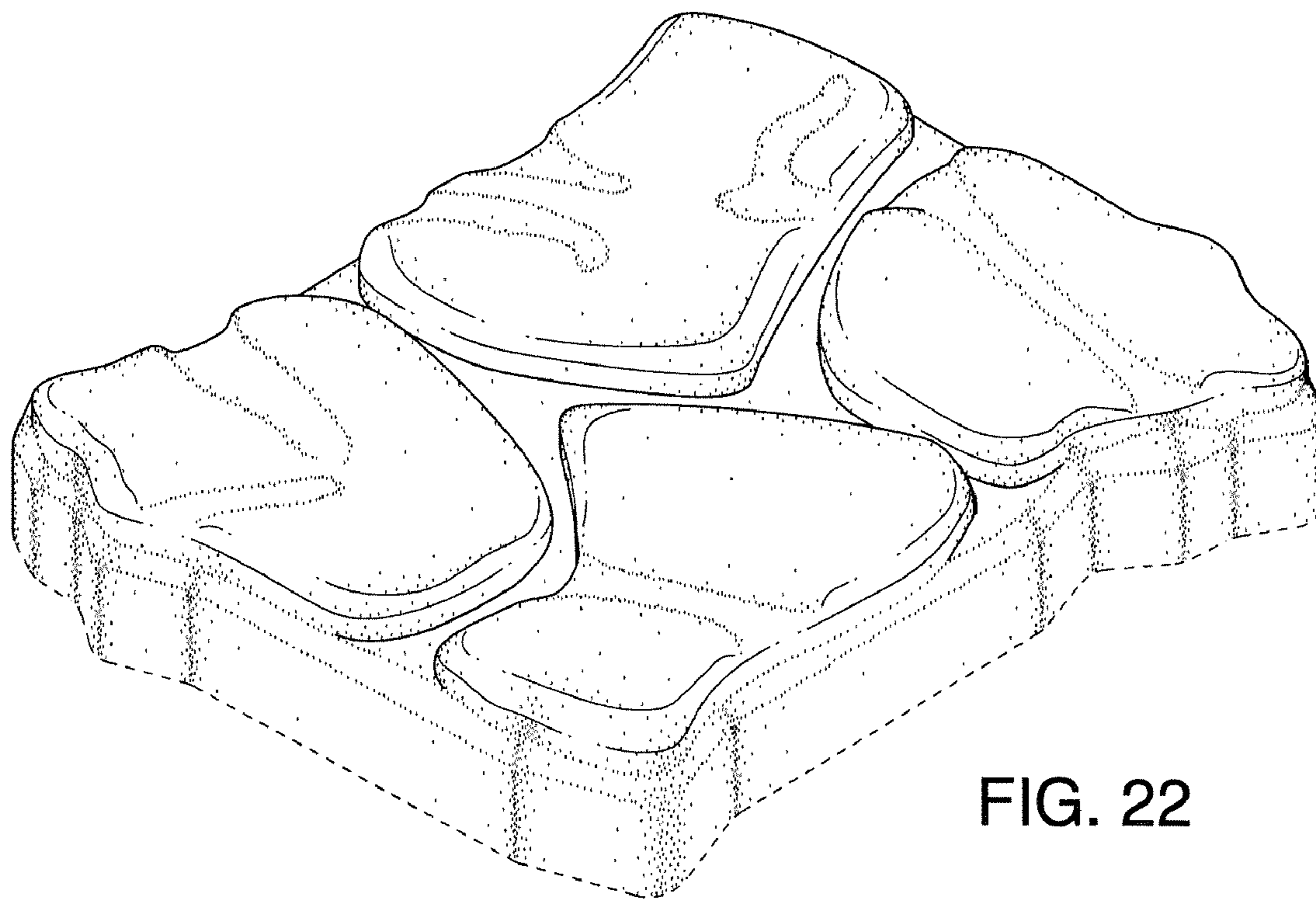

FIG. 22

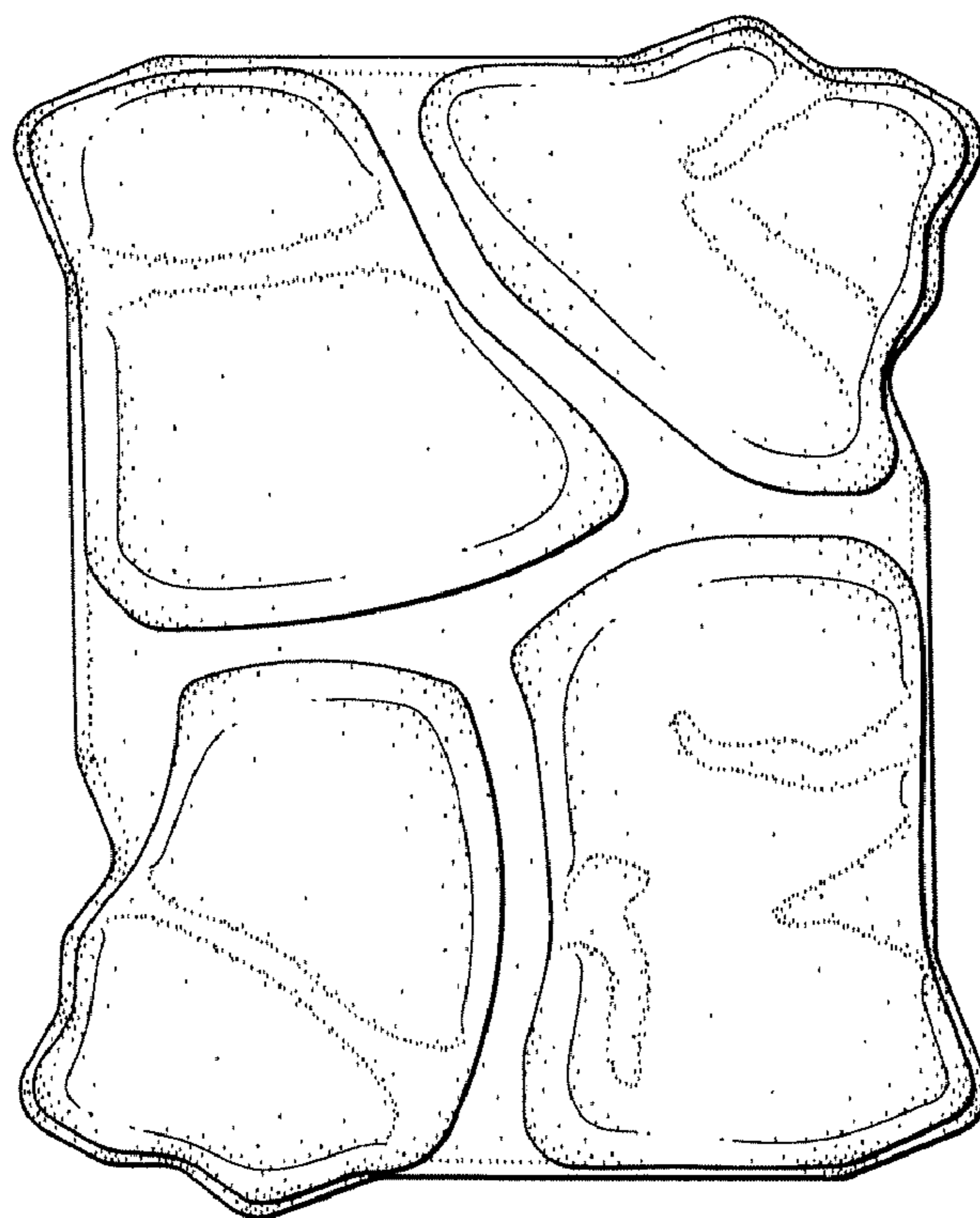

FIG. 23

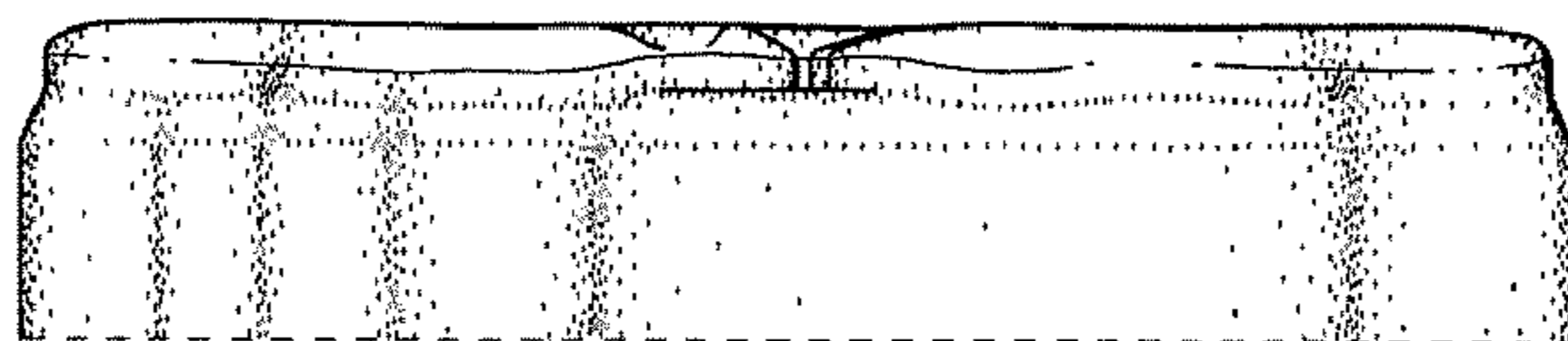

FIG. 24

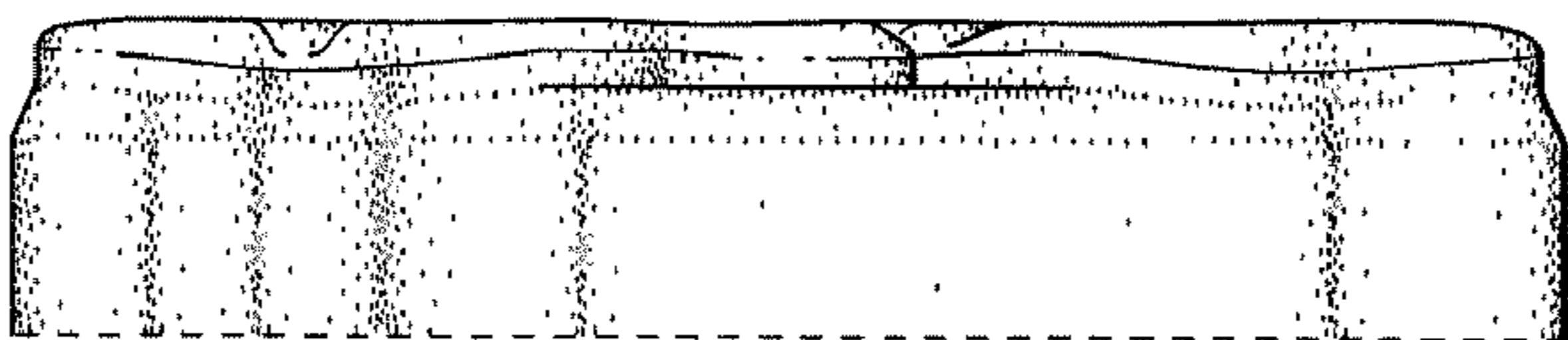

FIG. 25

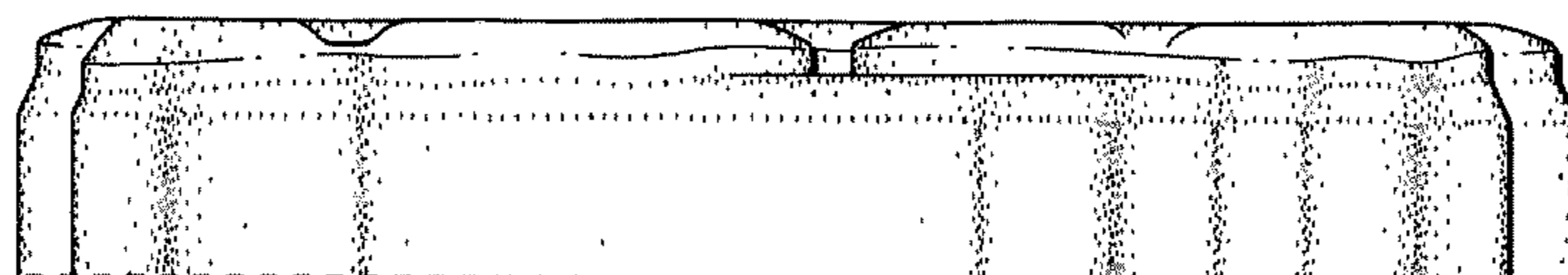

FIG. 26

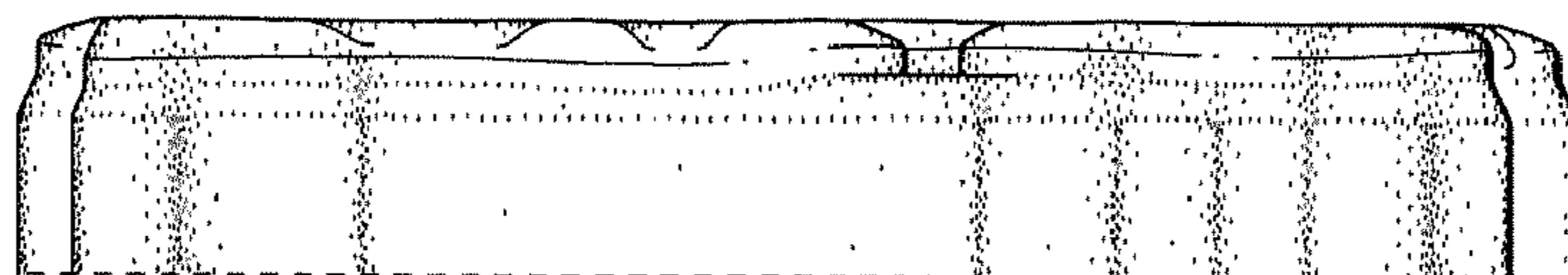

FIG. 27

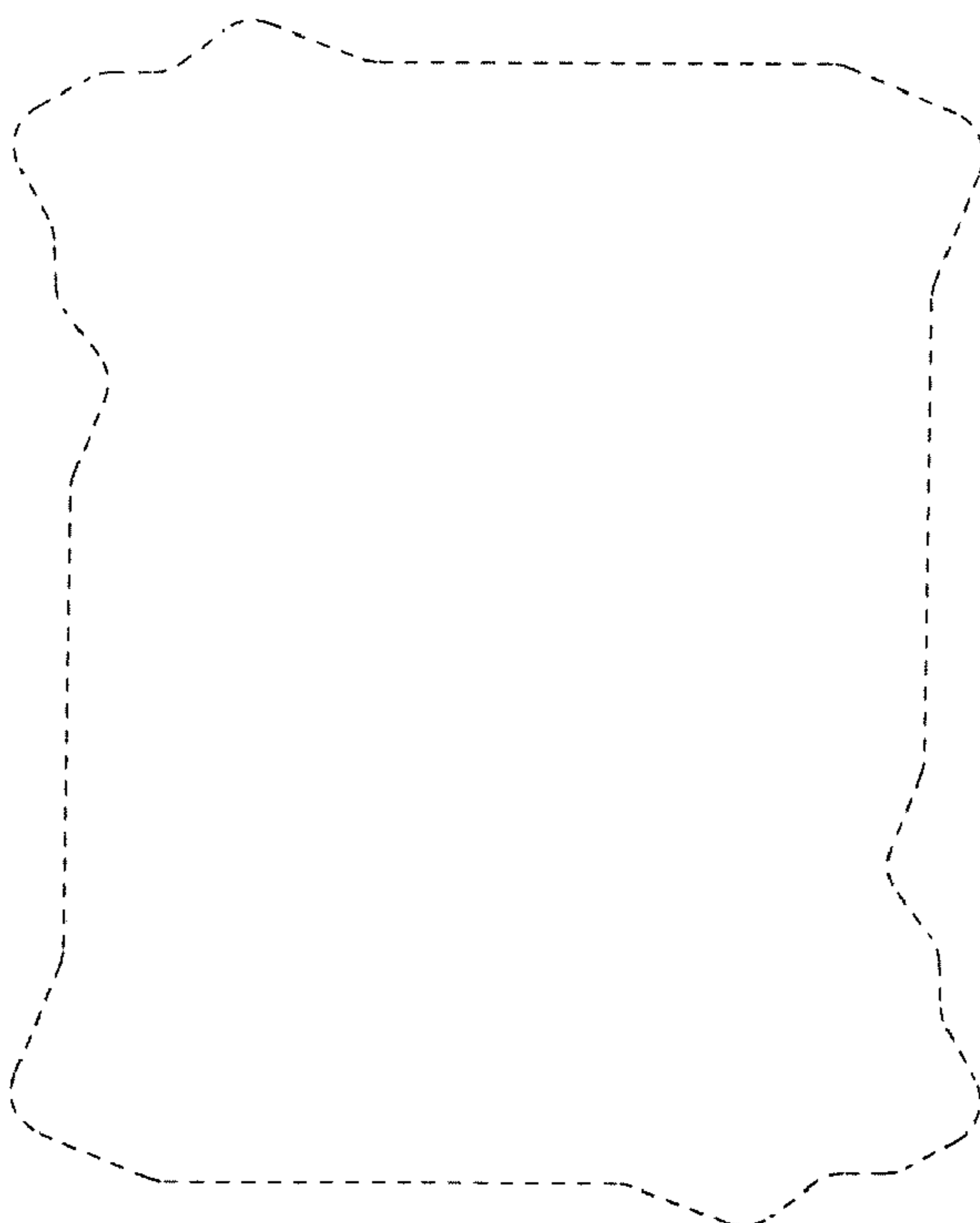

FIG. 28