



US00D661407S

(12) **United States Design Patent**  
**Riccobene**

(10) **Patent No.:** **US D661,407 S**  
(45) **Date of Patent:** **\*\* Jun. 5, 2012**

(54) **LANDSCAPE EDGER**  
(75) **Inventor:** **Thomas S. Riccobene**, Albuquerque,  
NM (US)  
(73) **Assignee:** **Keystone Retaining Wall Systems, Inc.**,  
Minneapolis, MN (US)

6,668,484 B2 12/2003 Riccobene  
D490,542 S 5/2004 MacDonald  
D491,675 S \* 6/2004 Ogawa et al. .... D25/113  
D512,784 S \* 12/2005 Quintana .... D25/115  
D557,428 S 12/2007 Doman  
D572,832 S \* 7/2008 Gratner et al. .... D25/113  
D602,172 S 10/2009 Gratner  
D647,632 S \* 10/2011 MacDonald .... D25/113

(\*\*) **Term:** **14 Years**  
(21) **Appl. No.:** **29/401,164**

**FOREIGN PATENT DOCUMENTS**

DE 4137814 5/1993  
NL 110004 11/1964

(22) **Filed:** **Sep. 8, 2011**  
(51) **LOC (9) Cl.** ..... **25-01**  
(52) **U.S. Cl.** ..... **D25/113**  
(58) **Field of Classification Search** ..... D25/102-118,  
D25/136, 138, 140, 151, 152, 153, 156-162,  
D25/164; D21/484-491, 499-504; 405/16,  
405/284, 286; 52/503-505, 574, 575, 596-612;  
404/27-42  
See application file for complete search history.

**OTHER PUBLICATIONS**

Pavestone, Beautiful Edgers brochure; Published 2002.  
Unpublished U.S. Appl. No. 29/377,311, filed Oct. 20, 2010 by  
Riccobene.

\* cited by examiner

*Primary Examiner* — Anhdao Doan  
(74) *Attorney, Agent, or Firm* — Greer, Burns & Crain, Ltd.

(56) **References Cited**

(57) **CLAIM**  
The ornamental design for a landscape edger, as shown and  
described.

**U.S. PATENT DOCUMENTS**

3,373,668 A 3/1968 Moore  
4,326,817 A 4/1982 Boiardi  
4,884,920 A 12/1989 Perazzi  
5,003,746 A \* 4/1991 Wilston ..... 52/608  
5,080,523 A 1/1992 Steiner  
5,108,219 A 4/1992 Hair  
5,154,032 A 10/1992 Ritter  
D370,394 S 6/1996 Lilley  
5,548,938 A 8/1996 Scheiwiller  
D388,290 S 12/1997 Riccobene  
D435,305 S \* 12/2000 Pullen et al. .... D25/164  
D448,857 S \* 10/2001 Staten et al. .... D25/113  
RE37,694 E 5/2002 Riccobene  
D462,786 S 9/2002 Ogawa  
D479,341 S 9/2003 Scullion et al.  
D480,818 S \* 10/2003 Ogawa et al. .... D25/113

**DESCRIPTION**

FIG. 1 is a perspective view of a landscape edger showing my  
new design.  
FIG. 2 is a side elevational thereof. The other side is a mirror  
image.  
FIG. 3 is a top plan view thereof.  
FIG. 4 is a bottom view thereof.  
FIG. 5 is an end view thereof; and,  
FIG. 6 is the other end view thereof.  
The dashed lines in FIGS. 1-2 and 4-6 define bounds of the  
claimed design and form no part of the claimed design.

**1 Claim, 4 Drawing Sheets**

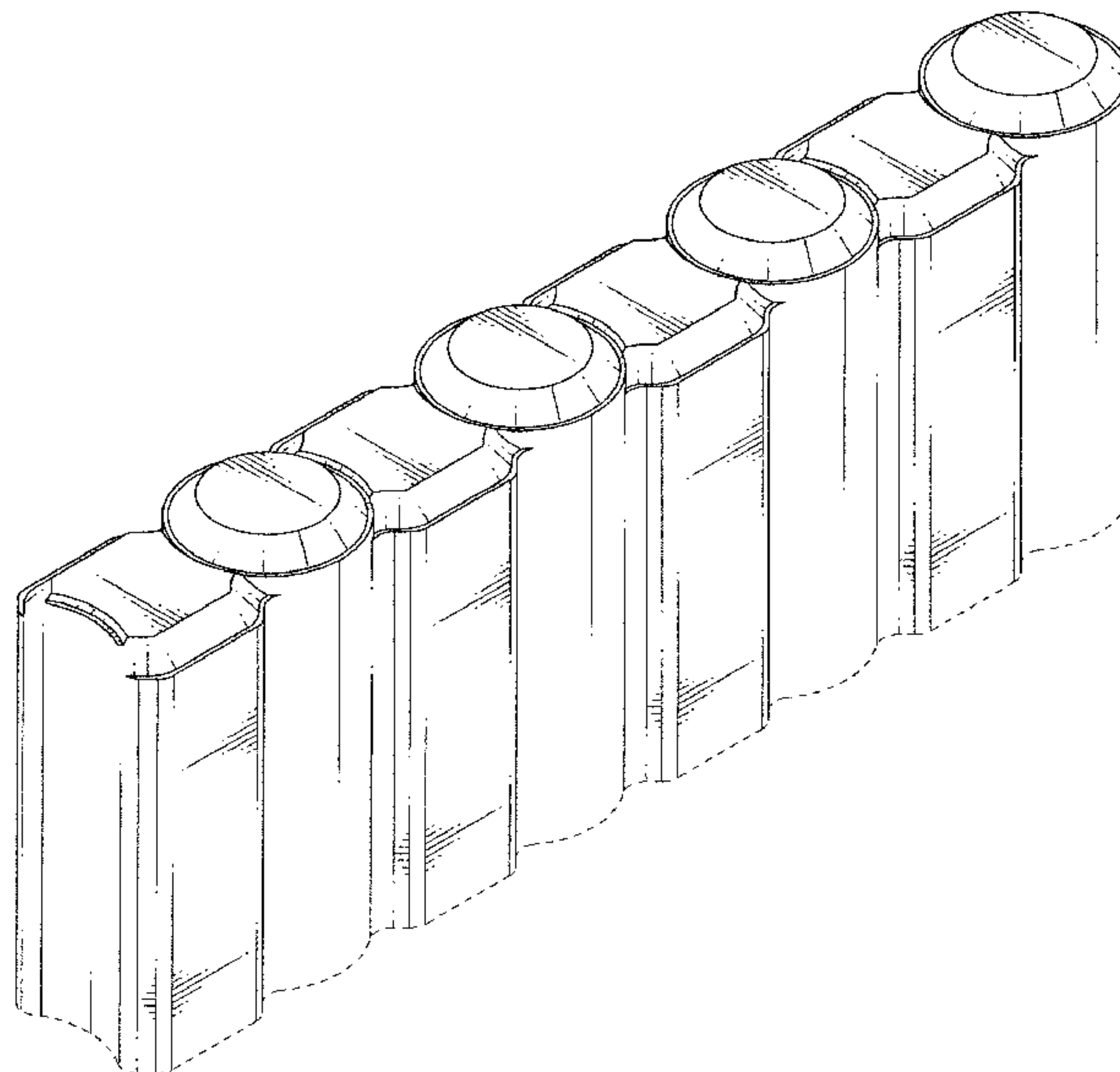

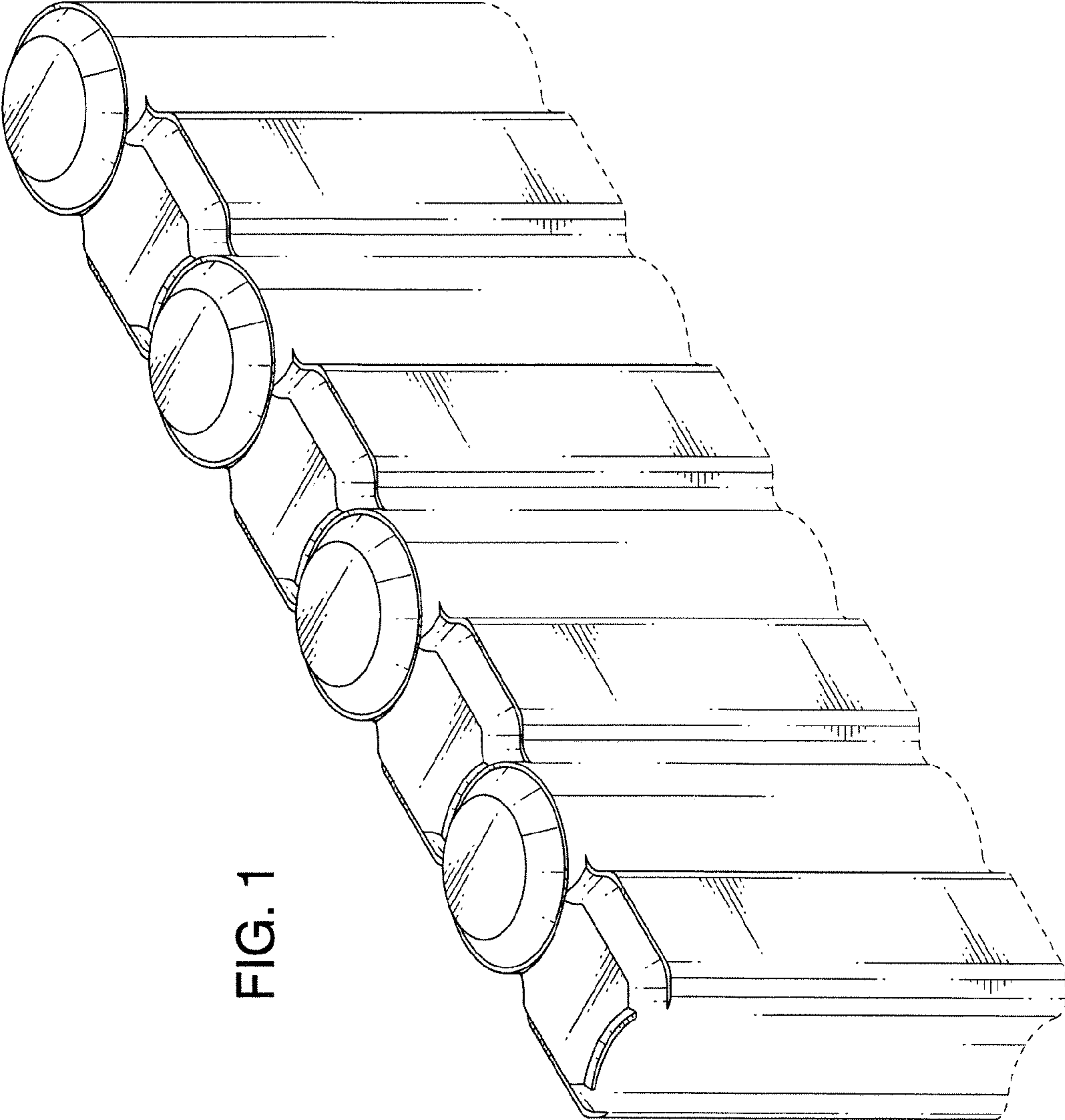

FIG. 1

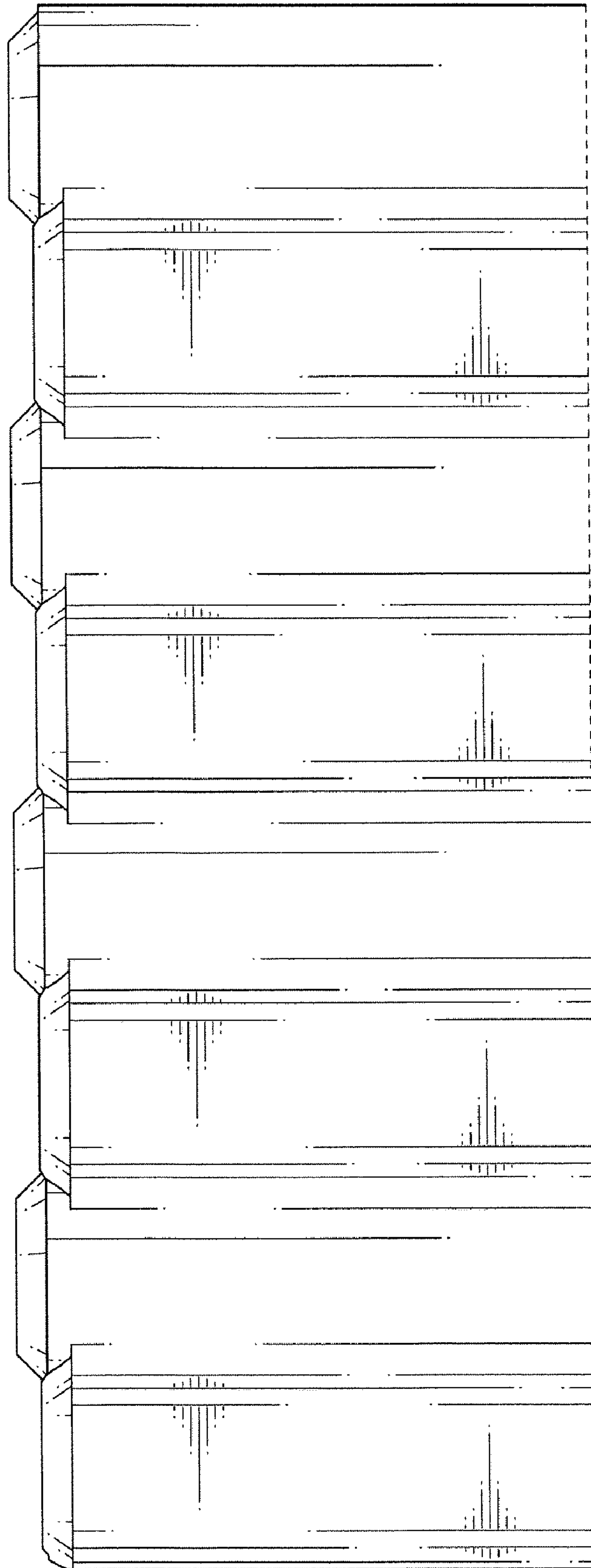

FIG. 2

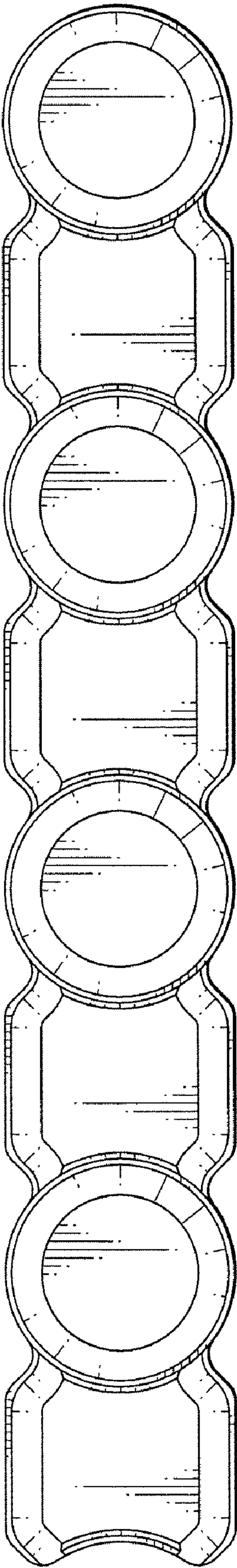

FIG. 3

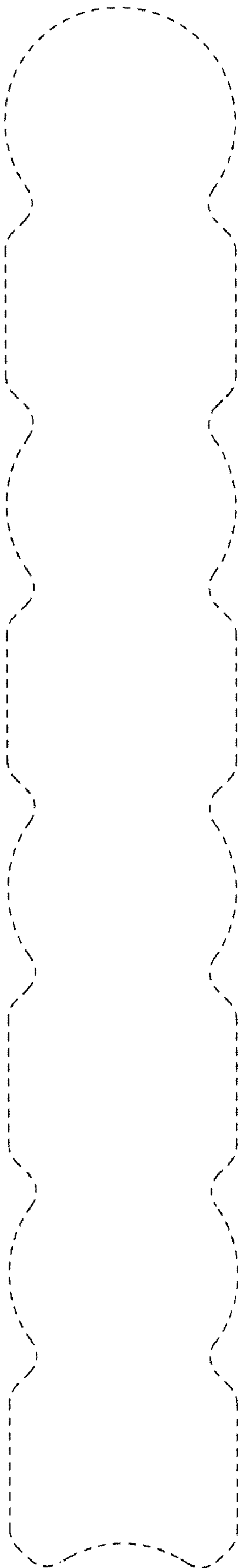

FIG. 4

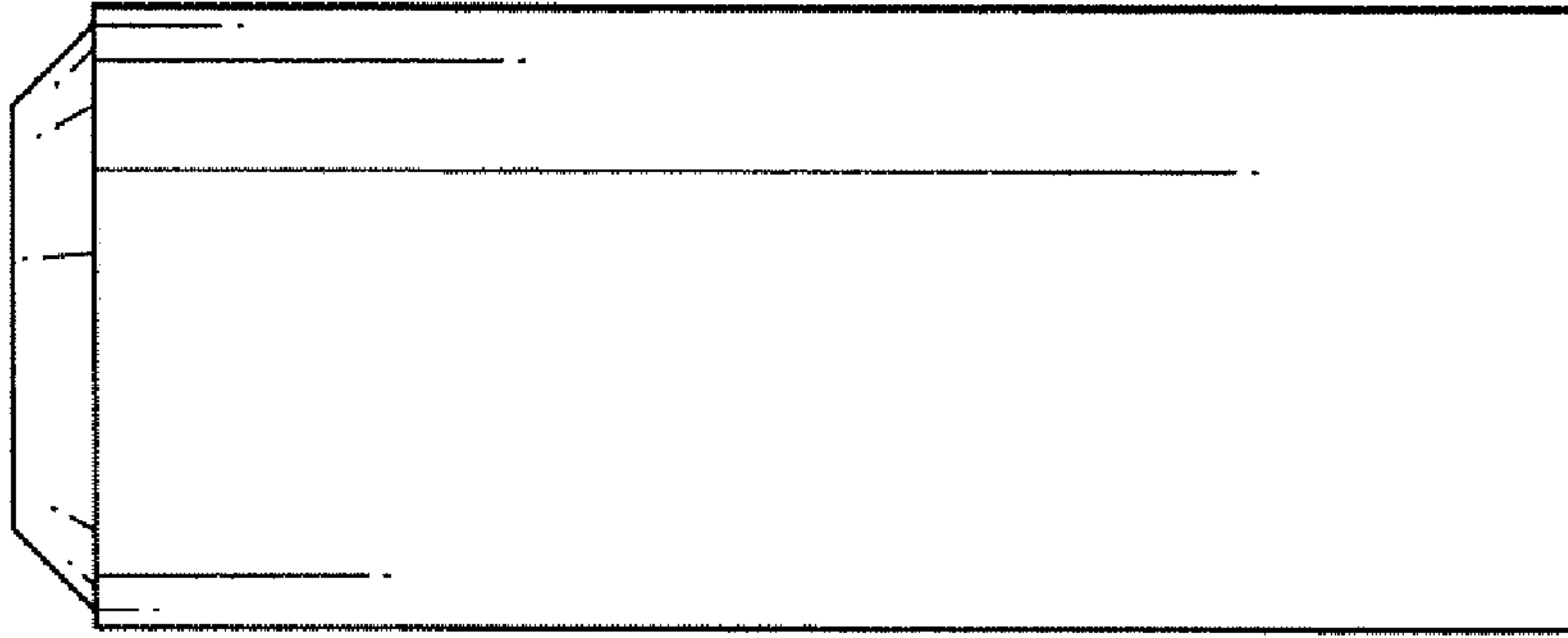

FIG. 6

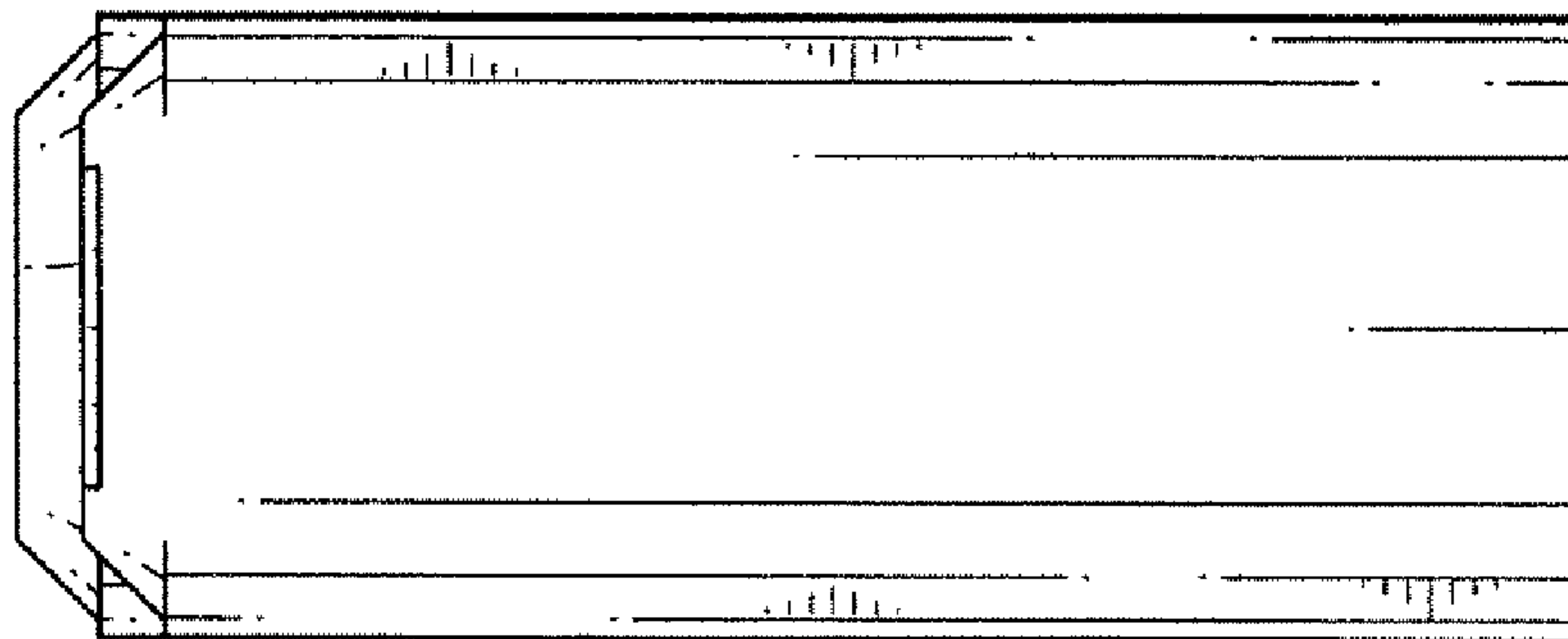

FIG. 5