

US00D661348S

(12) **United States Design Patent**  
**Mayer et al.**

(10) **Patent No.:** **US D661,348 S**  
(45) **Date of Patent:** **\*\* Jun. 5, 2012**

(54) **GREETING CARD**

(76) Inventors: **David Mayer**, Bay Village, OH (US);  
**April Nemeth**, Westlake, OH (US);  
**Gary Nelson**, Avon, OH (US); **Allison Marsh**, Ravenna, OH (US); **Katalina Speck**, Rocky River, OH (US); **David Sapp**, Avon Lake, OH (US)

(\*\*) Term: **14 Years**

(21) Appl. No.: **29/414,846**

(22) Filed: **Mar. 5, 2012**

**Related U.S. Application Data**

(62) Division of application No. 29/404,325, filed on Oct. 19, 2011, now Pat. No. Des. 657,817.

(51) **LOC (9) Cl.** ..... **19-01**

(52) **U.S. Cl.** ..... **D19/1**

(58) **Field of Classification Search** ..... D19/1-12,  
D19/20-34, 100; 40/124.01-124.15, 672,  
40/661, 617, 599, 331, 359, 360, 673, 455,  
40/463, 717, 124.91, 457; 283/2-4, 74-75,  
283/103, 105-106; D20/10, 22, 27, 40, 42;  
229/92, 92.1, 92.8, 300-303; D11/131, 117;  
206/449, 308.3; 383/103; 248/441.1, 460;  
281/15.1, 51; D6/300, 309; 434/311, 317,  
434/319

See application file for complete search history.

(56) **References Cited**

**U.S. PATENT DOCUMENTS**

2,742,287 A \* 4/1956 Barker ..... 446/150  
4,484,768 A \* 11/1984 Norfleet ..... 283/116  
5,139,454 A \* 8/1992 Earnest ..... 446/150

D432,570 S \* 10/2000 Donaldson ..... D19/2  
6,523,285 B1 \* 2/2003 Gilson et al. .... 40/124.03  
6,848,965 B2 \* 2/2005 Wong ..... 446/150  
D616,929 S \* 6/2010 Krivanek et al. .... D19/1  
7,802,386 B2 \* 9/2010 Mandelbaum et al. .... 40/124.03  
D632,330 S \* 2/2011 Qiao et al. .... D19/1

\* cited by examiner

*Primary Examiner* — Caron D Veynar

*Assistant Examiner* — Abraham Bahta

(74) *Attorney, Agent, or Firm* — Roetzel & Andress; James C. Scott

(57) **CLAIM**

The ornamental designs for a greeting card, as shown and described.

**DESCRIPTION**

FIG. 1 is a perspective view of the greeting card of the present invention, in a closed position.

FIG. 2 is a front view of the greeting card of FIG. 1.

FIG. 3 is a rear view of the greeting card of FIG. 1.

FIG. 4 is a right side view of the greeting card of FIG. 1.

FIG. 5 is a left side view of the greeting card of FIG. 1.

FIG. 6 is a top view of the greeting card of FIG. 1.

FIG. 7 is a bottom view of the greeting card of FIG. 1.

FIG. 8 is a perspective view of the greeting card of FIG. 1, in an open position.

FIG. 9 is a right side view of the greeting card of FIG. 8, the left side of which is a mirror image thereof.

FIG. 10 is a front view of the greeting card of FIG. 8.

FIG. 11 is a rear view of the greeting card of FIG. 8.

FIG. 12 is a top view of the greeting card of FIG. 8; and,

FIG. 13 is a bottom view of the greeting card of FIG. 8.

The broken line showing of portions of the greeting card included for the purpose of illustrating environmental structure and forms no part of the claimed design.

**1 Claim, 6 Drawing Sheets**

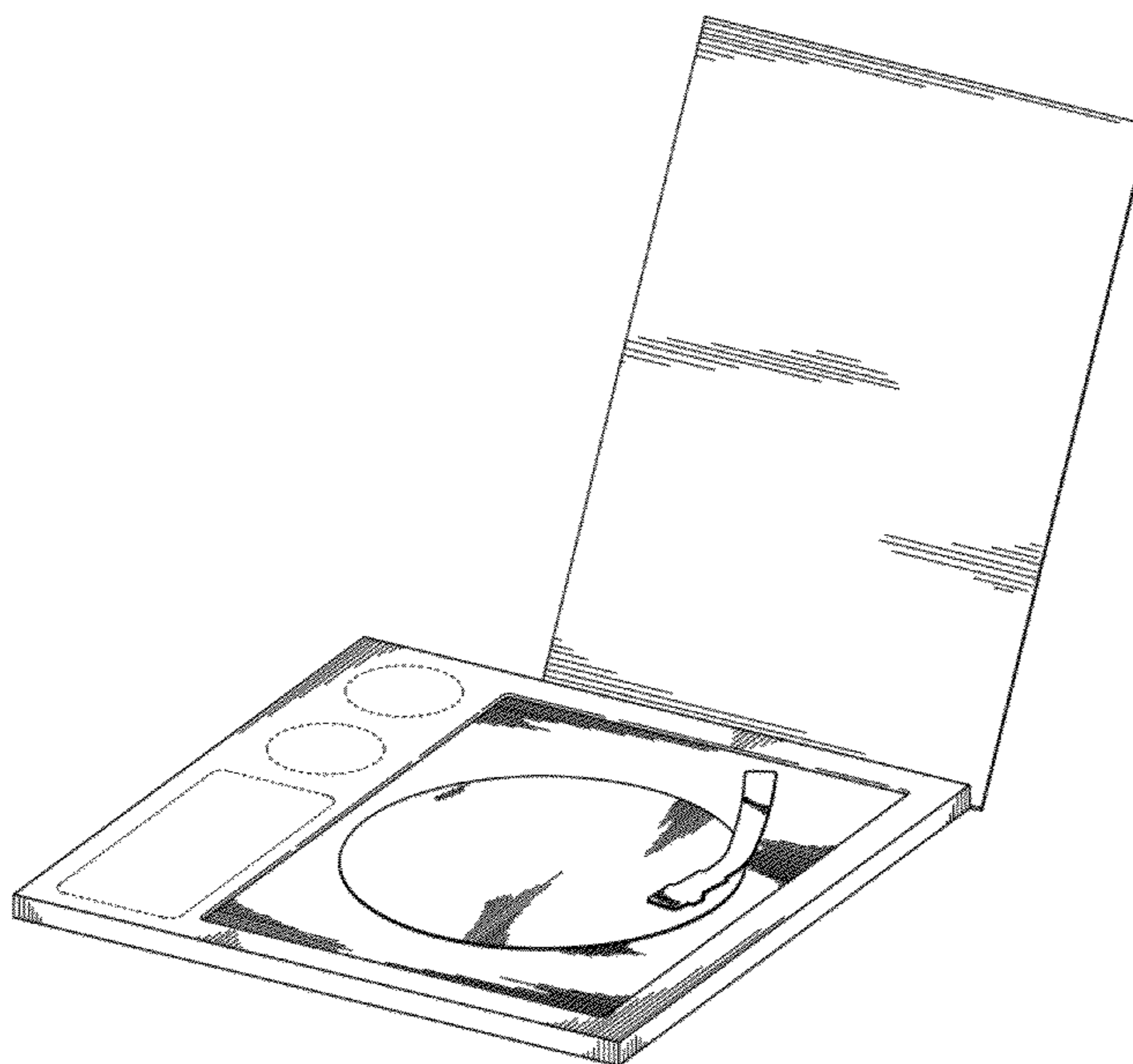

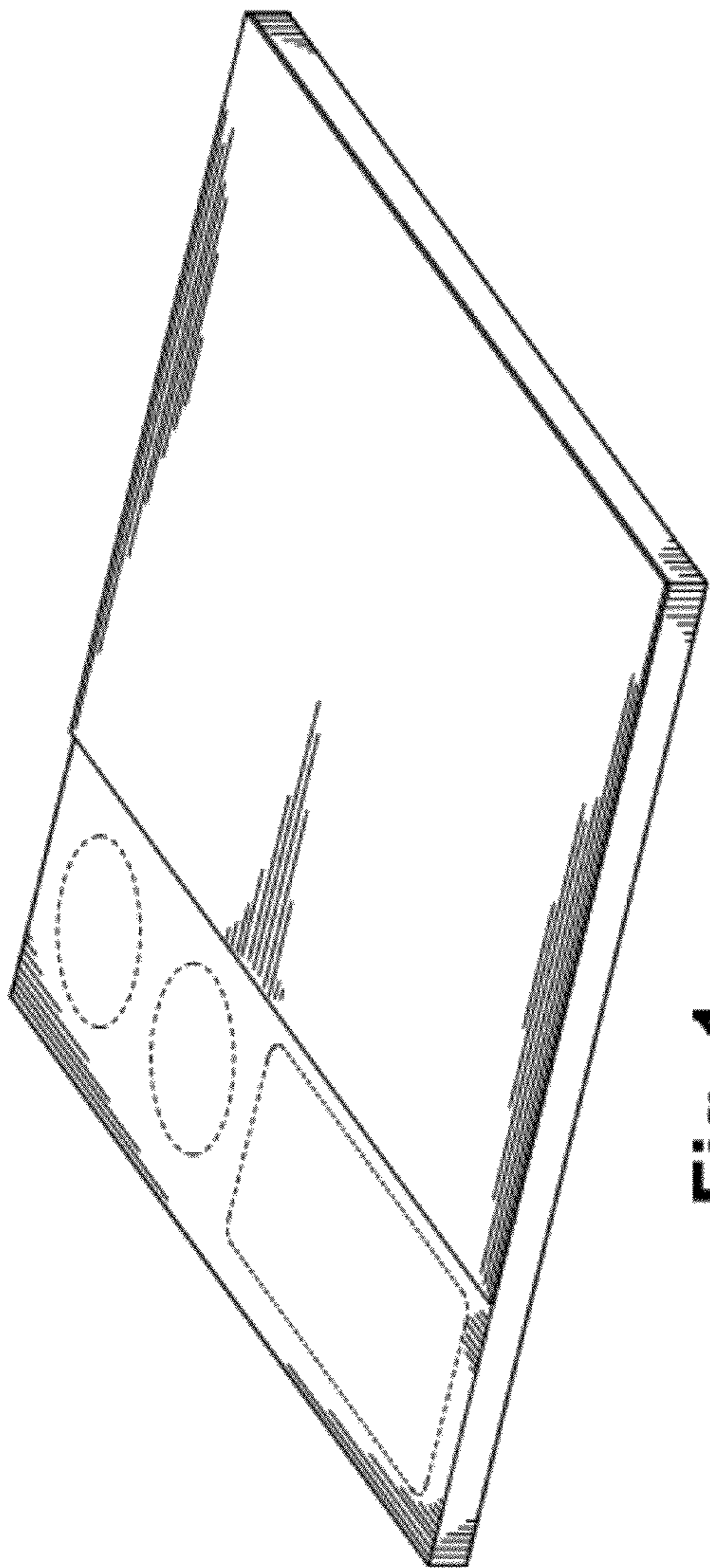

Fig. 1



Fig. 2



Fig. 4



Fig. 3



Fig. 5

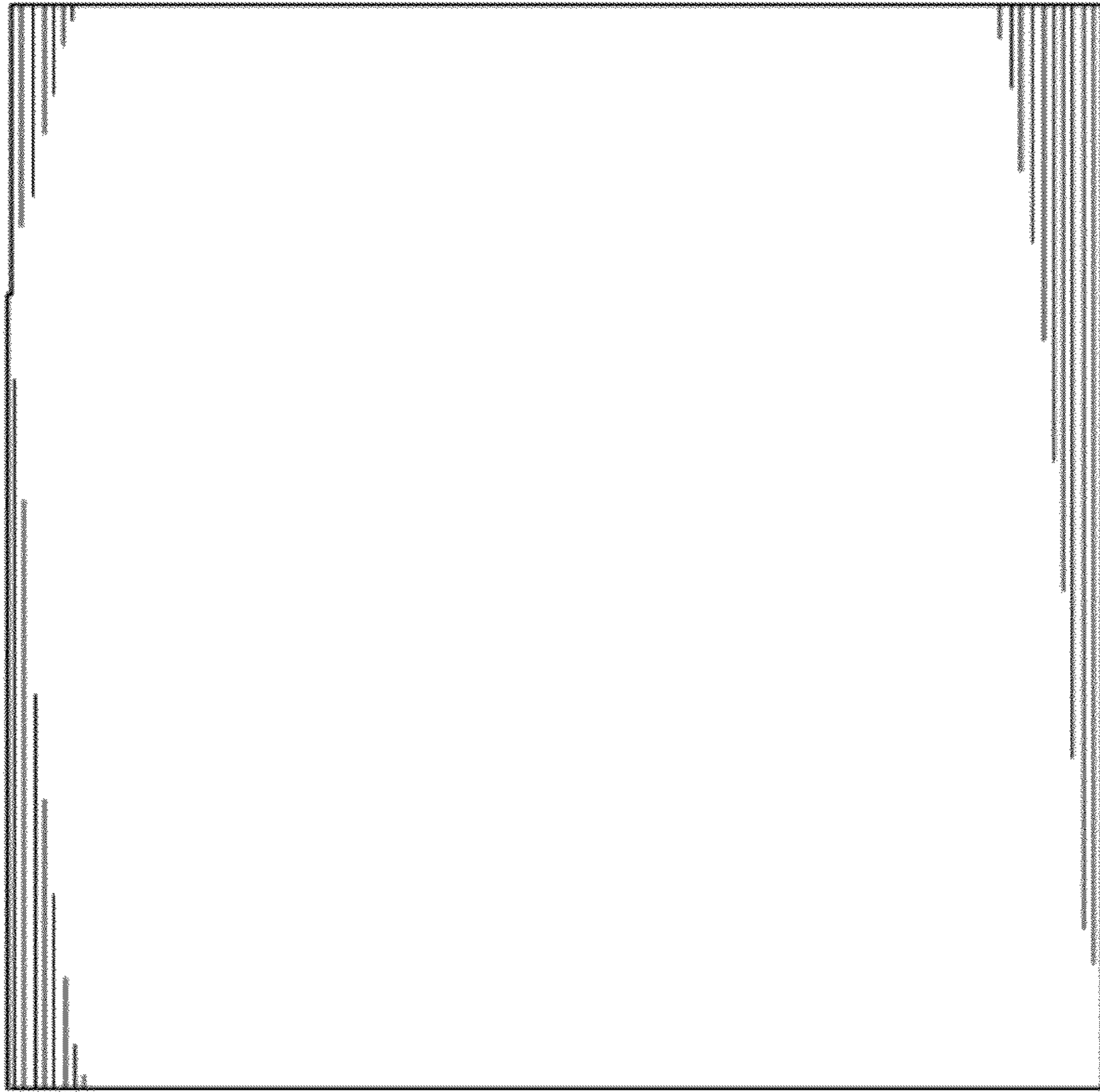

Fig. 7

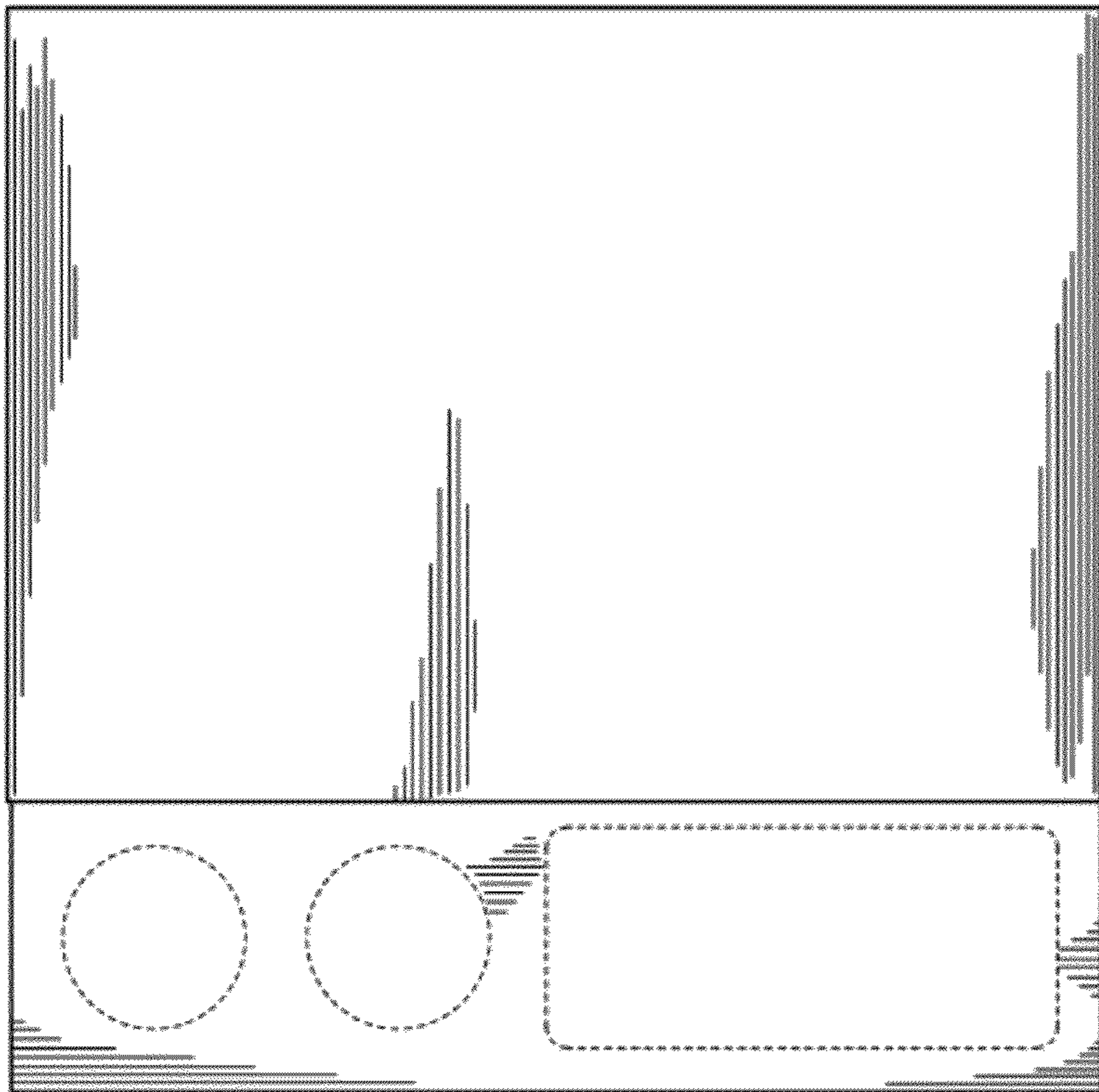

Fig. 6

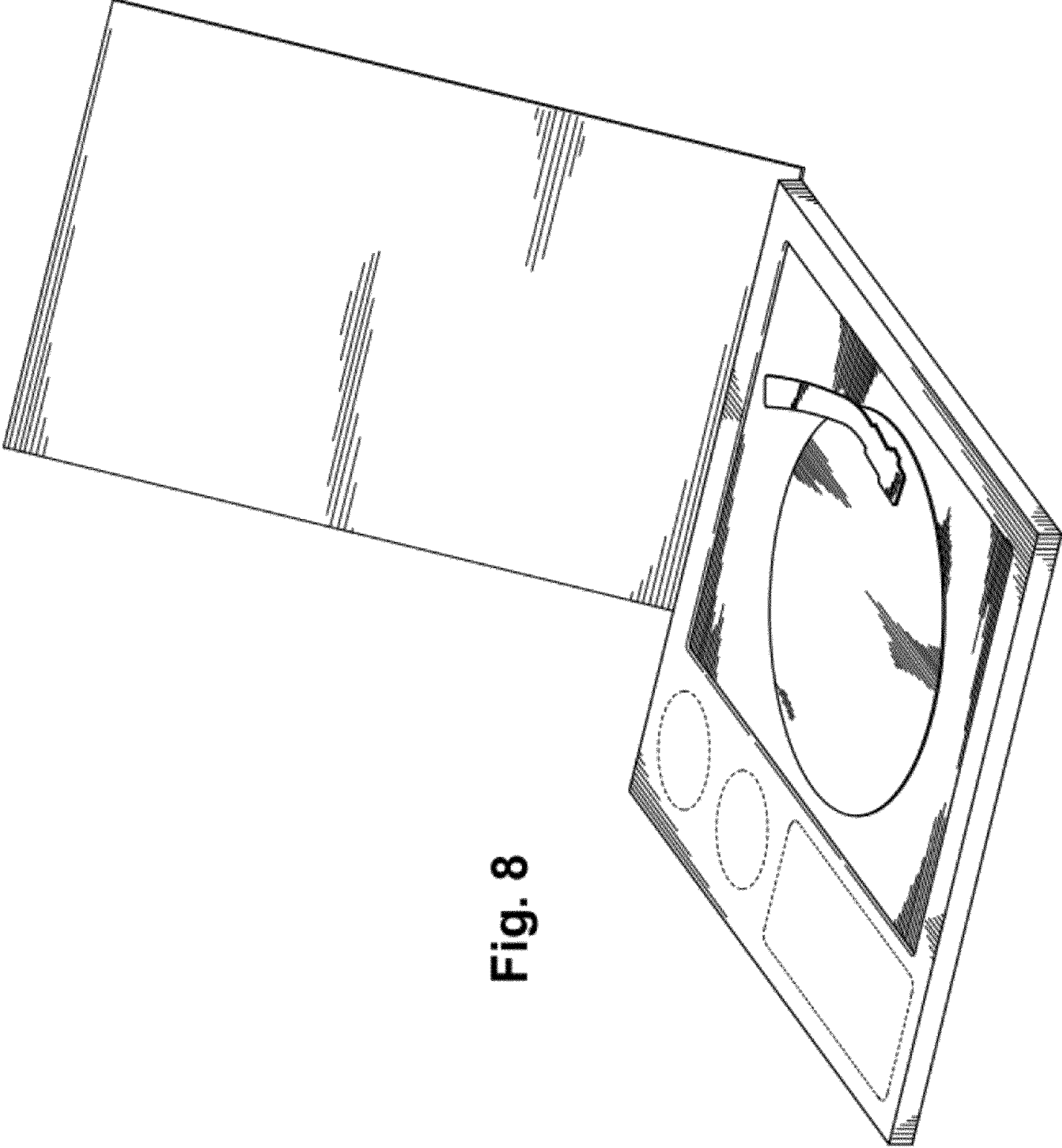

Fig. 8

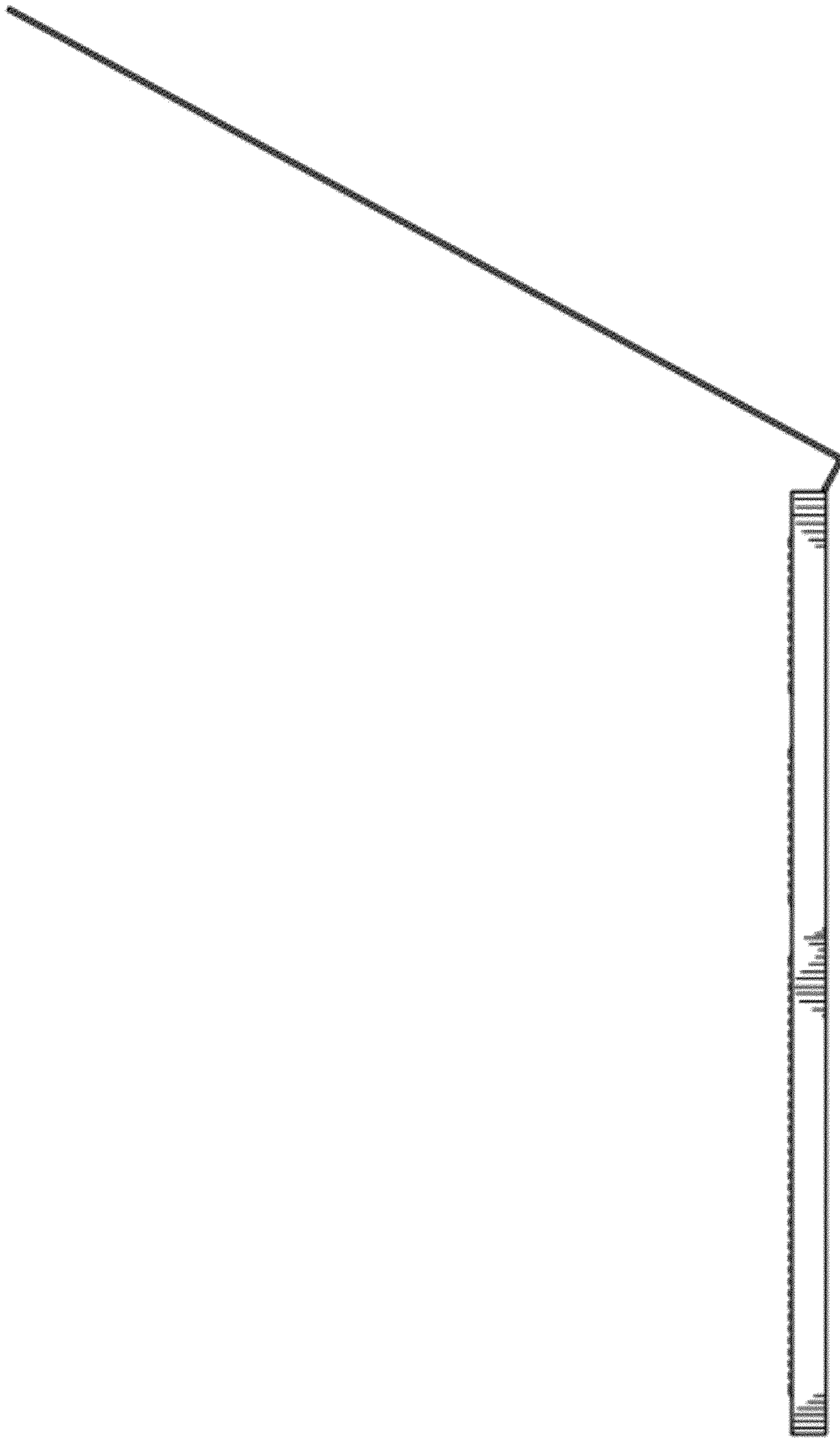

Fig. 9

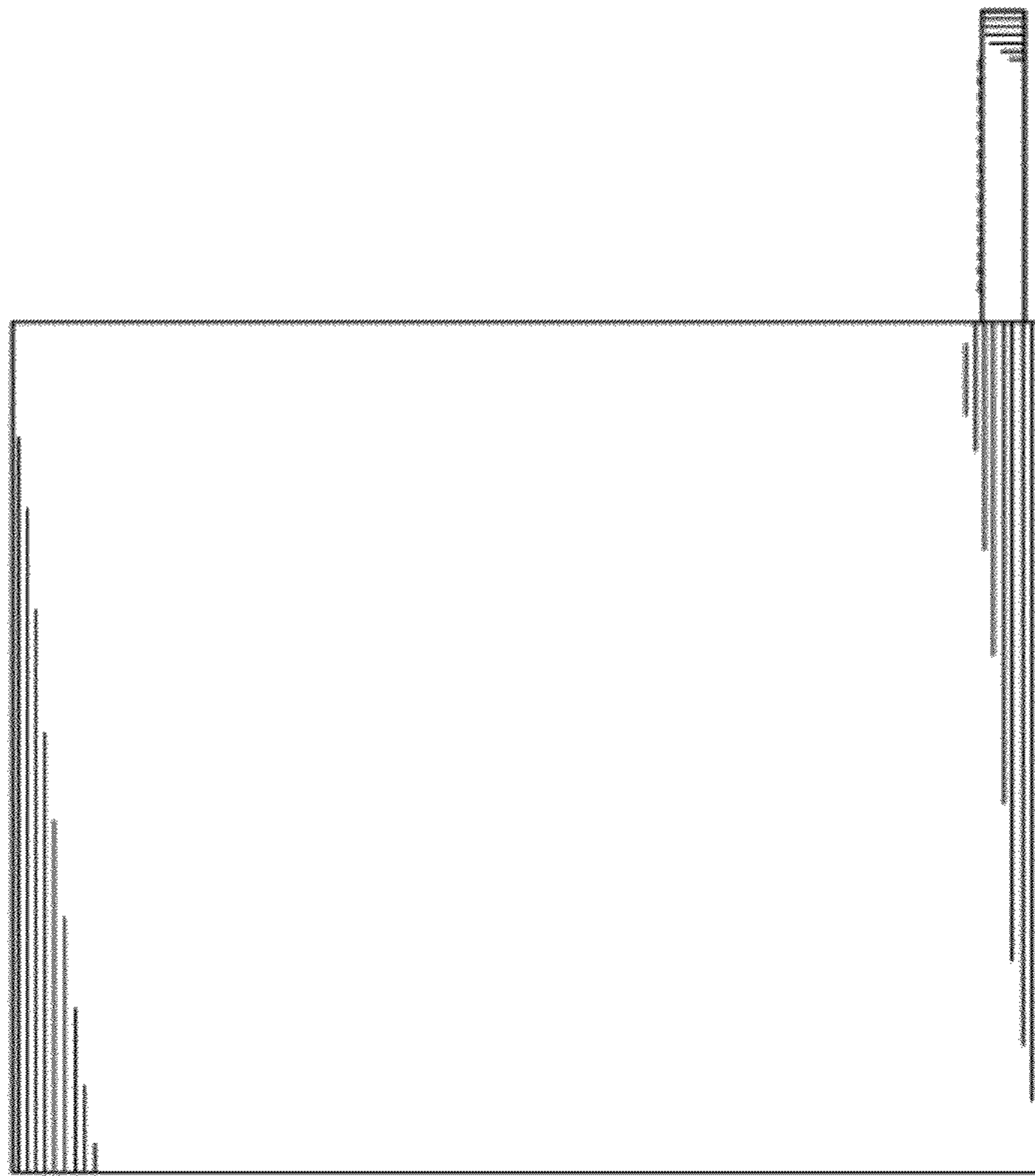

Fig. 11

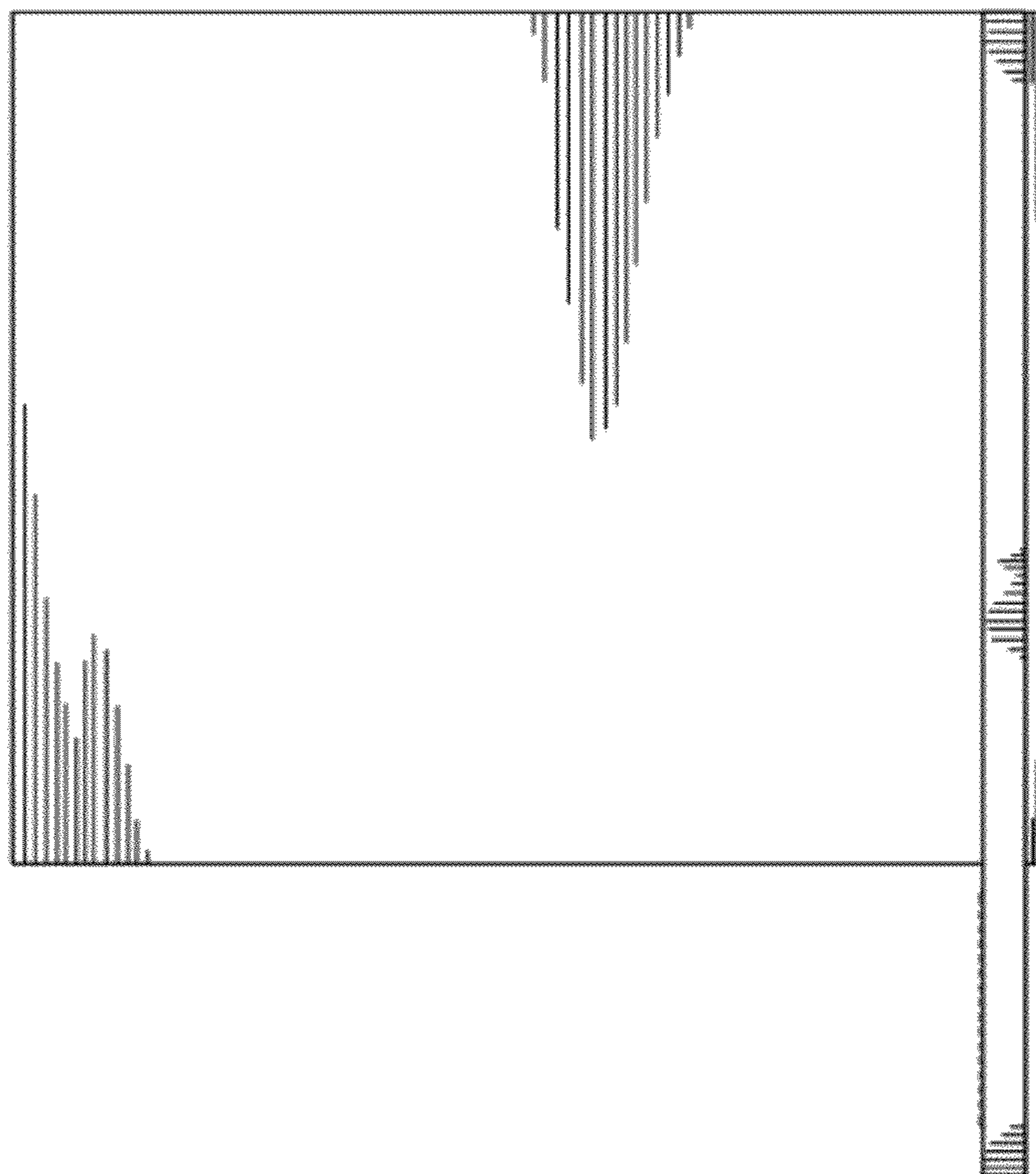

Fig. 10

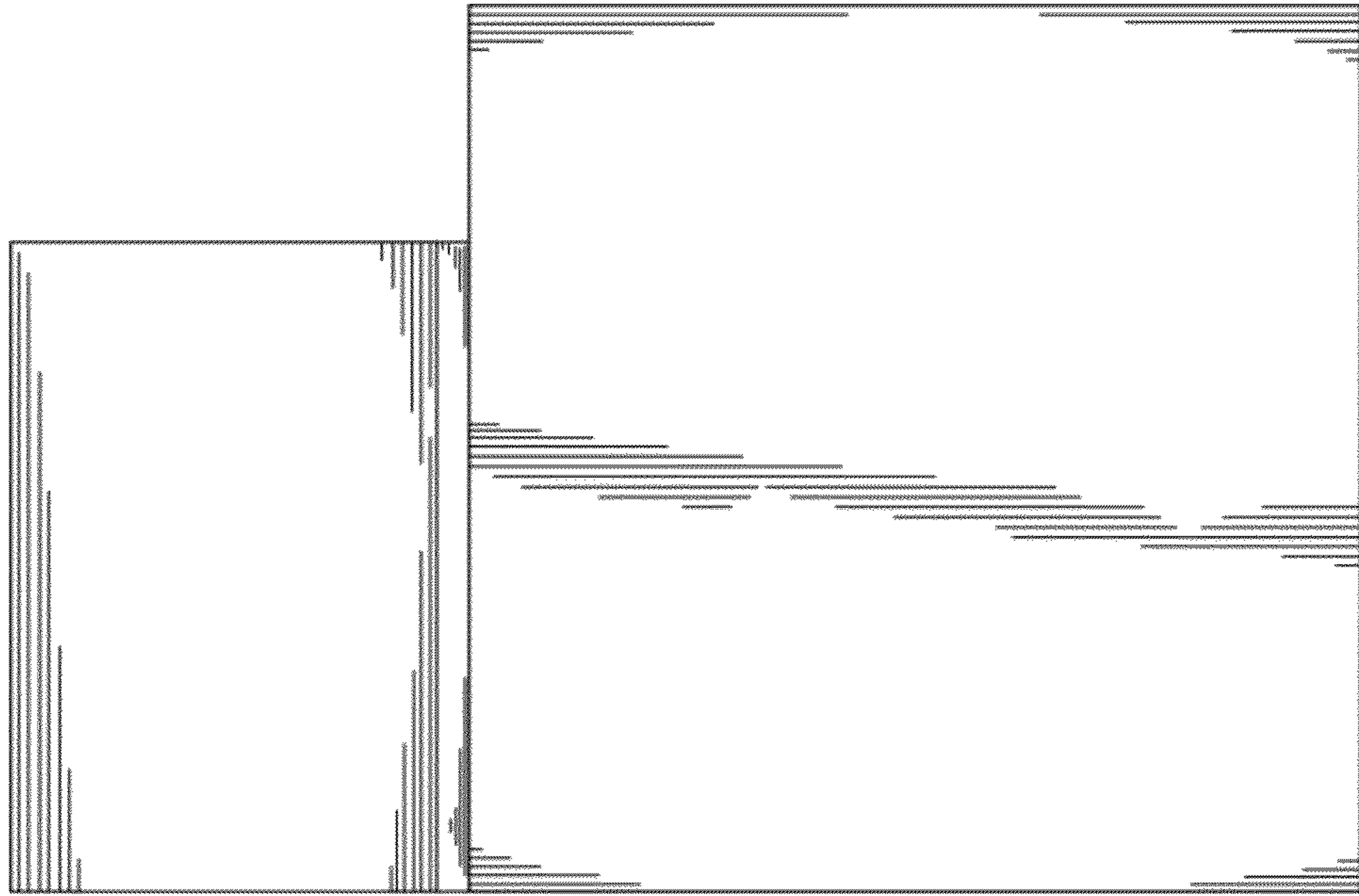

Fig. 13

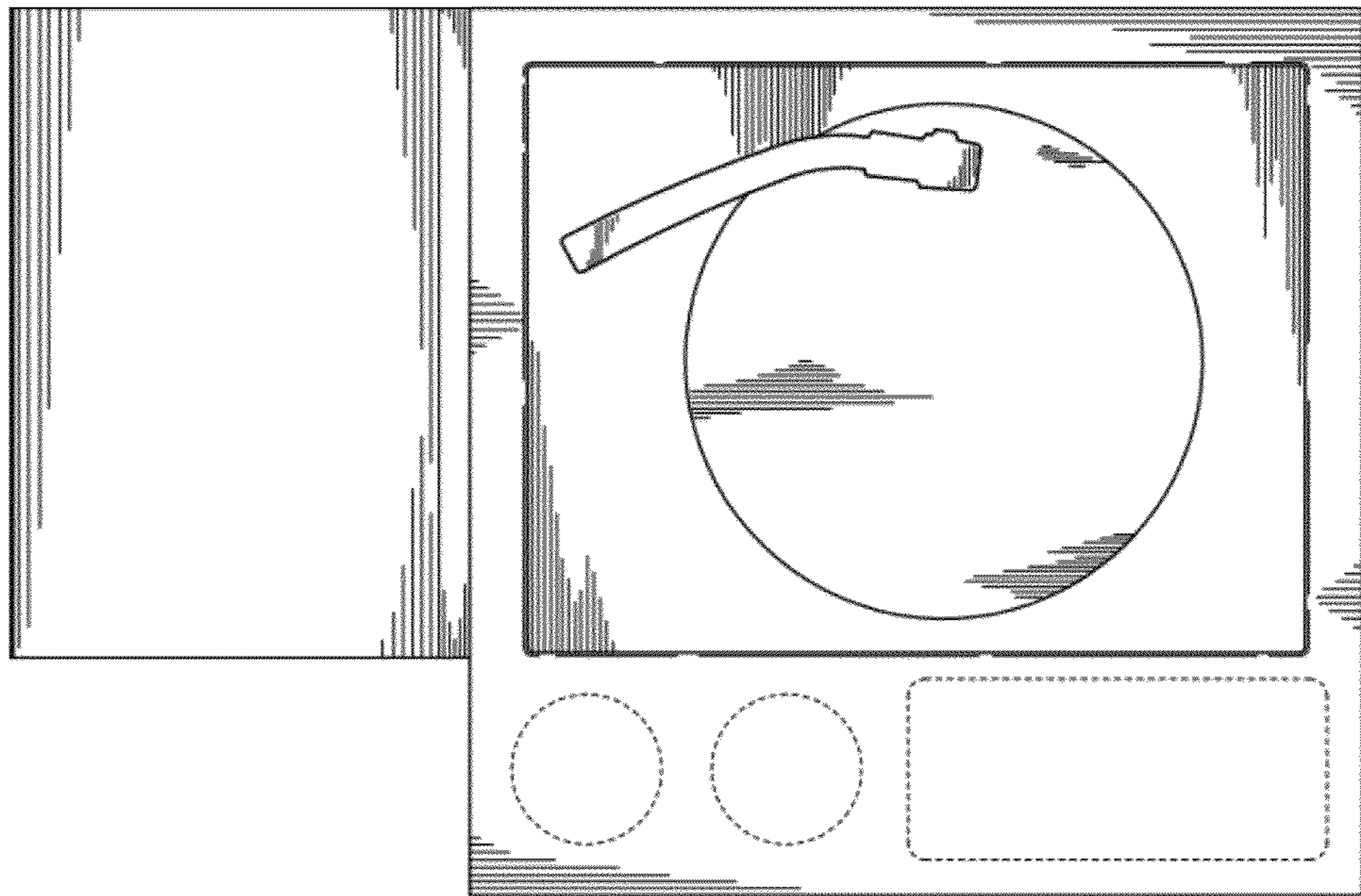

Fig. 12