



US00D661332S

(12) **United States Design Patent**
Nakayama et al.

(10) **Patent No.:** **US D661,332 S**
(45) **Date of Patent:** **** Jun. 5, 2012**

(54) **PROJECTOR**

(75) Inventors: **Tetsu Nakayama**, Matsumoto (JP);
Hiroto Miyauchi, Matsumoto (JP);
Yoshihiro Tatara, Matsumoto (JP);
Yasutomo Takahashi, Matsumoto (JP);
Toshimitsu Watanabe, Matsumoto (JP);
Masaaki Miyashita, Okaya (JP);
Yoshinori Hashimoto, Shiojiri (JP);
Kenichi Asami, Azumino (JP)

(73) Assignee: **Seiko Epson Corporation**, Tokyo (JP)

(**) Term: **14 Years**

(21) Appl. No.: **29/403,608**

(22) Filed: **Oct. 7, 2011**

(30) **Foreign Application Priority Data**

May 11, 2011 (JP) 2011-010481

(51) **LOC (9) Cl.** **16-02**

(52) **U.S. Cl.** **D16/230; D16/225**

(58) **Field of Classification Search** D16/208,
D16/221, 225, 230-231, 234; D21/514;
353/115, 119, 122

See application file for complete search history.

(56) **References Cited**

U.S. PATENT DOCUMENTS

D391,592 S * 3/1998 Sakamoto et al. D16/231
D557,318 S * 12/2007 Nishimura et al. D16/230
D588,619 S * 3/2009 Kawabe et al. D16/230

D588,620 S * 3/2009 Kawabe et al. D16/230
D606,110 S * 12/2009 Inoue et al. D16/230
D640,302 S * 6/2011 Tatara et al. D16/230
D640,303 S * 6/2011 Tatara et al. D16/230
7,997,741 B2 * 8/2011 Nakamura et al. 353/119

* cited by examiner

Primary Examiner — Wan Laymon

(74) *Attorney, Agent, or Firm* — Oliff & Berridge, PLC

(57) **CLAIM**

The ornamental design for a projector, as shown and described.

DESCRIPTION

FIG. 1 is a top, front, right-side perspective view of a projector;
FIG. 2 is a top, rear, left-side perspective view thereof;
FIG. 3 is front view thereof;
FIG. 4 is a rear view thereof;
FIG. 5 is a left-side view thereof;
FIG. 6 is a right-side view thereof;
FIG. 7 is a top view thereof;
FIG. 8 is a bottom view thereof;
FIG. 9 is another perspective view thereof in which a cover partially covers the lens;
FIG. 10 is another front view thereof in which the cover partially covers the lens;
FIG. 11 is another perspective view thereof in which the cover fully covers the lens; and,
FIG. 12 is another front view thereof in which the cover fully covers the lens.

1 Claim, 6 Drawing Sheets

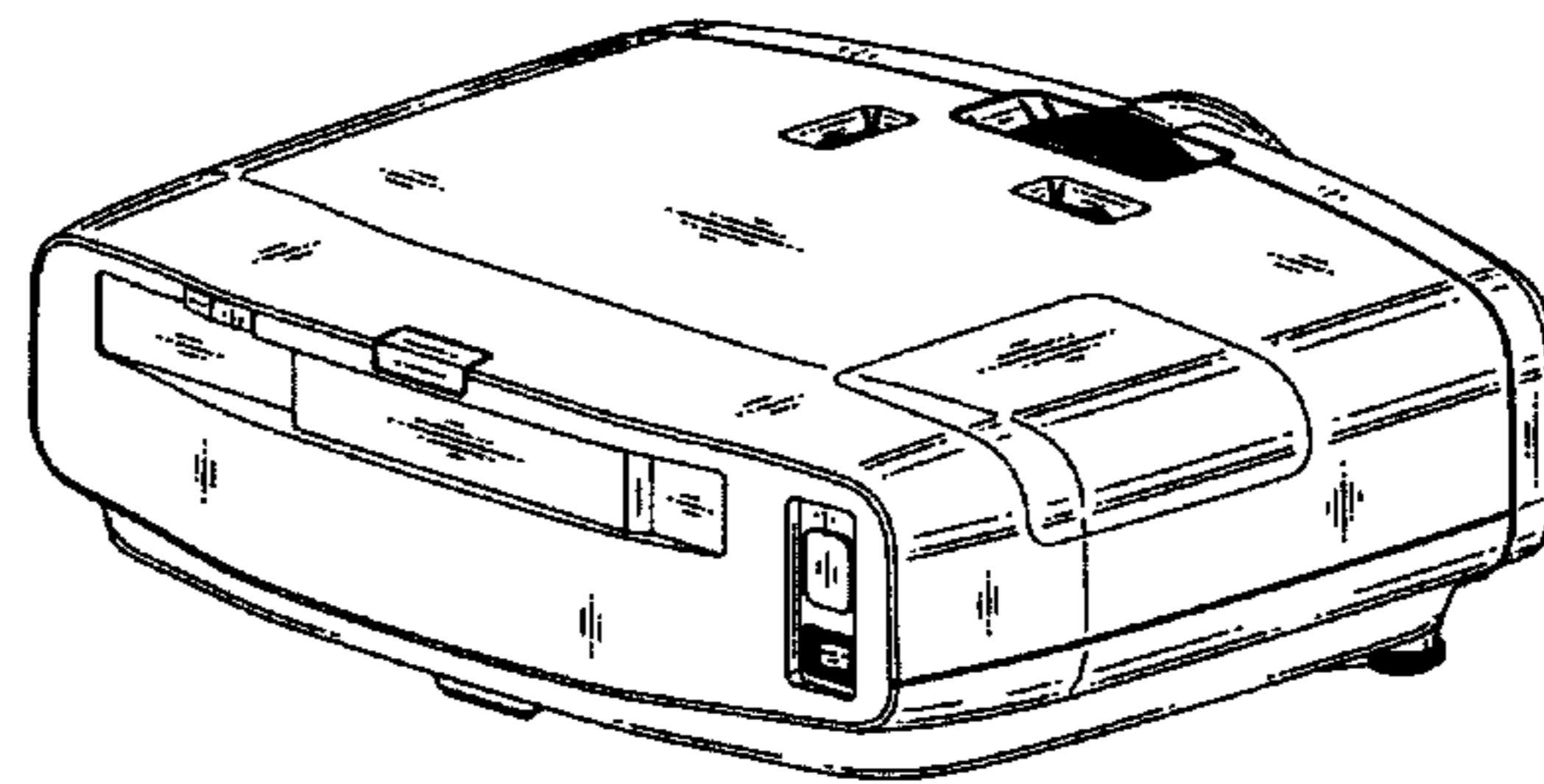
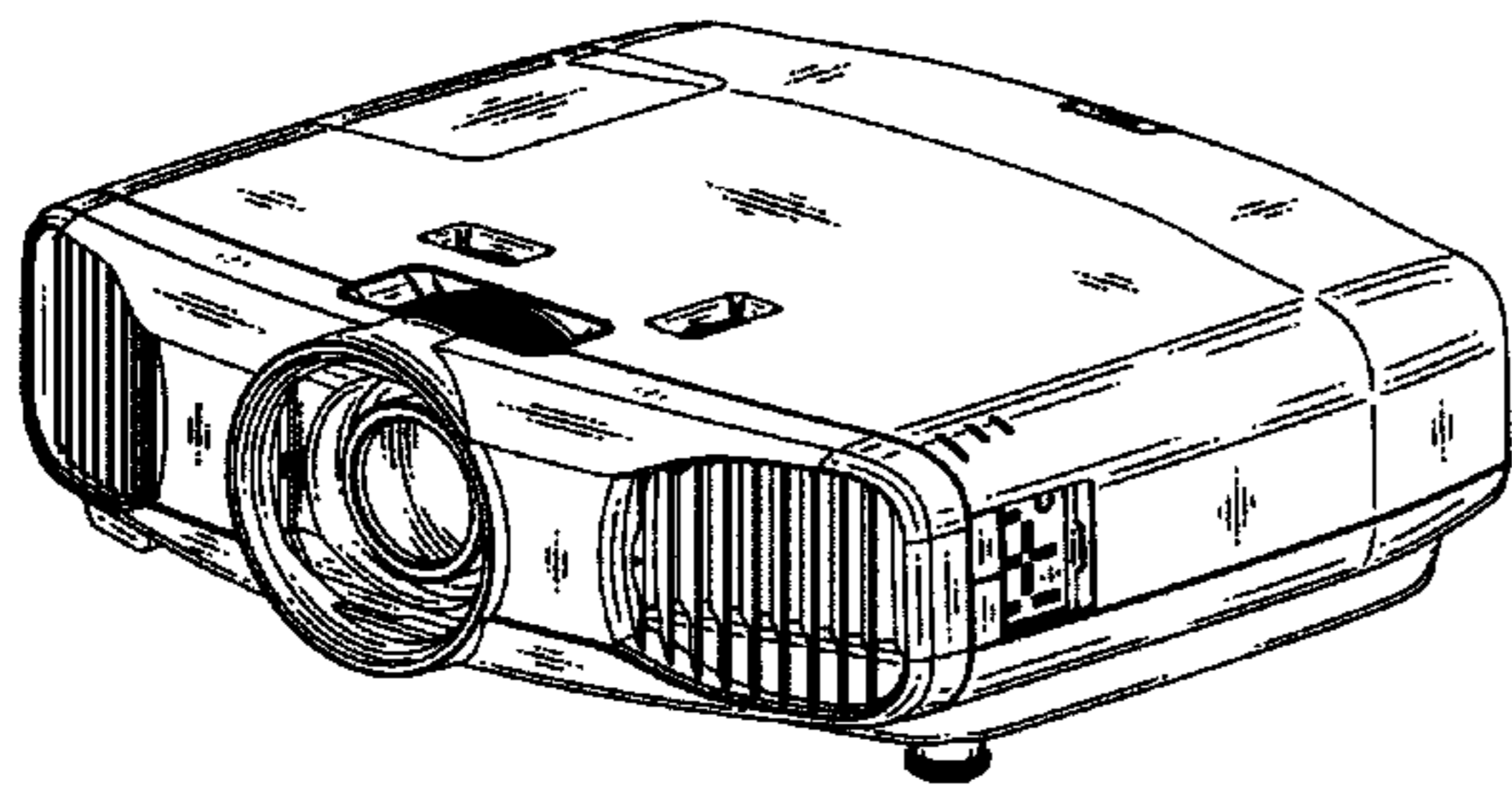

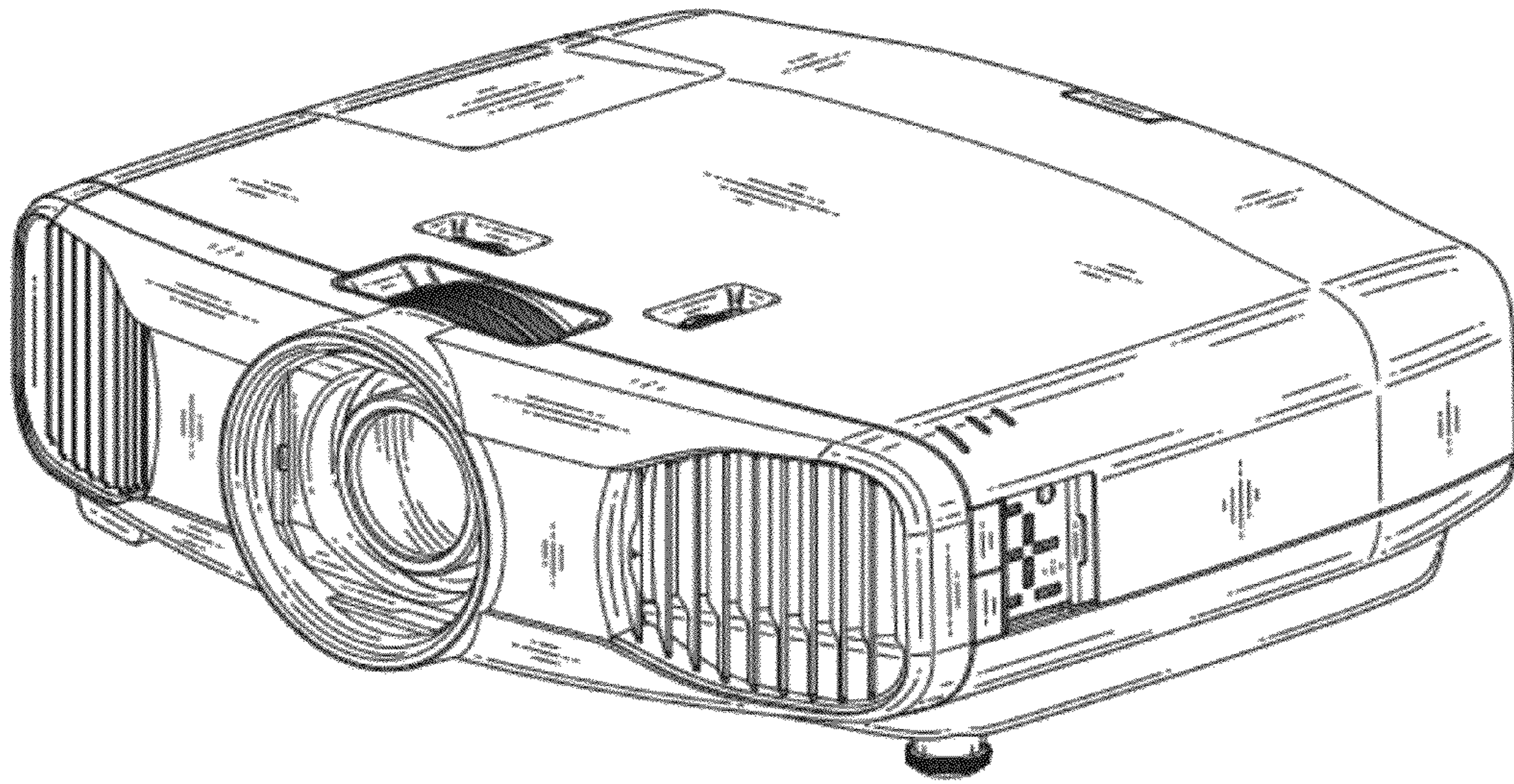

FIG. 1

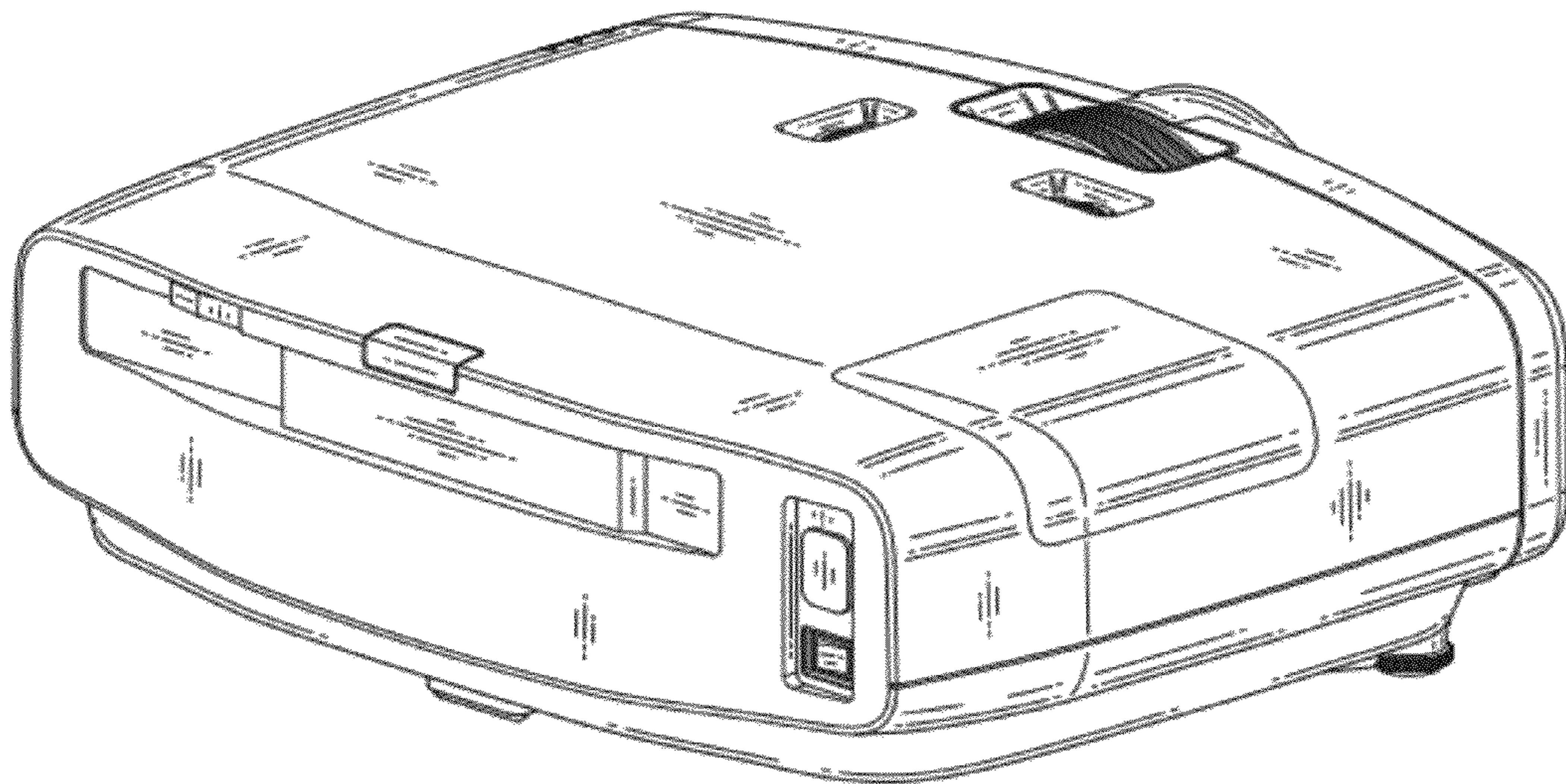

FIG. 2

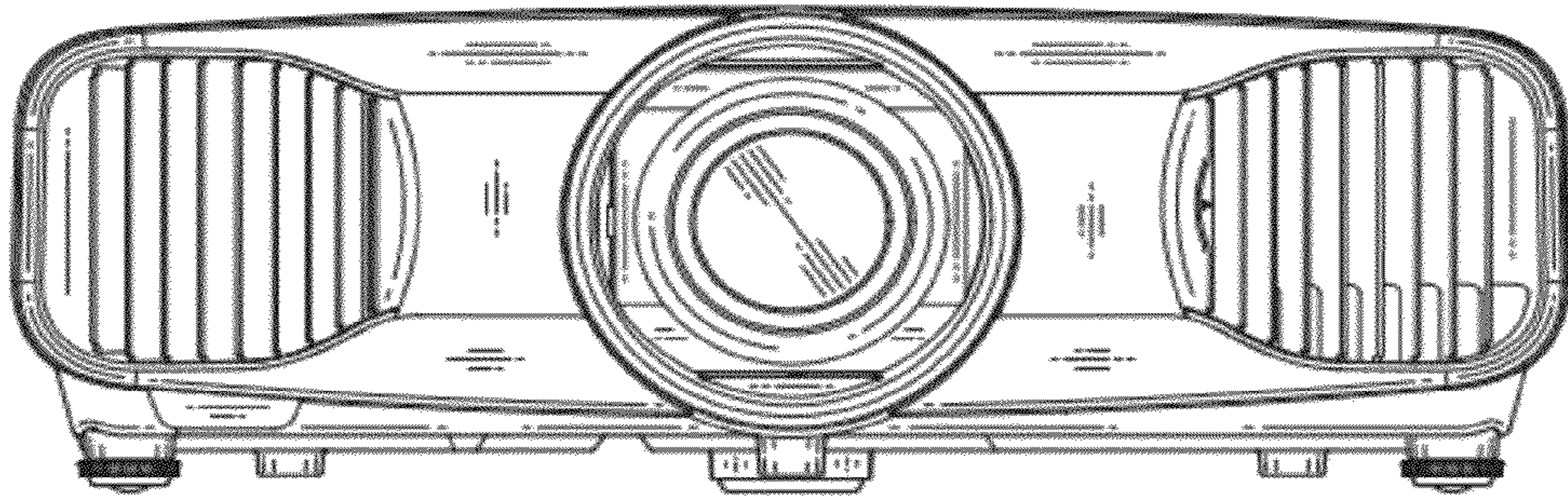

FIG. 3

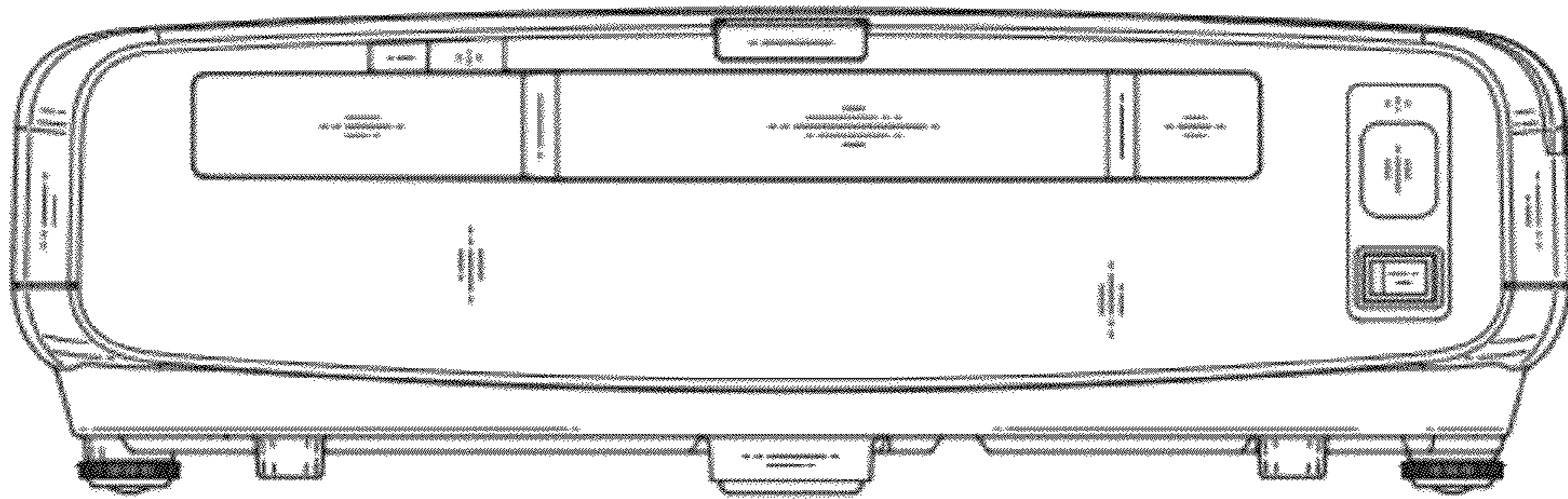

FIG. 4

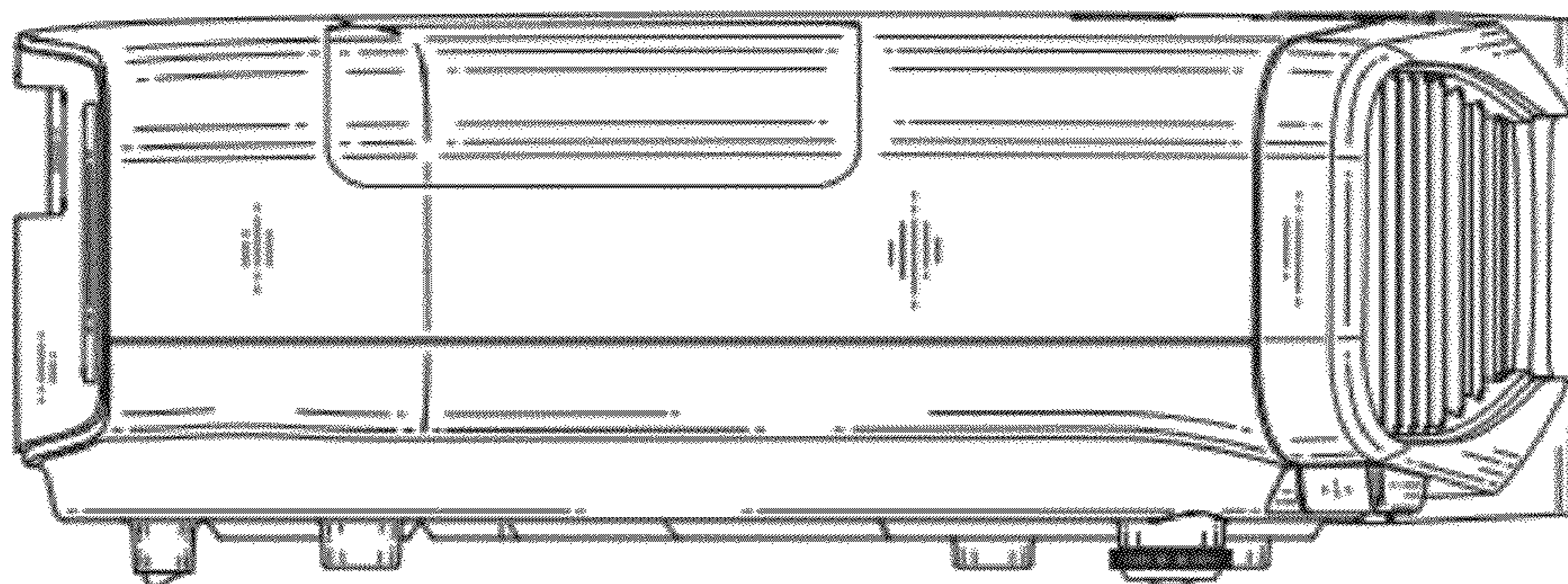

FIG. 5

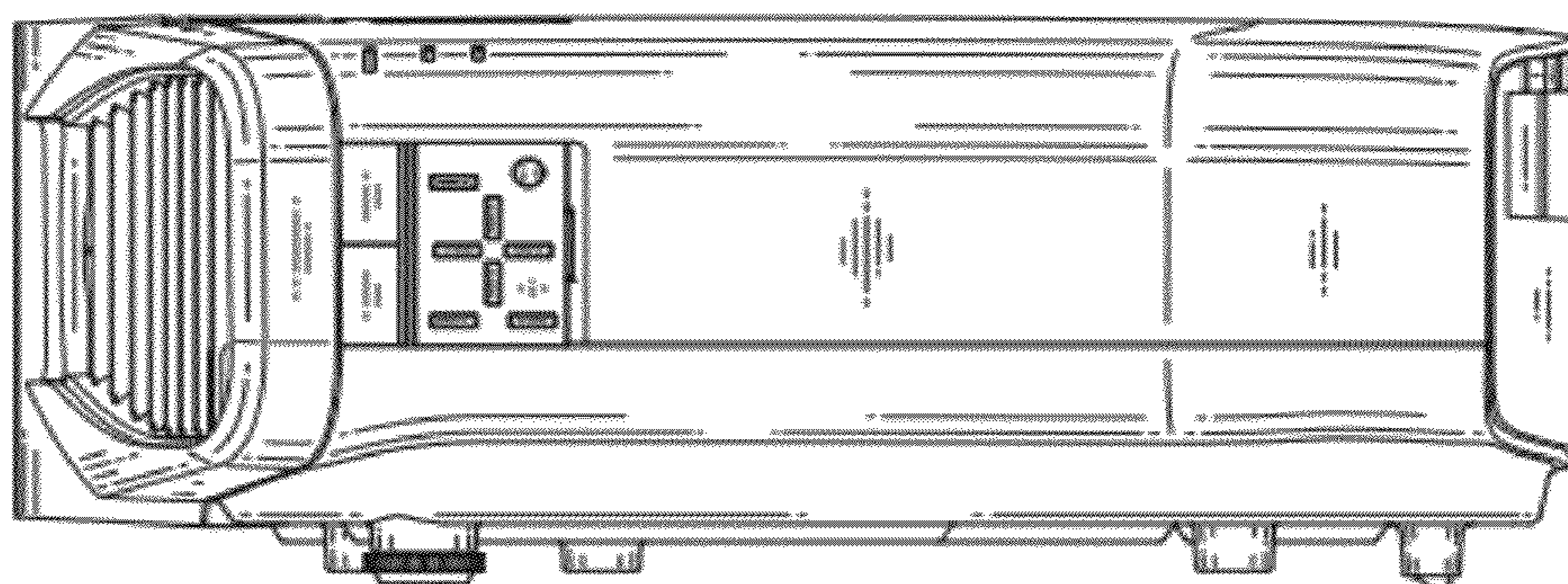

FIG. 6

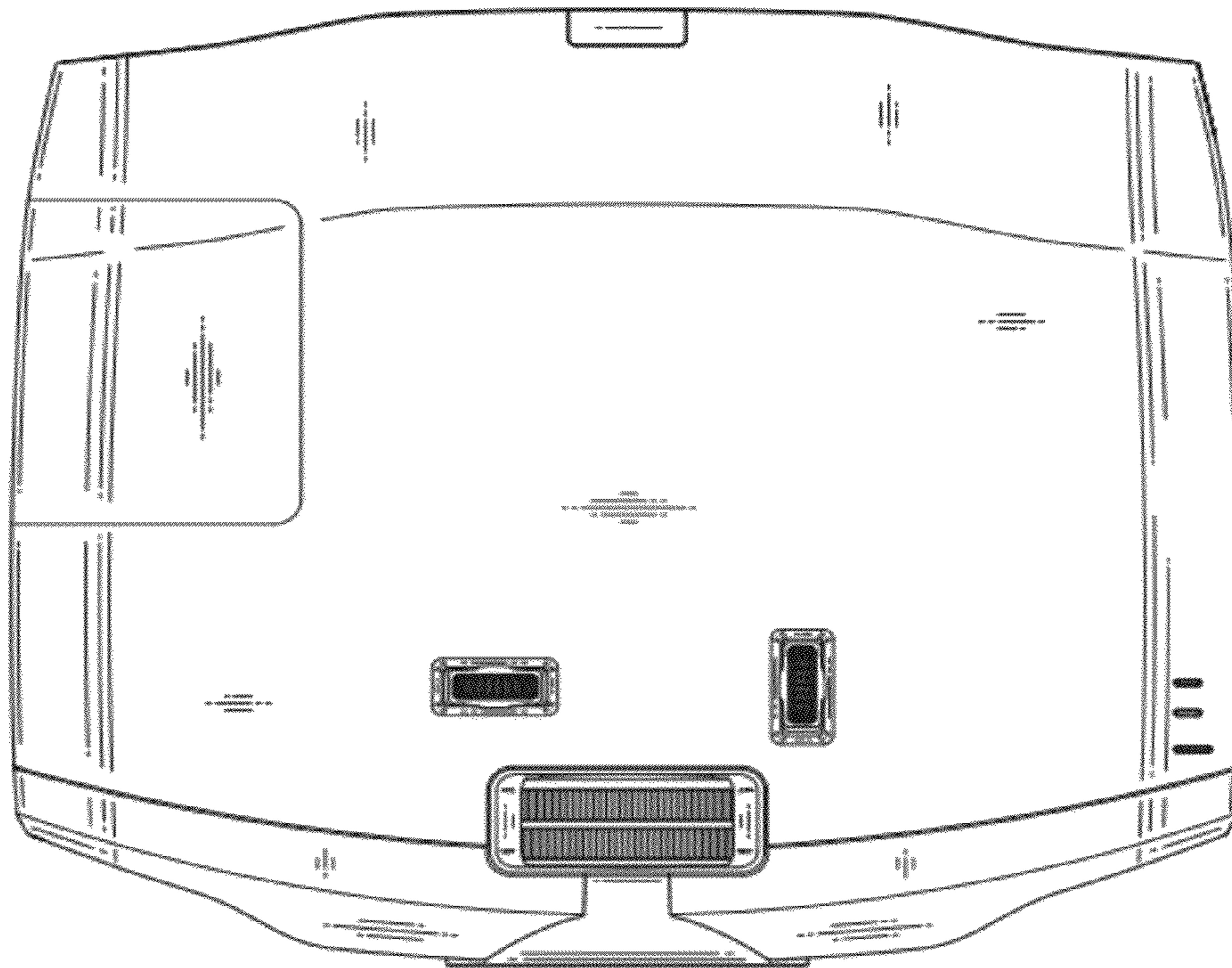

FIG. 7

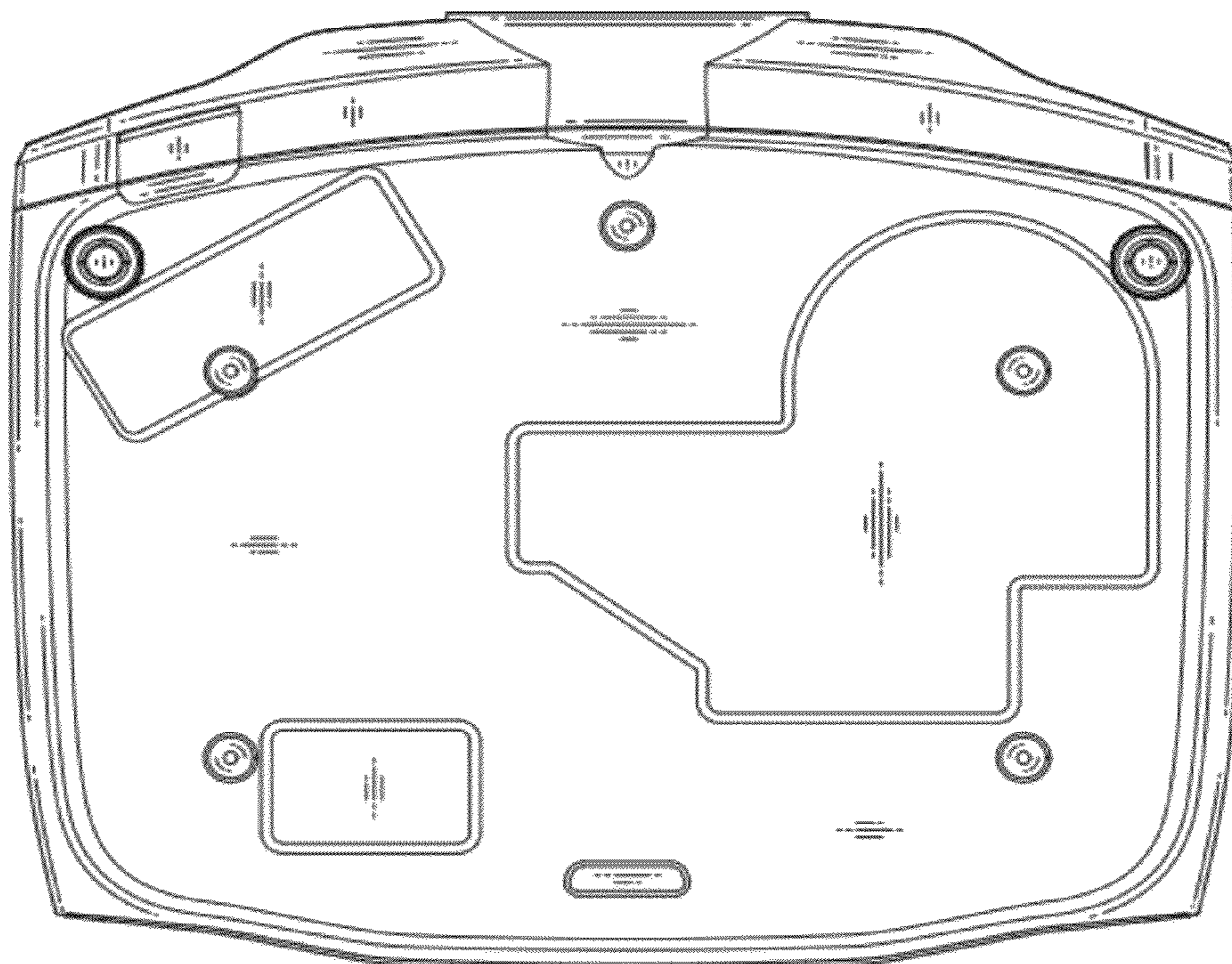

FIG. 8

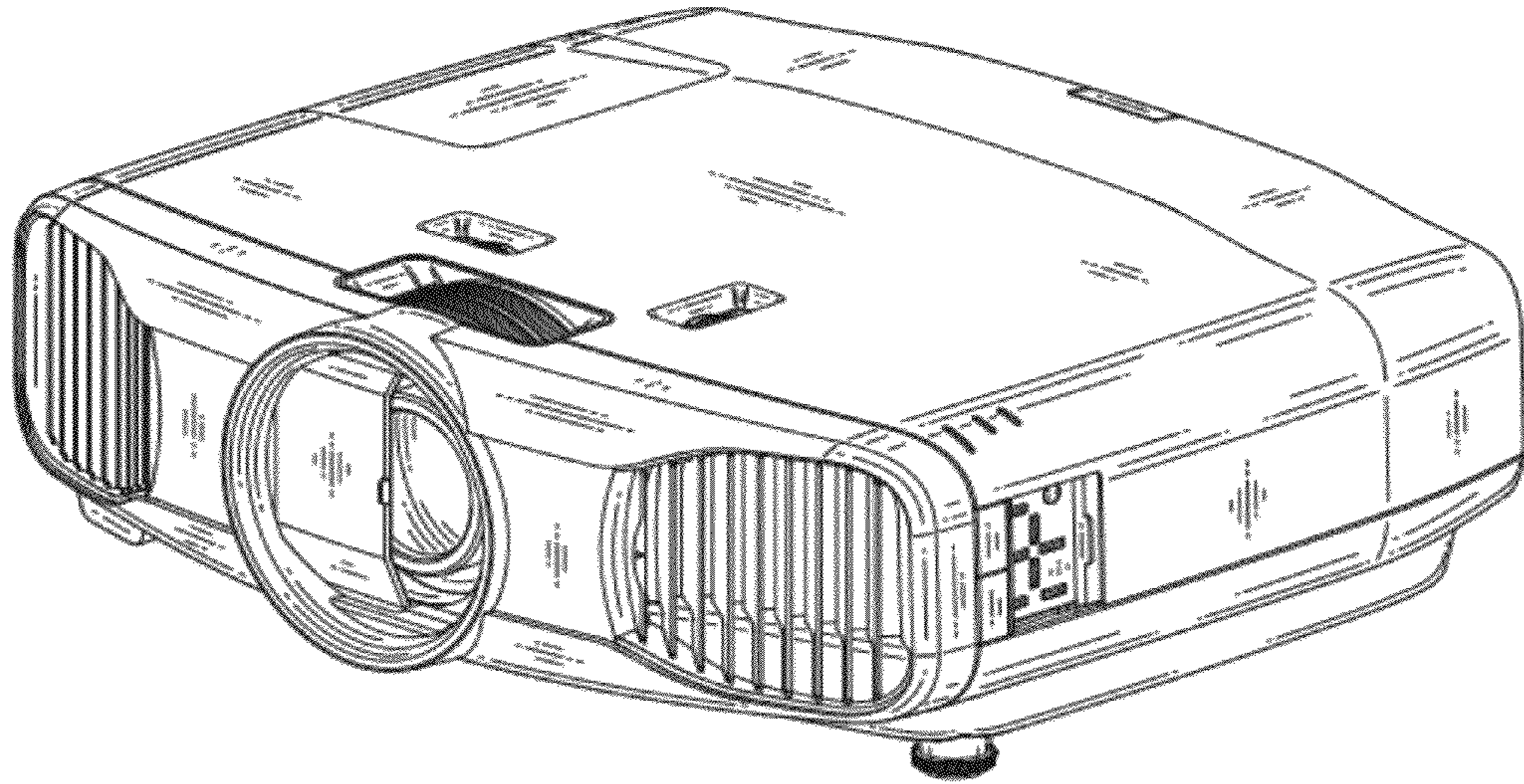

FIG. 9

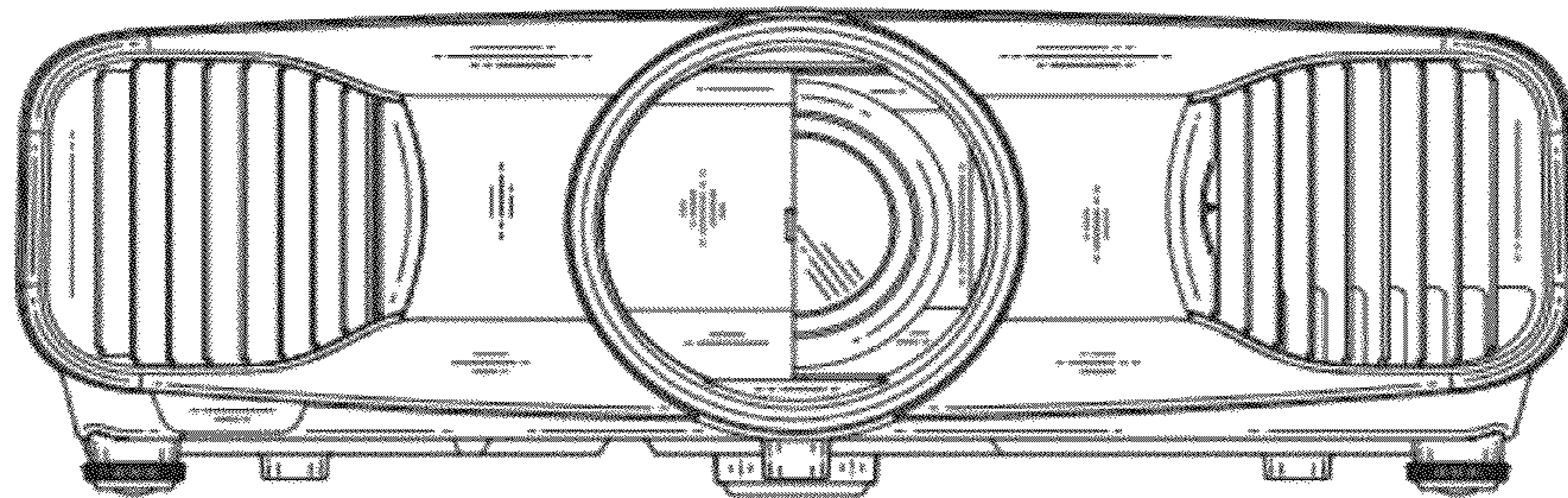

FIG. 10

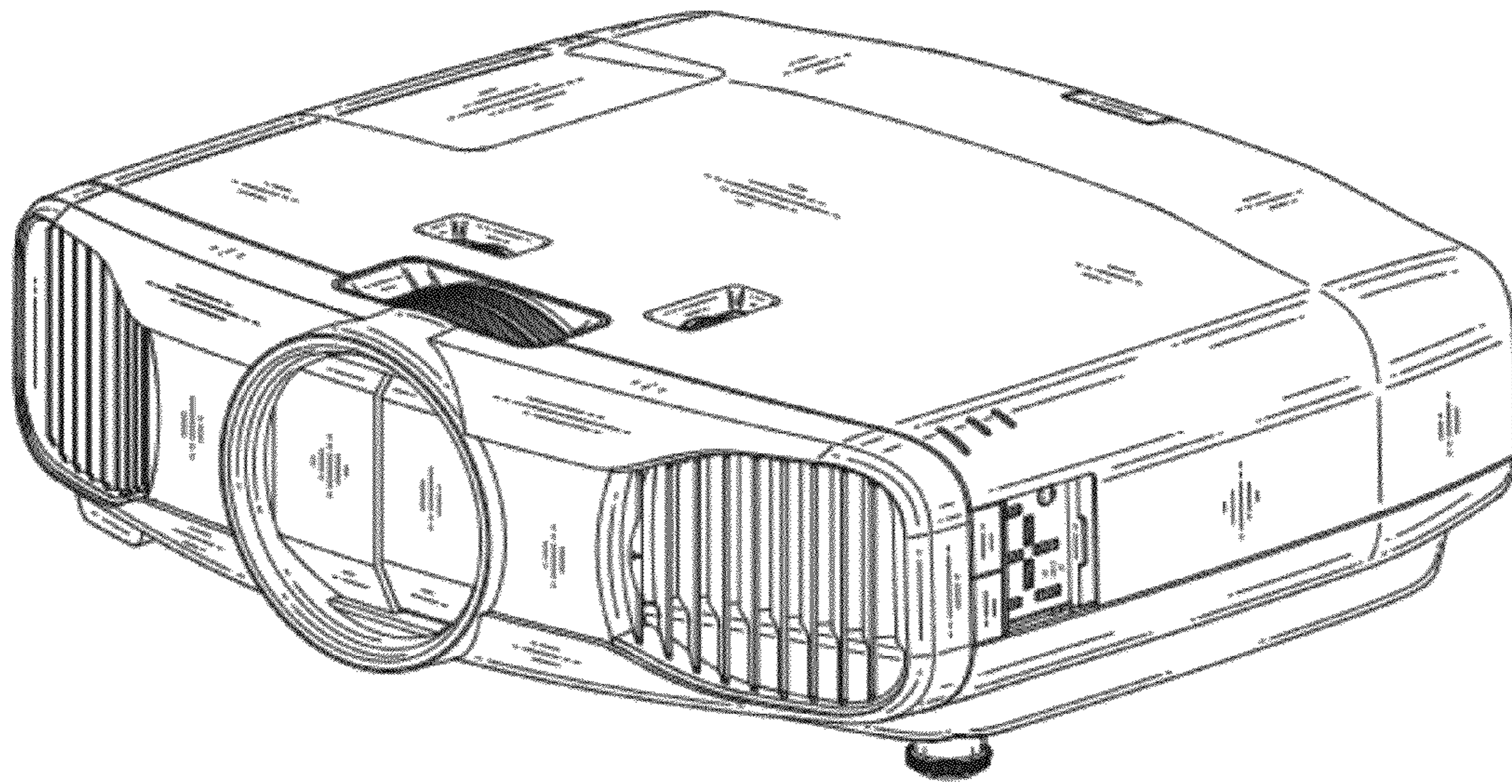

FIG. 11

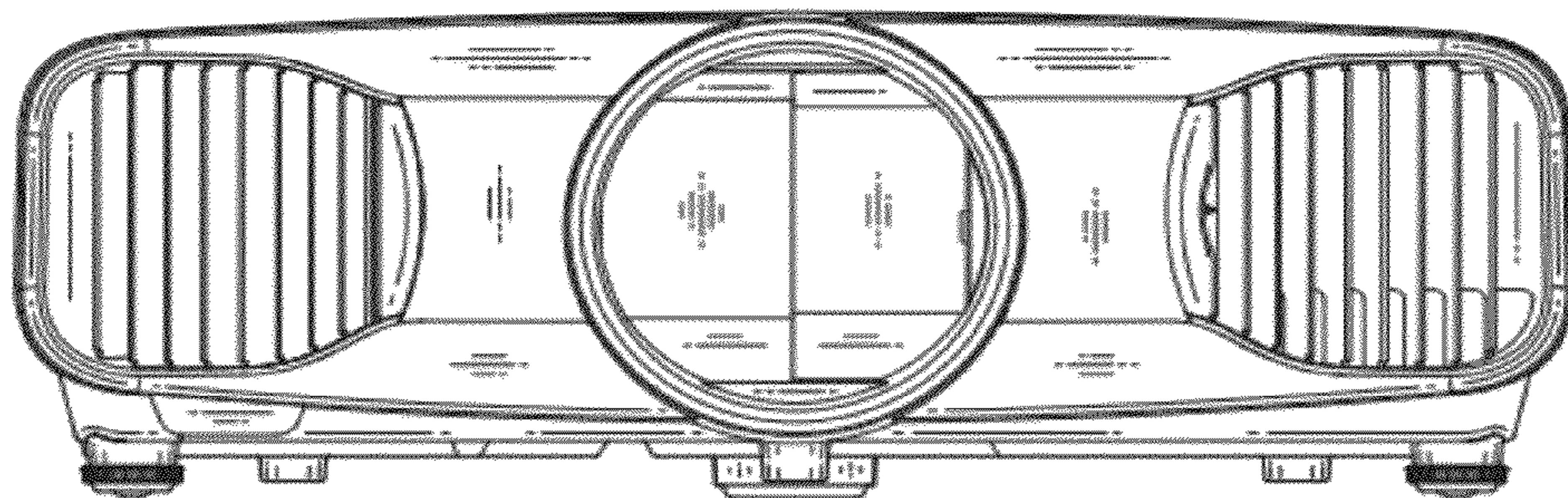

FIG. 12