

US00D661279S

(12) **United States Design Patent**  
**Youn**

(10) **Patent No.:** **US D661,279 S**  
(45) **Date of Patent:** **\*\* Jun. 5, 2012**

(54) **ELECTRONIC DEVICE**

(75) Inventor: **Ji-Hye Youn**, Sunnam-si (KR)

(73) Assignee: **Samsung Electronics Co., Ltd.**,  
Gyeonggi-do (KR)

(\*\*) Term: **14 Years**

(21) Appl. No.: **29/410,296**

(22) Filed: **Jan. 6, 2012**

(51) **LOC (9) Cl.** ..... **14-03**

(52) **U.S. Cl.** ..... **D14/138 AA**

(58) **Field of Classification Search** ..... D14/138 AA,  
D14/138 R, 138 C, 496, 346, 203.1, 203.4,  
D14/203.7, 147, 148, 218, 426; D21/517;  
455/575.1, 556.2; 379/433.01, 433.04; D13/168  
See application file for complete search history.

(56) **References Cited**

**U.S. PATENT DOCUMENTS**

D556,171 S *	11/2007	Lee et al.	.....	D14/138 AA
D562,314 S *	2/2008	Han et al.	.....	D14/248
D573,967 S *	7/2008	Tsai et al.	.....	D14/138 AA
D574,800 S *	8/2008	Stillerman	.....	D14/138 AA
D576,585 S *	9/2008	Stillerman	.....	D14/138 AA
D576,993 S *	9/2008	Park et al.	.....	D14/138 AA
D583,352 S *	12/2008	Son et al.	.....	D14/138 AA
D589,922 S *	4/2009	Boyd et al.	.....	D14/138 AA
D594,834 S *	6/2009	Su et al.	.....	D14/138 AA
D609,208 S *	2/2010	Cheng	.....	D14/138 AA
D609,678 S *	2/2010	Ham	.....	D14/138 AA
D610,109 S *	2/2010	Kim et al.	.....	D14/138 AA
D616,879 S *	6/2010	Kim et al.	.....	D14/250
D617,299 S *	6/2010	Tzeng et al.	.....	D14/138 AA
D632,272 S *	2/2011	Zuffo et al.	.....	D14/138 AA
D639,259 S *	6/2011	Anderson	.....	D14/138 AA
D639,264 S *	6/2011	Tsai	.....	D14/138 AA
D639,265 S *	6/2011	Kao	.....	D14/138 AA
D640,226 S *	6/2011	Park et al.	.....	D14/138 AA
D641,335 S *	7/2011	Lee et al.	.....	D14/138 AA

D645,837 S *	9/2011	Park et al.	.....	D14/138 AA
D648,311 S *	11/2011	Choi et al.	.....	D14/138 AA
D652,010 S *	1/2012	Chung	.....	D14/138 AA

**OTHER PUBLICATIONS**

Samsung E1230 telephone, announced Aug. 2011, [online], [site visited Mar. 23, 2012]. Available from Internet, <URL: <http://www.gsmarena.com>>.\*

Samsung E1232B telephone, announced Aug. 2011, [online], [site visited Mar. 23, 2012]. Available from Internet, <URL: <http://www.gsmarena.com>>.\*

LG GS155 telephone, announced Mar. 2010, [online], [site visited Mar. 23, 2012]. Available from Internet, <URL: <http://www.gsmarena.com>>.\*

Micromax X215 telephone, announced Dec. 2009, [online], [site visited Mar. 23, 2012]. Available from Internet, <URL: <http://www.gsmarena.com>>.\*

Spice M-4250 telephone, announced 2010, [online], [site visited Mar. 23, 2012]. Available from Internet, <URL: <http://www.gsmarena.com>>.\*

\* cited by examiner

*Primary Examiner* — Jeffrey D Asch

(74) *Attorney, Agent, or Firm* — Harness, Dickey & Pierce, P.L.C.

(57) **CLAIM**

I claim the ornamental design for an electronic device, as shown.

**DESCRIPTION**

FIG. 1 is a front/right-side/top perspective view of an electronic device showing our new design;  
FIG. 2 is a front-side elevational view thereof;  
FIG. 3 is a rear-side elevational view thereof;  
FIG. 4 is a left-side elevational view thereof;  
FIG. 5 is a right-side elevational view thereof;  
FIG. 6 is a top-side elevational view thereof; and,  
FIG. 7 is a bottom-side elevational view thereof.

**1 Claim, 6 Drawing Sheets**

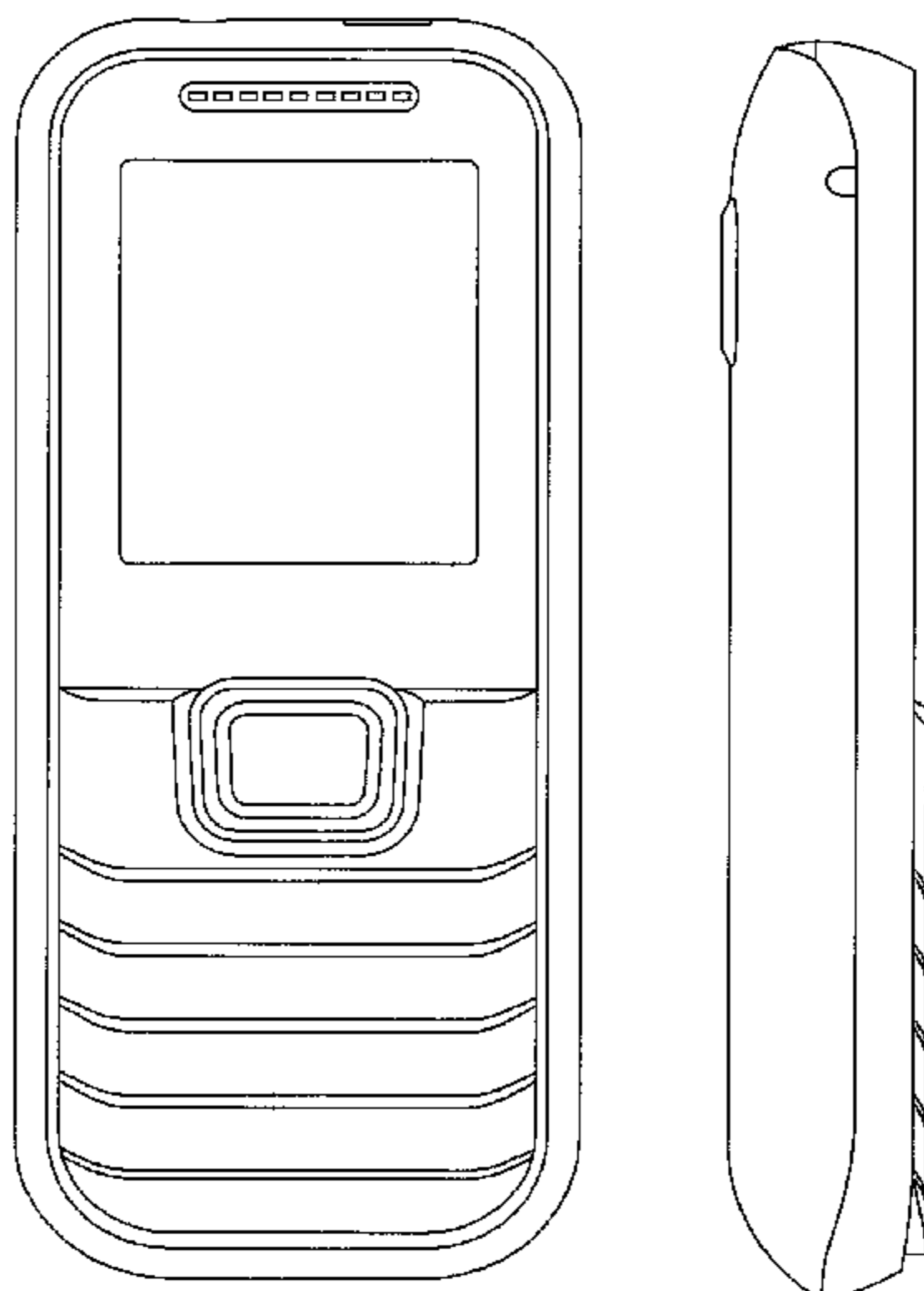

FIG. 1

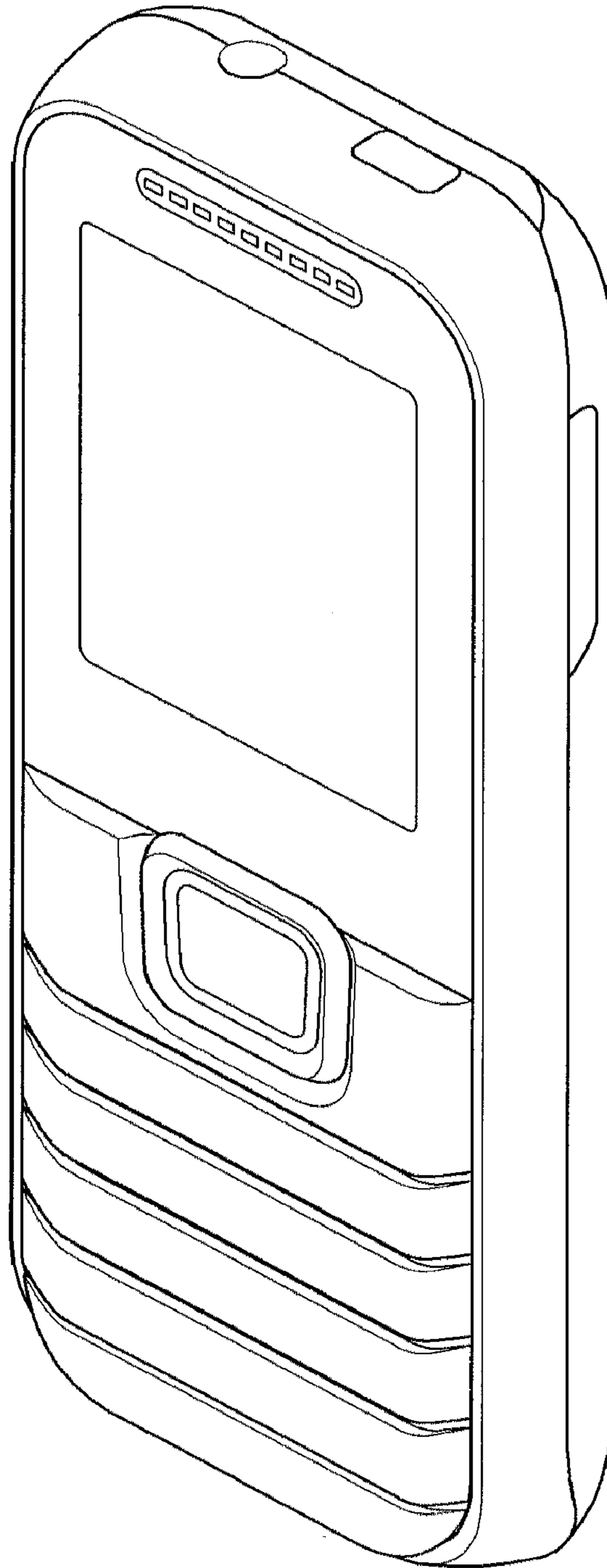

FIG. 2

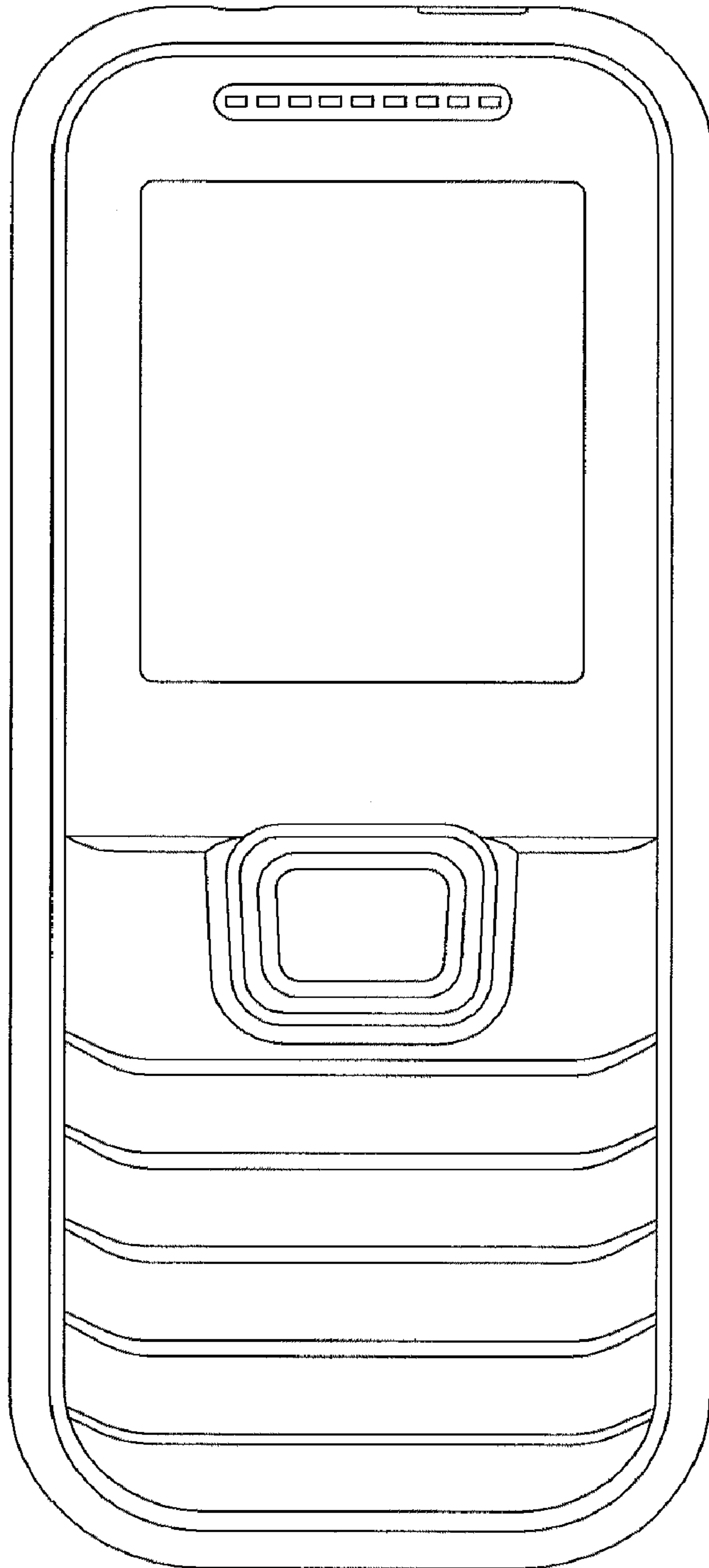

FIG. 3

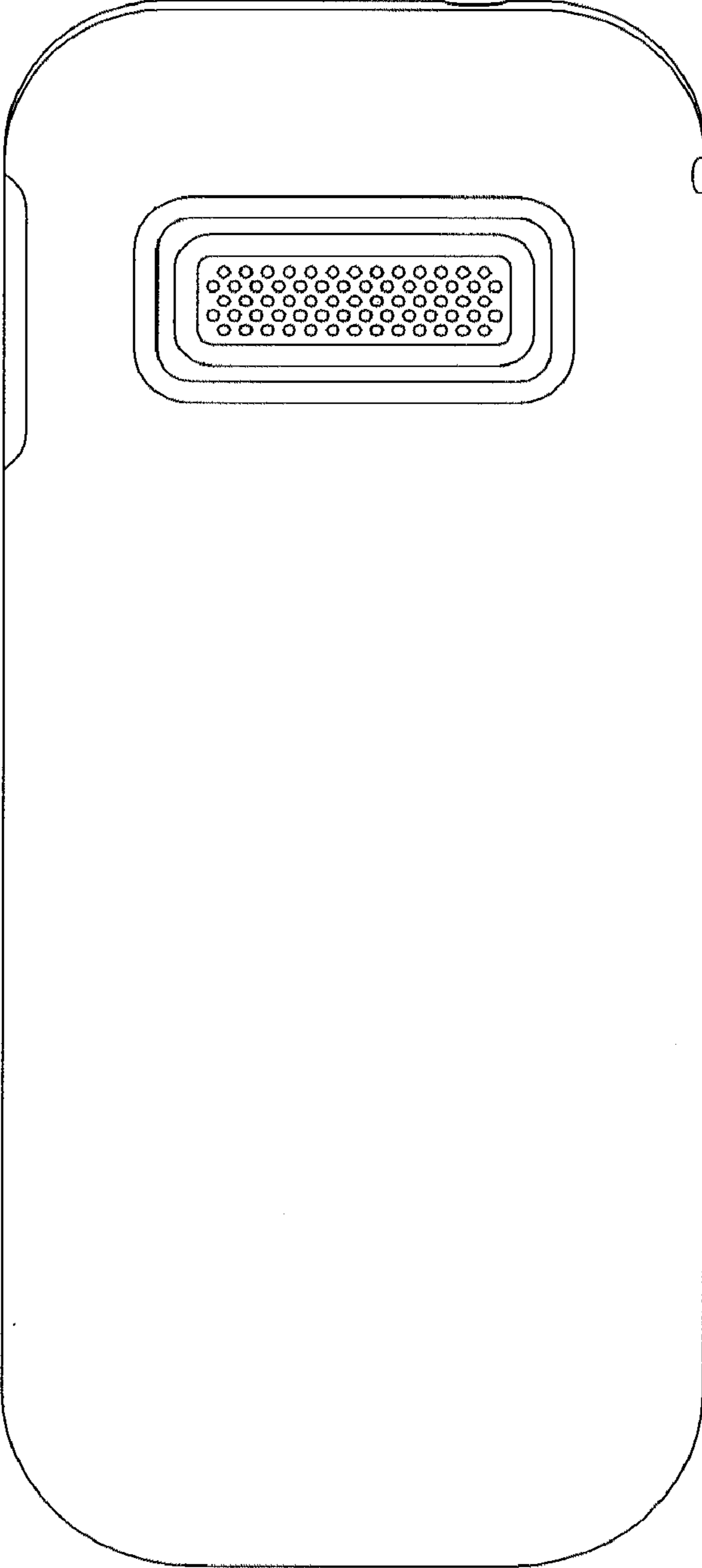

FIG. 4

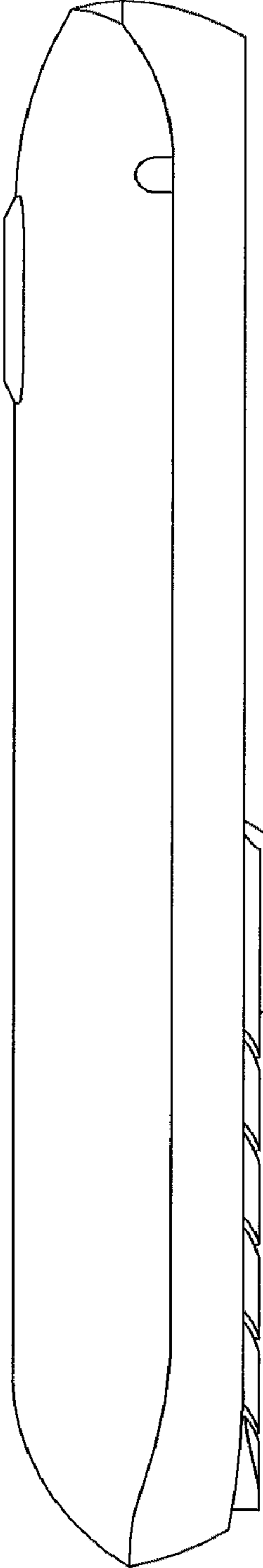
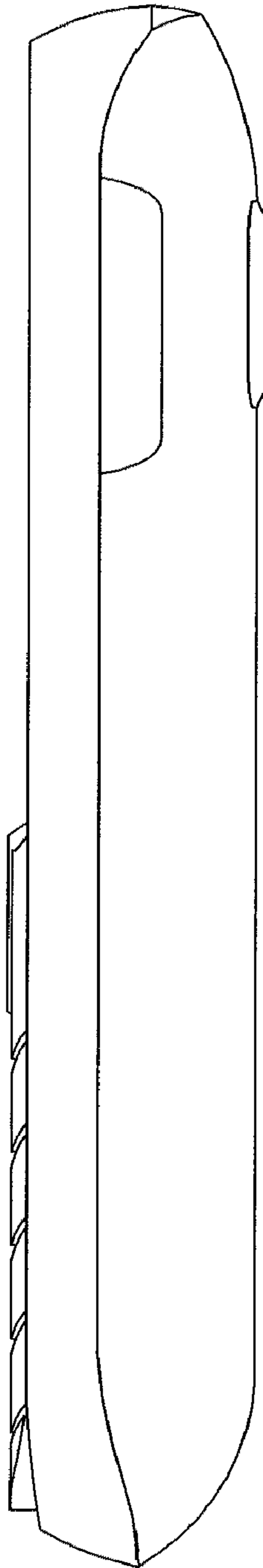
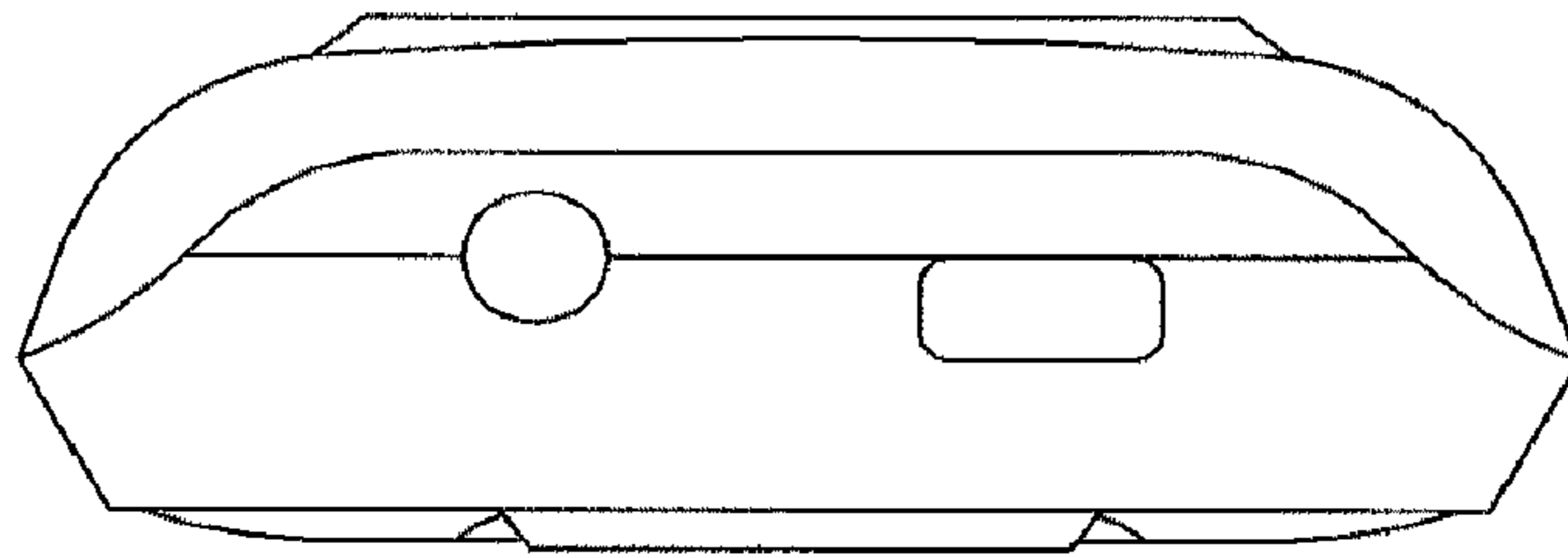

FIG. 5



**FIG. 6**



**FIG. 7**

