



US00D661255S

(12) **United States Design Patent**  
**Kane**

(10) **Patent No.:** **US D661,255 S**  
(45) **Date of Patent:** **\*\* \*Jun. 5, 2012**

(54) **CONDITIONING EQUIPMENT HOUSING**

(75) Inventor: **Michael T. Kane**, Fairport, NY (US)

(73) Assignee: **John Mezzalingua Associates, Inc.**,  
East Syracuse, NY (US)

(\*) Notice: This patent is subject to a terminal disclaimer.

(\*\*) Term: **14 Years**

(21) Appl. No.: **29/345,274**

(22) Filed: **Oct. 13, 2009**

**Related U.S. Application Data**

(63) Continuation of application No. 12/546,101, filed on Aug. 24, 2009.

(51) **LOC (9) Cl.** ..... **13-03**

(52) **U.S. Cl.** ..... **D13/151**

(58) **Field of Classification Search** ..... D13/133,  
D13/146, 147, 151, 154, 158, 184, 199; D14/125,  
D14/217, 230, 239, 299; 174/59; 333/100,  
333/101, 206; 439/63, 579, 578, 581, 709  
See application file for complete search history.

(56) **References Cited**

**U.S. PATENT DOCUMENTS**

3,353,144	A	11/1967	Brookman	
3,976,352	A	8/1976	Spinner	
4,063,110	A	12/1977	Glick	
4,805,073	A	2/1989	Johnson et al.	
5,185,500	A	2/1993	Spinner	
5,434,368	A	7/1995	Hoffmann	
5,488,208	A	1/1996	Seewald	
D408,363	S *	4/1999	Hsiang	D13/151
5,899,769	A	5/1999	Konetschny et al.	
5,960,140	A	9/1999	Caplan et al.	
D452,682	S *	1/2002	Inoue	D13/151

6,431,911	B2	8/2002	Pitschi	
6,716,061	B2	4/2004	Pitschi et al.	
D491,149	S *	6/2004	Hoshino	D13/151
6,963,037	B1	11/2005	Bennett et al.	
6,976,872	B1	12/2005	Wild et al.	
6,979,775	B2	12/2005	Ritter et al.	
7,008,264	B2	3/2006	Wild	
D521,939	S *	5/2006	Mahoney	D13/151
7,140,889	B1	11/2006	Shah et al.	
7,147,494	B2	12/2006	Lindner	
7,156,674	B1	1/2007	Frank	
7,163,410	B2	1/2007	Isaacks	
D551,172	S *	9/2007	Hoshino	D13/151
7,284,995	B1	10/2007	Vail	
7,357,671	B2	4/2008	Wild et al.	
7,374,455	B2	5/2008	Purdy et al.	
7,410,373	B2	8/2008	Isaacks	
D607,413	S *	1/2010	Egan et al.	D13/151
D607,414	S *	1/2010	Egan et al.	D13/151
D623,598	S *	9/2010	Kondo	D13/151
2007/0149047	A1	6/2007	Wild et al.	
2008/0139047	A1	6/2008	Montena	

\* cited by examiner

*Primary Examiner* — Thomas Johannes

(57) **CLAIM**

The ornamental design for a conditioning equipment housing, as shown and described.

**DESCRIPTION**

FIG. 1 is a top, front perspective view of a conditioning equipment housing showing my new design; FIG. 2 is a front elevation view thereof; FIG. 3 is a rear elevation view thereof; FIG. 4 is a left elevation view thereof; FIG. 5 is a right elevation view thereof; FIG. 6 is a top plan view thereof; and, FIG. 7 is a bottom plan view thereof. Broken lines are shown herein depict unclaimed subject matter only, and form no part of the claimed design.

**1 Claim, 5 Drawing Sheets**

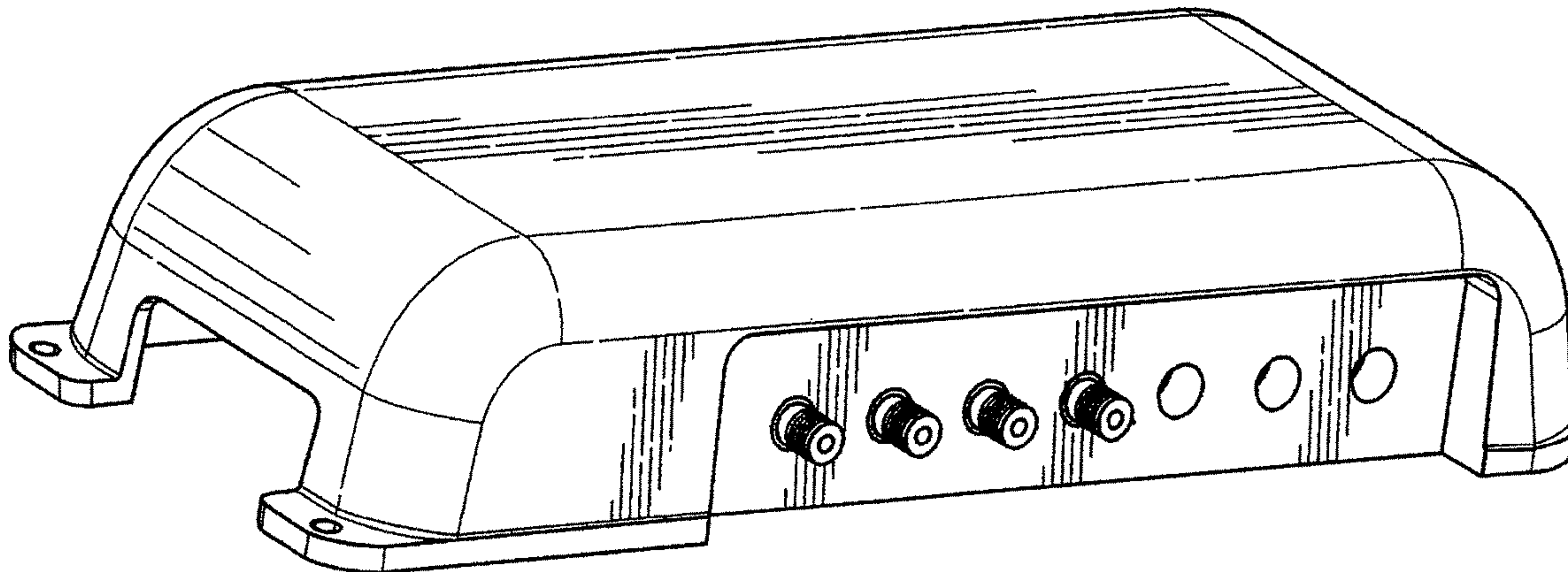

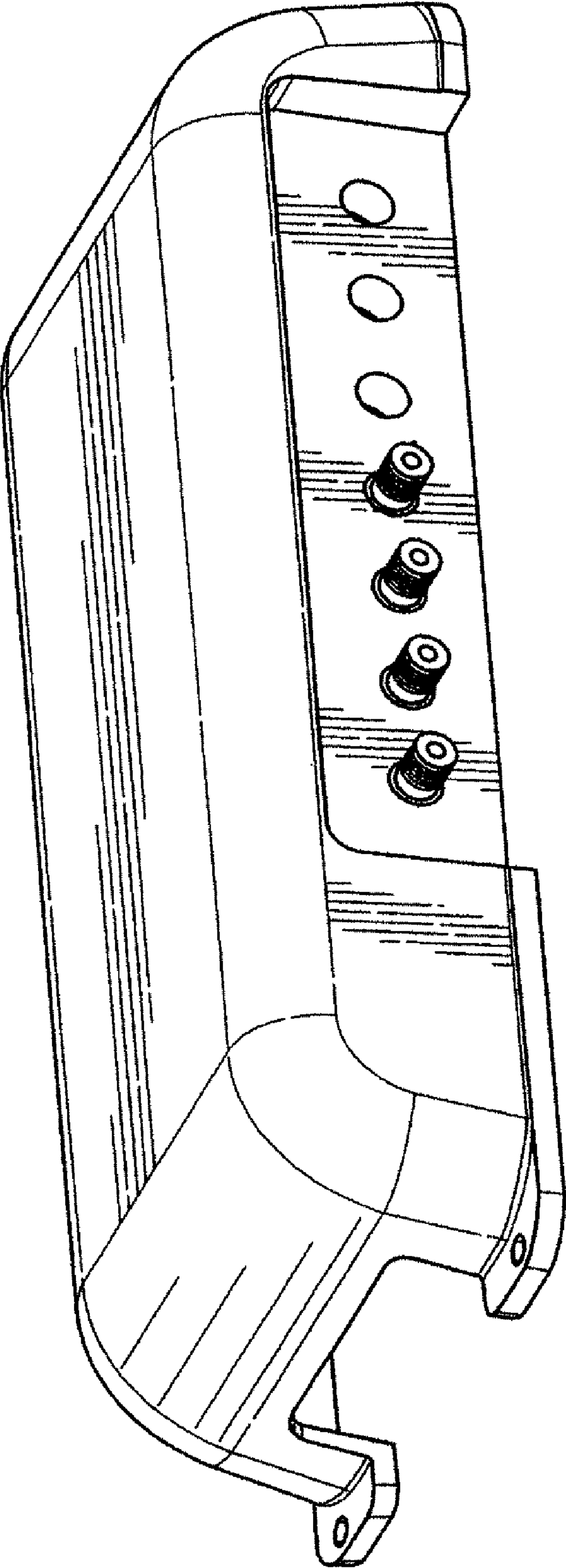

FIG. 1

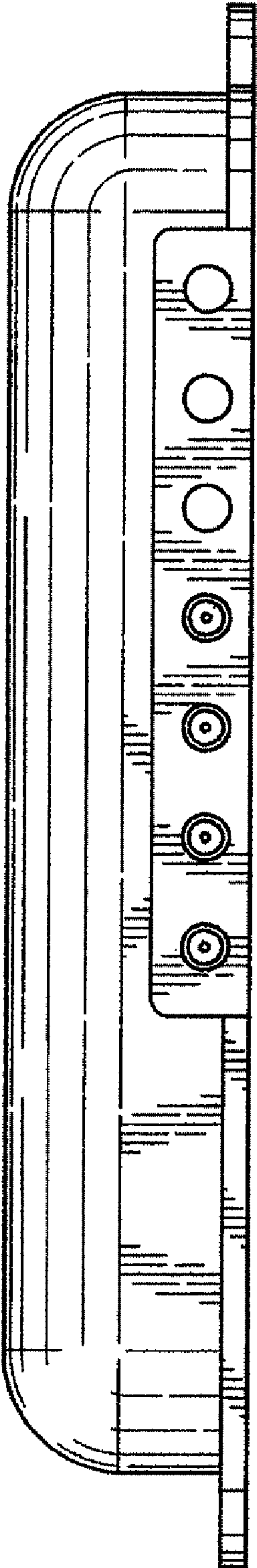

FIG. 2

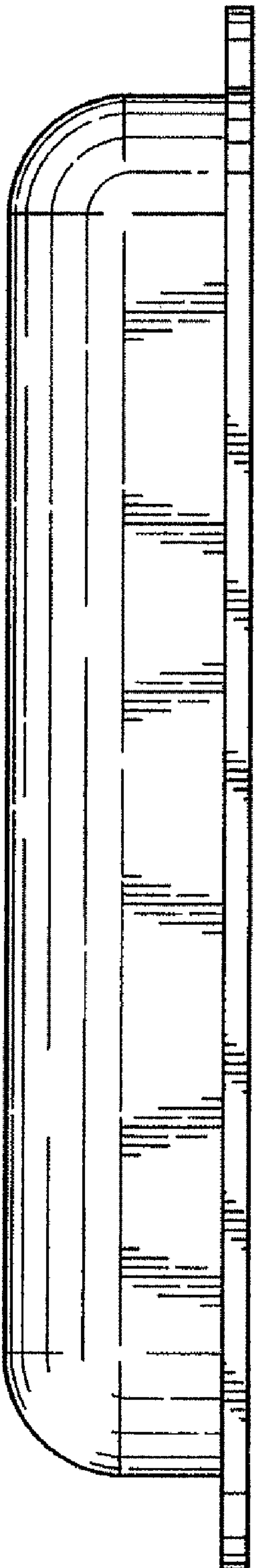

FIG. 3

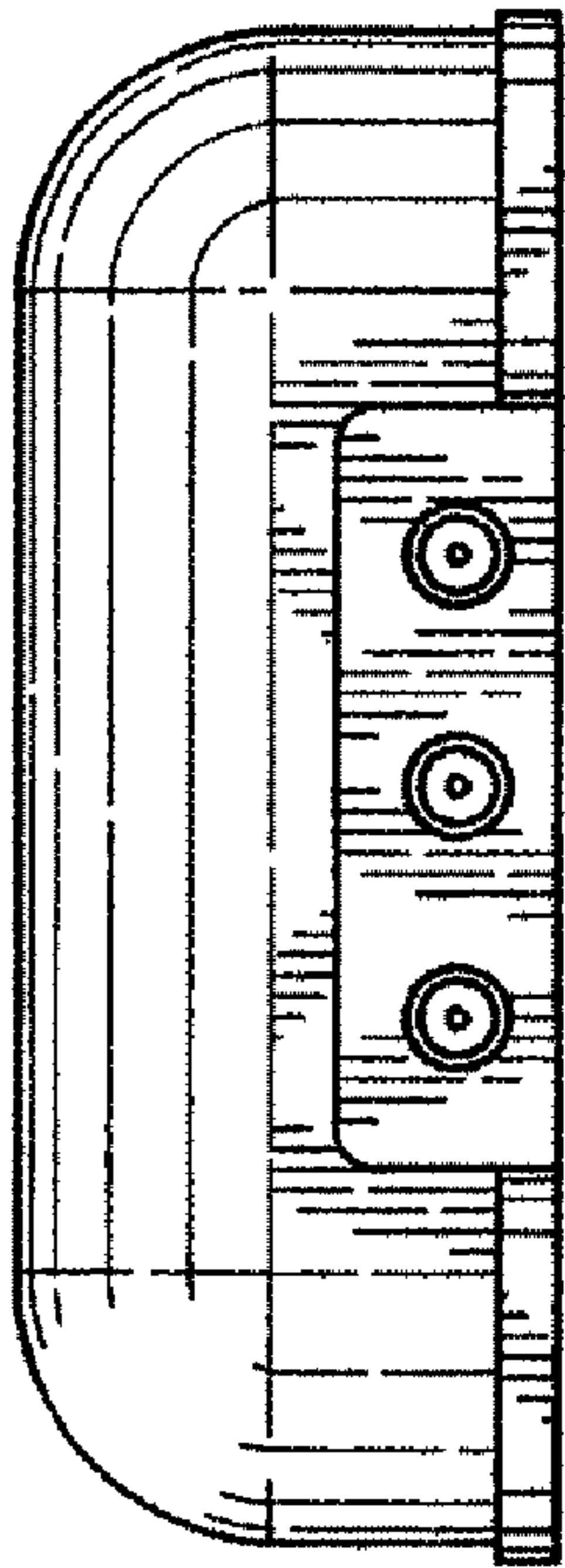

FIG. 4

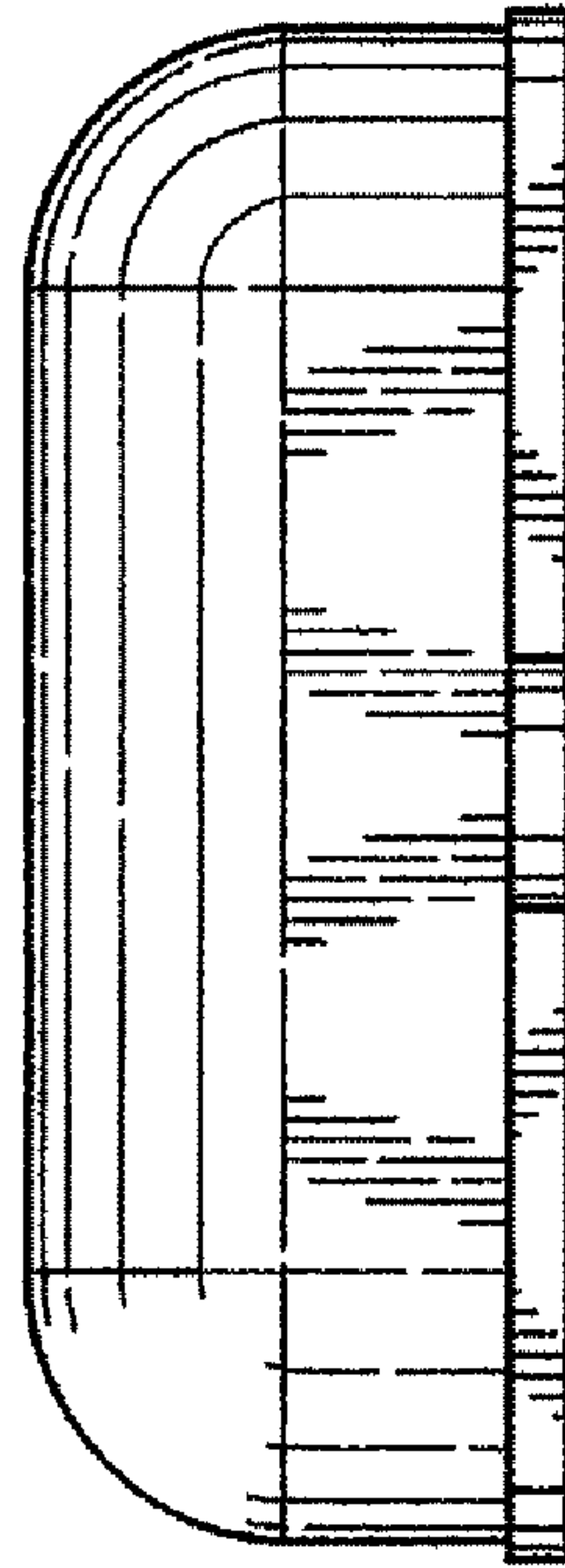

FIG. 5



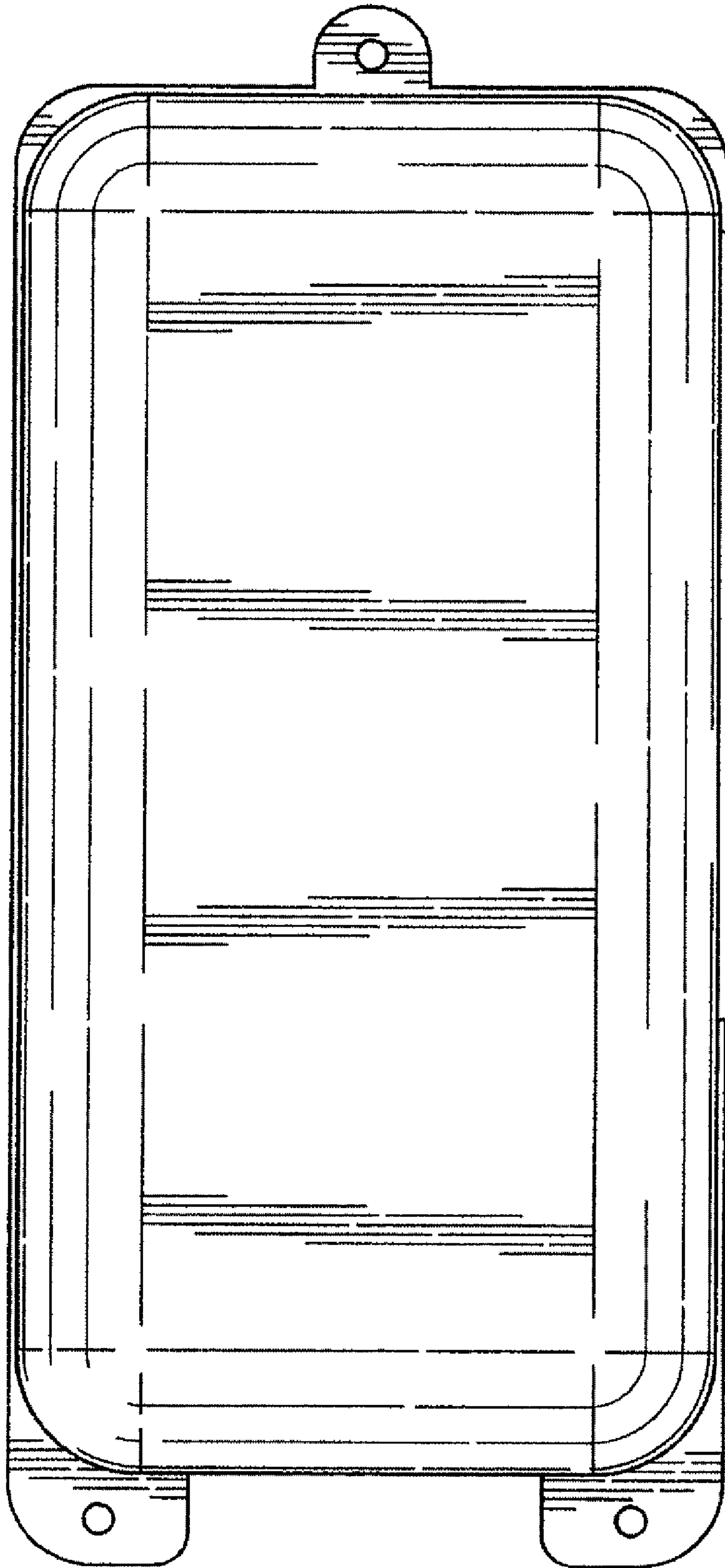

FIG. 6

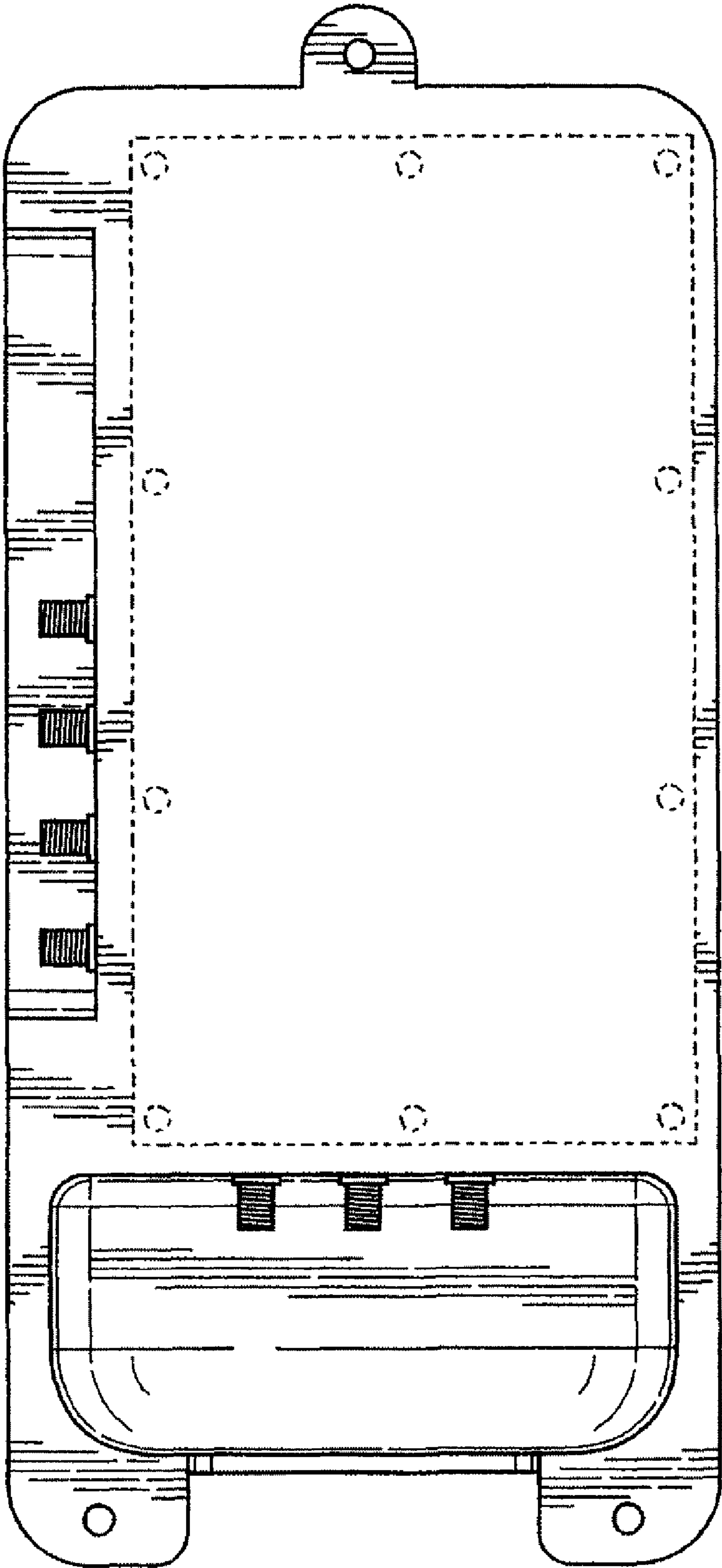

FIG. 7