



US00D661219S

(12) **United States Design Patent**  
**Papadimitriou**

(10) **Patent No.:** **US D661,219 S**  
(45) **Date of Patent:** **\*\* Jun. 5, 2012**

(54) **EARRING**

(75) Inventor: **Costantino Papadimitriou**, Milan (IT)

(73) Assignee: **De Beers Centenary AG**, Lucerne (CH)

(\*\*) Term: **14 Years**

(21) Appl. No.: **29/400,855**

(22) Filed: **Sep. 1, 2011**

(30) **Foreign Application Priority Data**

Mar. 4, 2011 (EM) ..... 001831181  
Mar. 4, 2011 (EM) ..... 001831280

(51) **LOC (9) Cl.** ..... **11-01**

(52) **U.S. Cl.** ..... **D11/43; D11/79**

(58) **Field of Classification Search** ..... D11/79-85,  
D11/89-91, 40-48, 1-8; 63/26-28, 12-14,  
63/3, 3.1, 3.2

See application file for complete search history.

(56) **References Cited**

**U.S. PATENT DOCUMENTS**

D19,102 S \* 5/1889 Stayner ..... D11/79  
(Continued)

*Primary Examiner* — Cathron Brooks

*Assistant Examiner* — Melanie Pellegrini

(74) *Attorney, Agent, or Firm* — SNR Denton US LLP;  
Brian R. McGinley

(57) **CLAIM**

The ornamental design for an earring, as shown and described.

**DESCRIPTION**

FIG. 1 is a top view of a first embodiment of the earring;  
FIG. 2 is a bottom view of the earring illustrated in FIG. 1;  
FIG. 3 is a right elevational view of the earring illustrated in FIG. 1;

FIG. 4 is a left elevational view of the earring illustrated in FIG. 1;

FIG. 5 is a front view of the earring illustrated in FIG. 1;

FIG. 6 is a rear view of the earring illustrated in FIG. 1;

FIG. 7 is a perspective view of the earring illustrated in FIG. 1

FIG. 8 is a top view of a second embodiment of the earring;

FIG. 9 is a bottom view of the earring illustrated in FIG. 8;

FIG. 10 is a right elevational view of the earring illustrated in FIG. 8;

FIG. 11 is a left elevational view of the earring illustrated in FIG. 8;

FIG. 12 is a front view of the earring illustrated in FIG. 8;

FIG. 13 is a rear view of the earring illustrated in FIG. 8;

FIG. 14 is a perspective view of the earring illustrated in FIG. 8

FIG. 15 is a top view of a third embodiment of the earring;

FIG. 16 is a bottom view of the earring illustrated in FIG. 15;

FIG. 17 is a right elevational view of the earring illustrated in FIG. 15;

FIG. 18 is a left elevational view of the earring illustrated in FIG. 15;

FIG. 19 is a front view of the earring illustrated in FIG. 15;

FIG. 20 is a rear view of the earring illustrated in FIG. 15;

FIG. 21 is a perspective view of the earring illustrated in FIG. 15;

FIG. 22 is a top view of a fourth embodiment of the earring;

FIG. 23 is a bottom view of the earring illustrated in FIG. 22;

FIG. 24 is a right elevational view of the earring illustrated in FIG. 22;

FIG. 25 is a left elevational view of the earring illustrated in FIG. 22;

FIG. 26 is a front view of the earring illustrated in FIG. 22;

FIG. 27 is a rear view of the earring illustrated in FIG. 22; and,

FIG. 28 is a perspective view of the earring illustrated in FIG. 22.

**1 Claim, 24 Drawing Sheets**

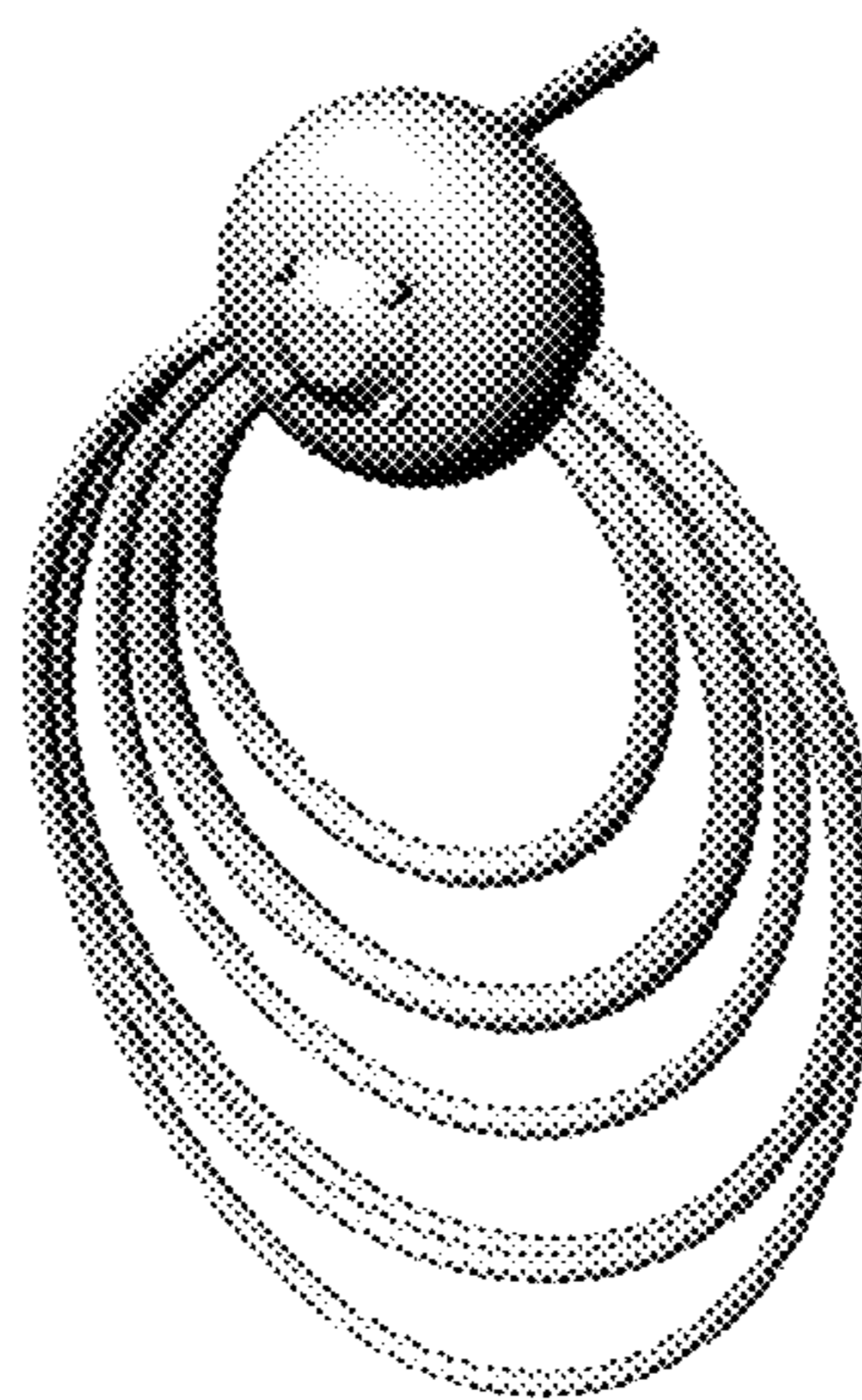
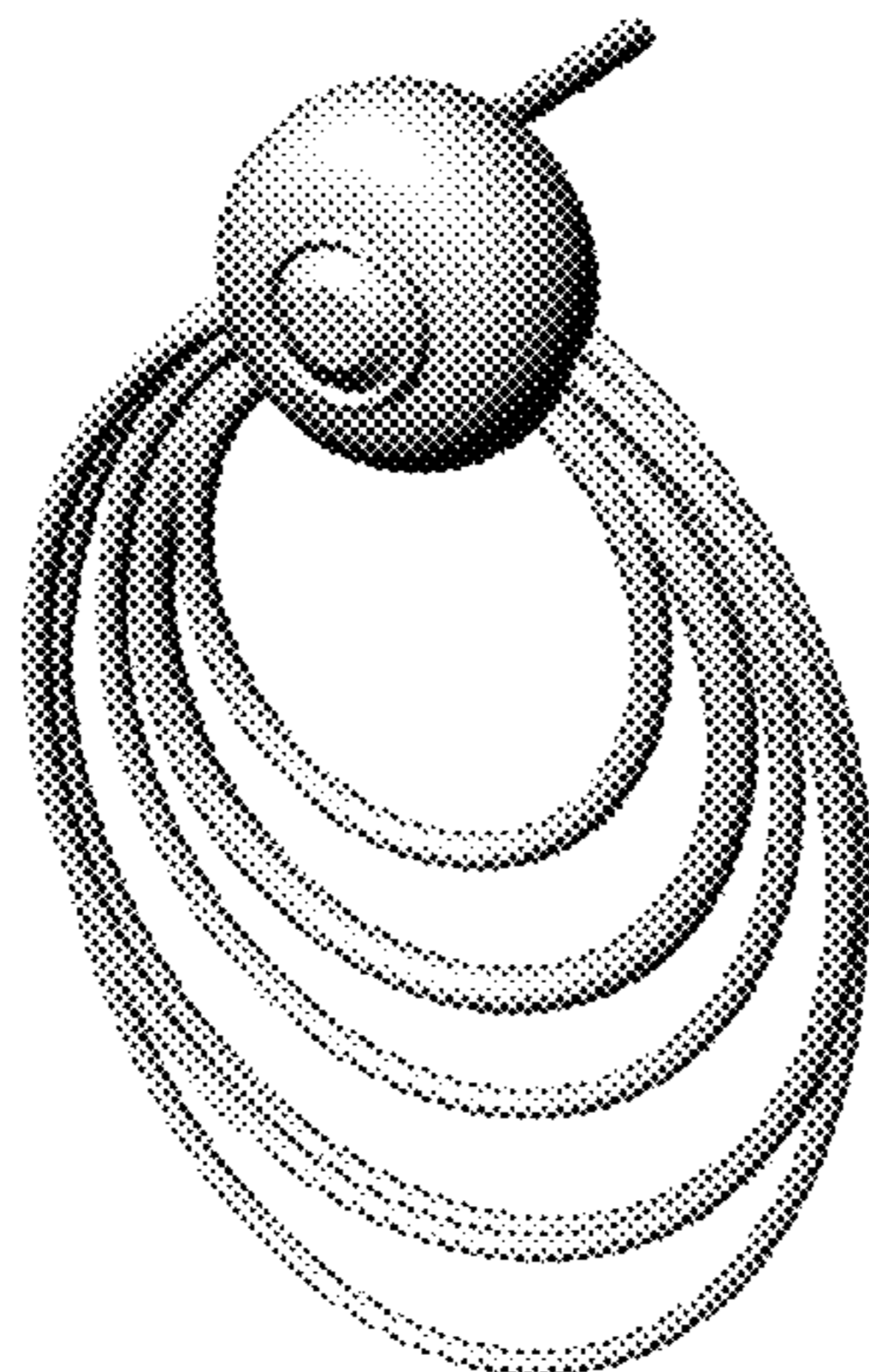

# US D661,219 S

Page 2

## U.S. PATENT DOCUMENTS

D32,246 S	2/1900	Bigney	
D40,581 S	3/1910	Finberg	
1,732,250 A	10/1929	Wehse	
D114,212 S *	4/1939	Graeter	D11/48
D138,956 S *	10/1944	Karples	D11/75
D148,172 S *	12/1947	Katz	D11/75
D164,946 S	10/1951	Philippe	
D248,380 S *	7/1978	Burchett	D11/43
D260,140 S	8/1981	Bicenko	
D308,348 S *	6/1990	Leopoldi	D11/43
D408,316 S	4/1999	Perrin et al.	
D455,097 S *	4/2002	Salvarani	D11/79
6,688,507 B2 *	2/2004	McCormack	24/3.3
D489,024 S	4/2004	Beber et al.	
D497,322 S *	10/2004	Gruosi-Scheufele	D11/79
7,121,117 B2 *	10/2006	Gruosi-Scheufele	63/1.14
D533,479 S	12/2006	Dubnicka	
D542,696 S	5/2007	Cilluffo	
D586,685 S	2/2009	Damiani	
D597,435 S	8/2009	Gruosi	
D625,640 S *	10/2010	Sivriere	D11/1
D636,696 S *	4/2011	Lebail	D11/43
D637,103 S *	5/2011	Lebail	D11/43

\* cited by examiner

FIG. 1

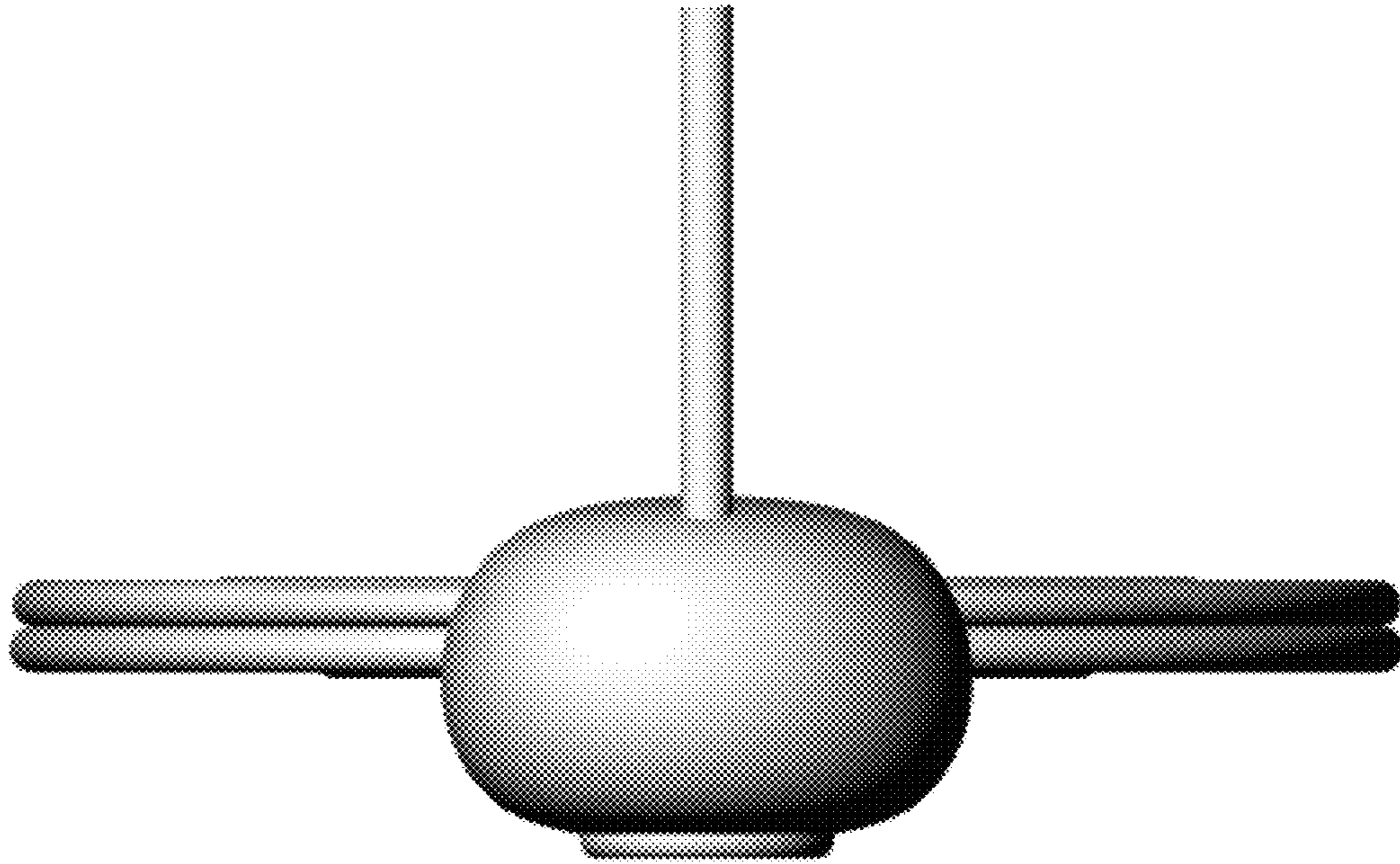

FIG. 2

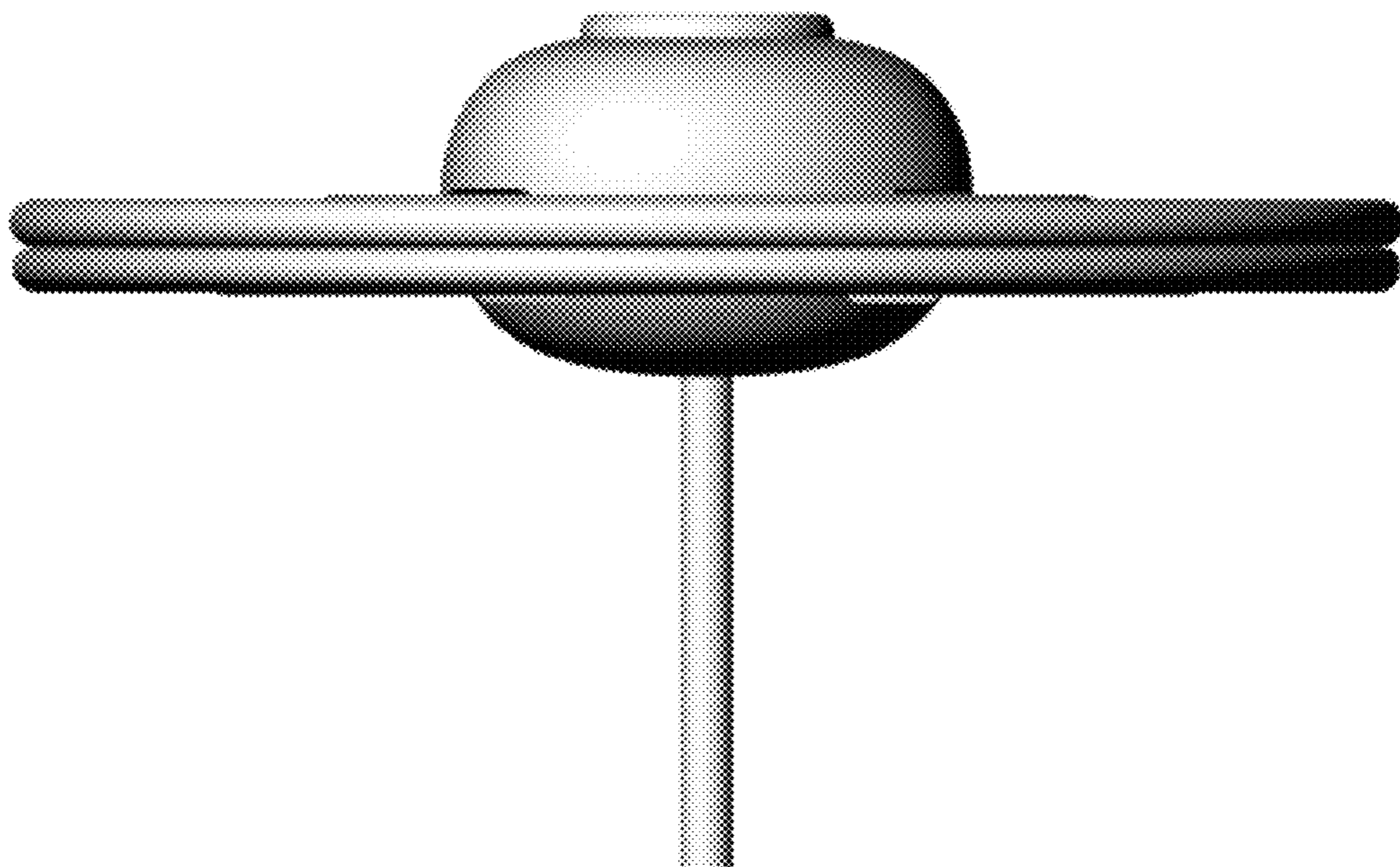

FIG. 3

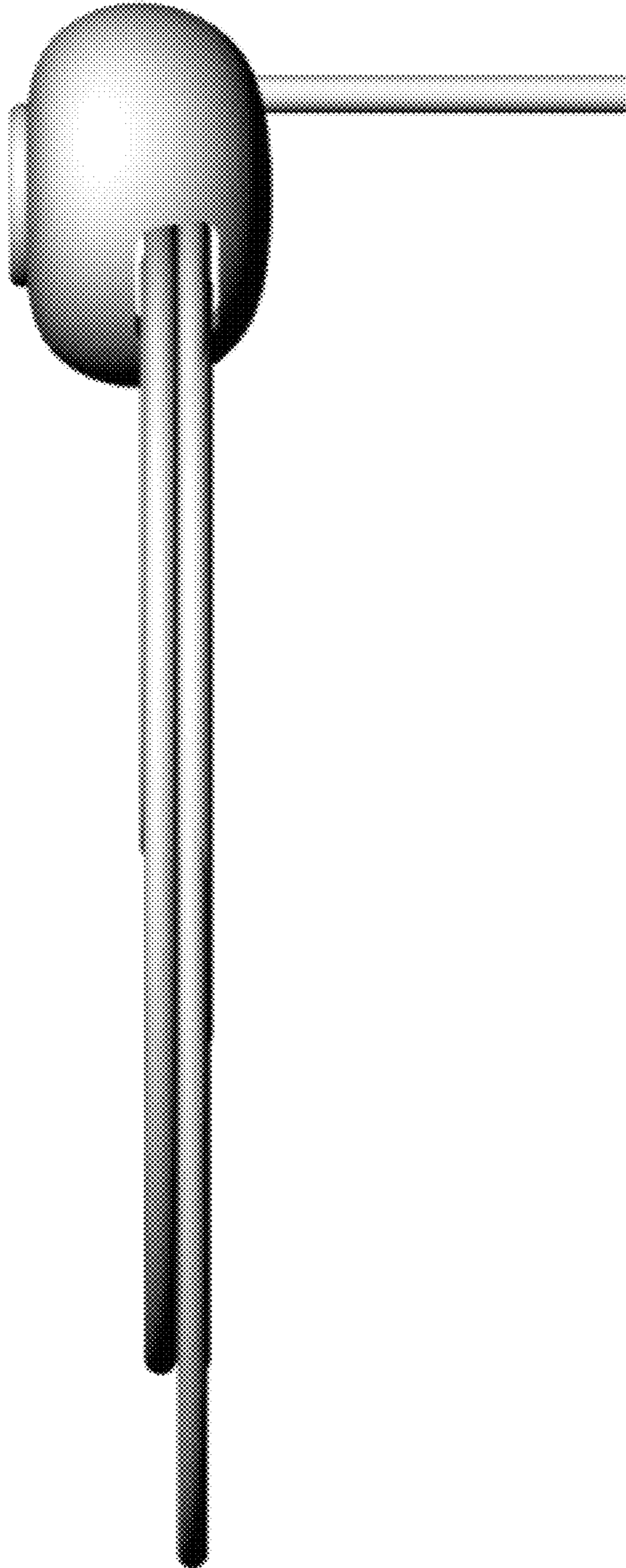

FIG. 4

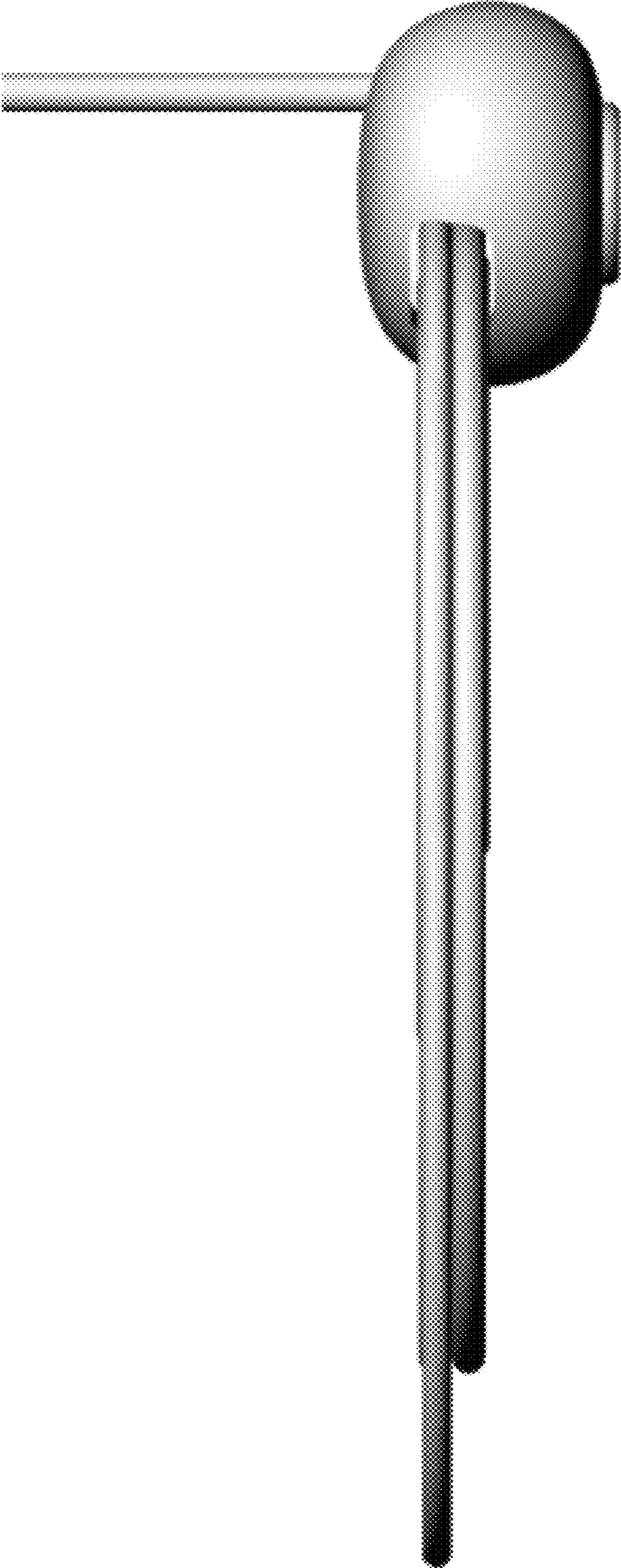

FIG. 5

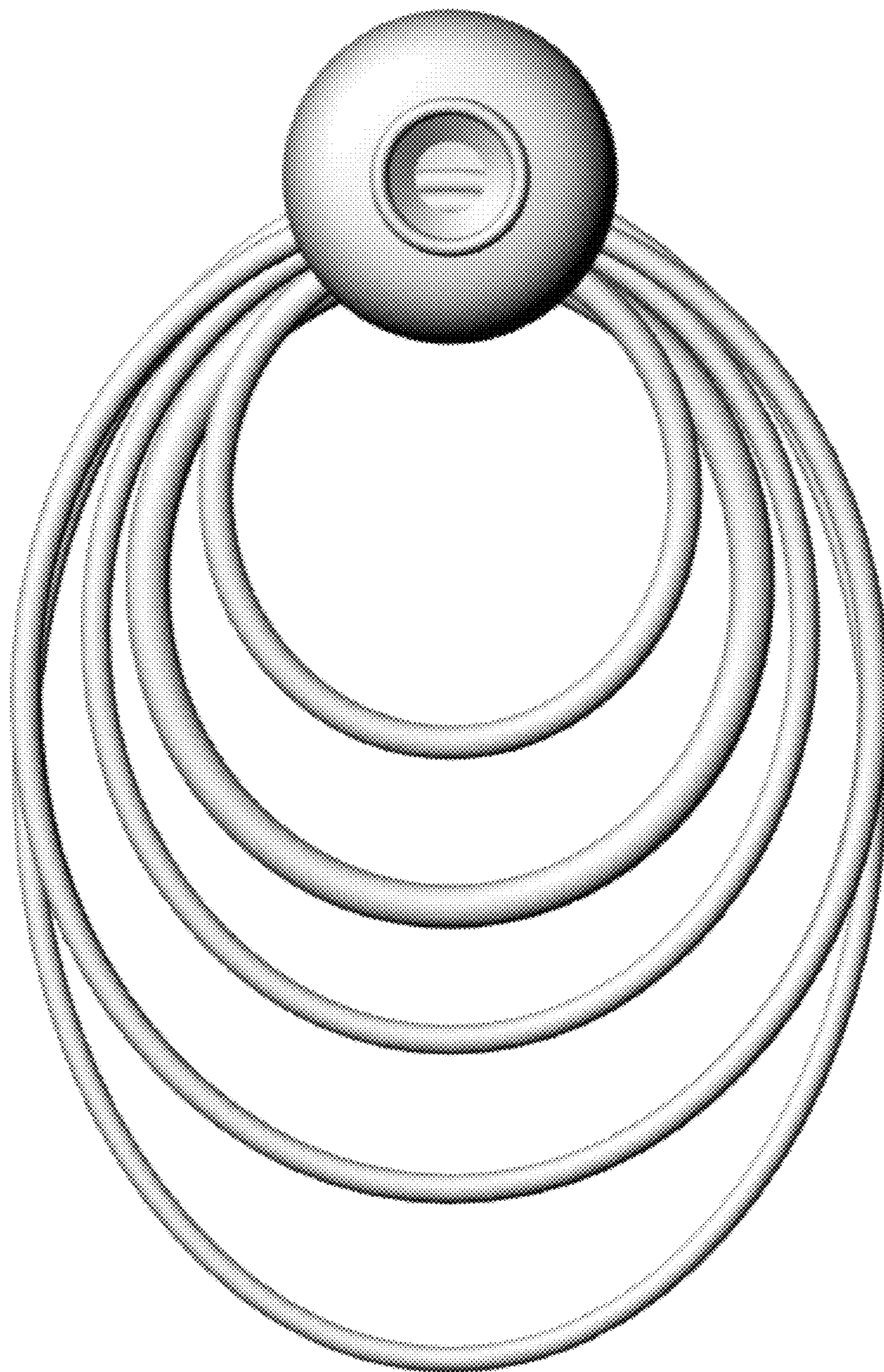

FIG. 6

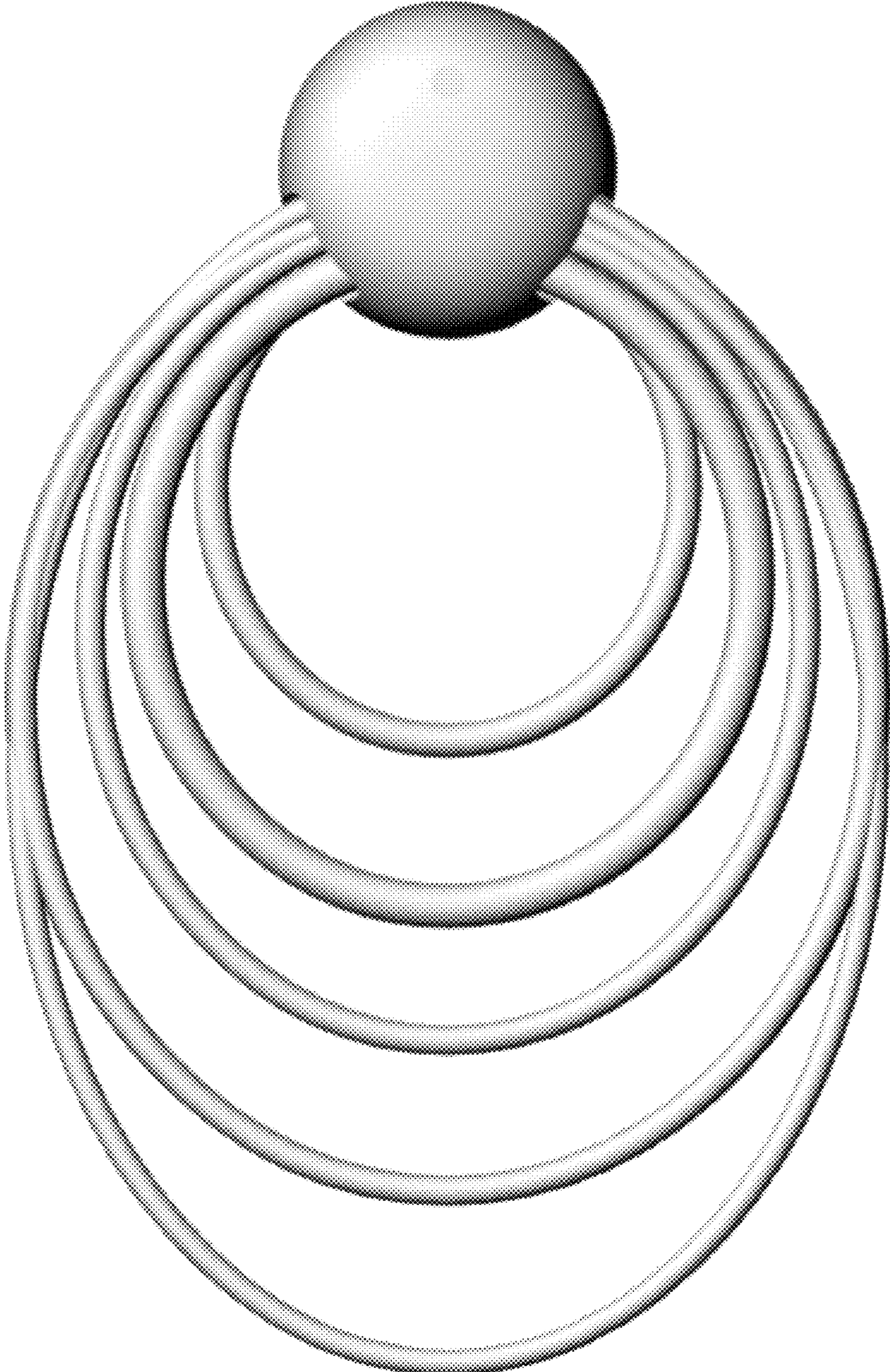

FIG. 7

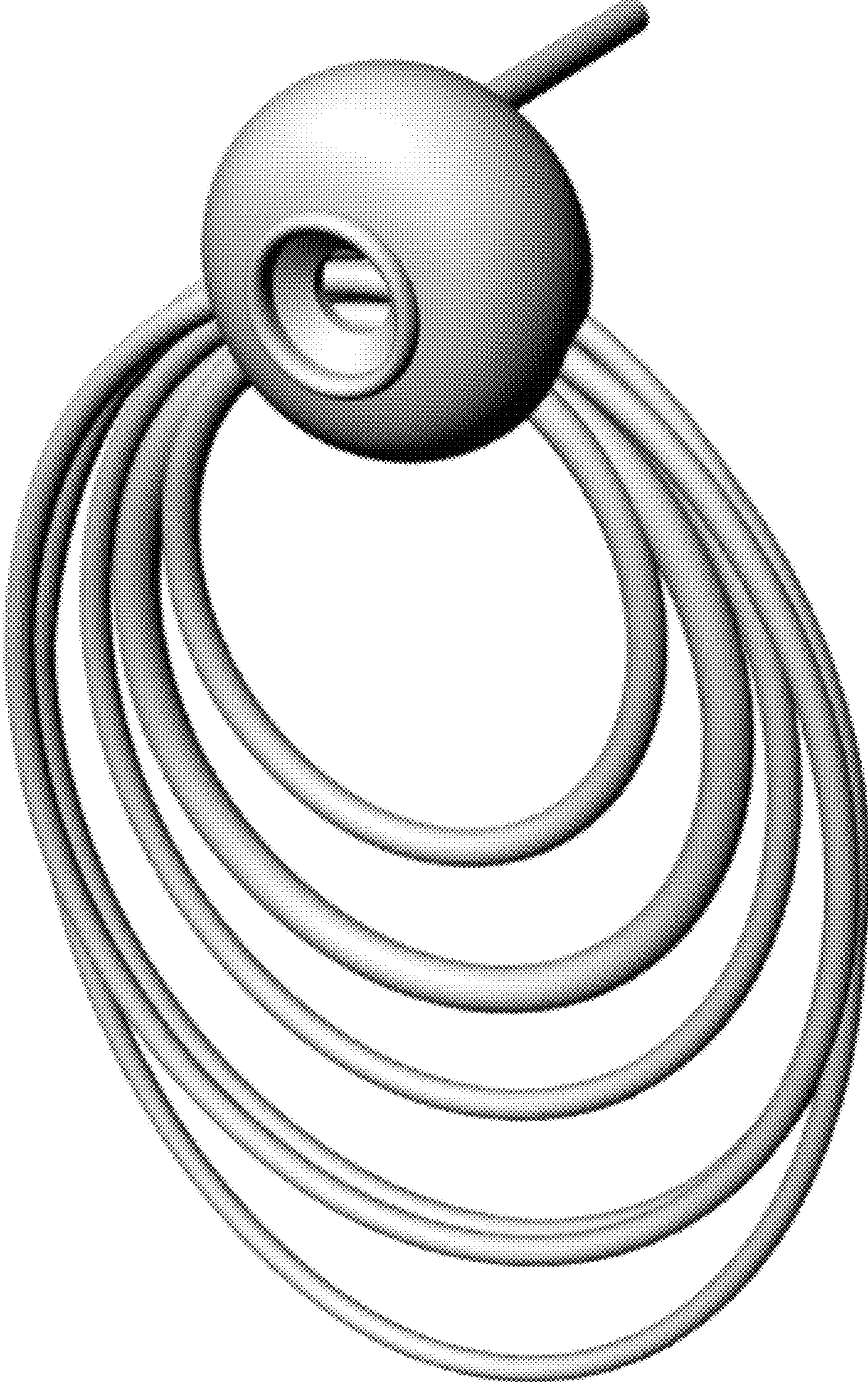



FIG. 8

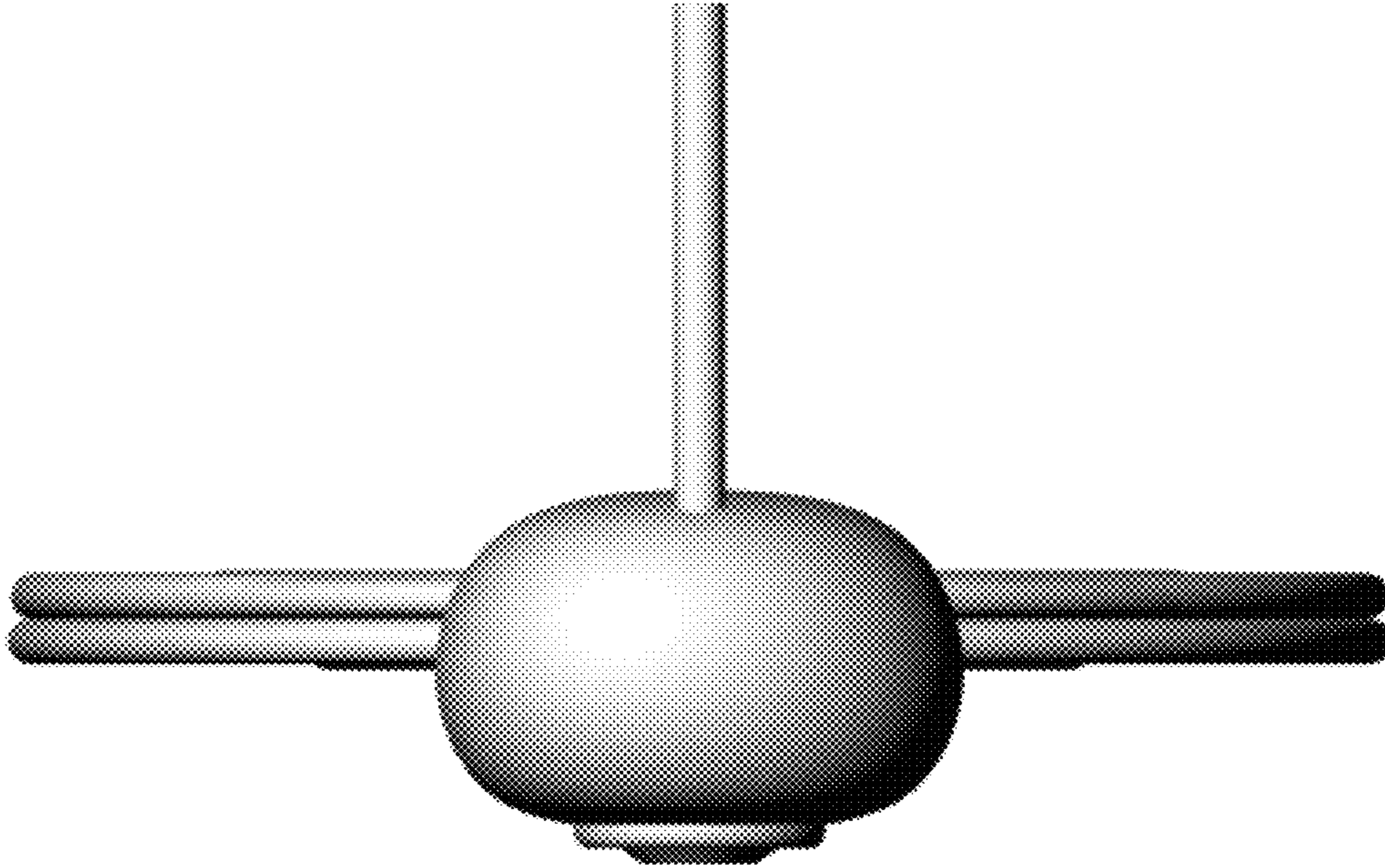

FIG. 9

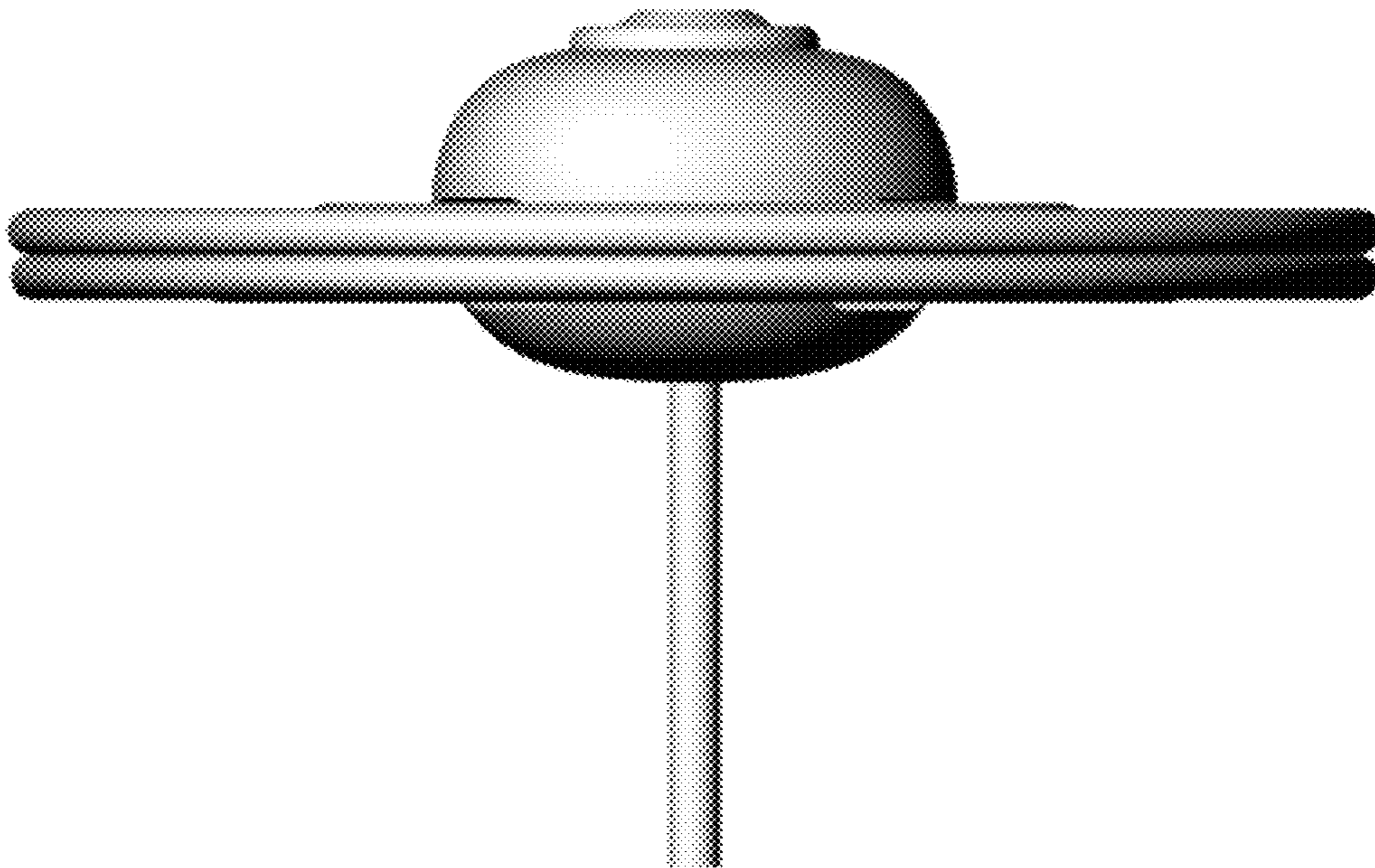

FIG. 10

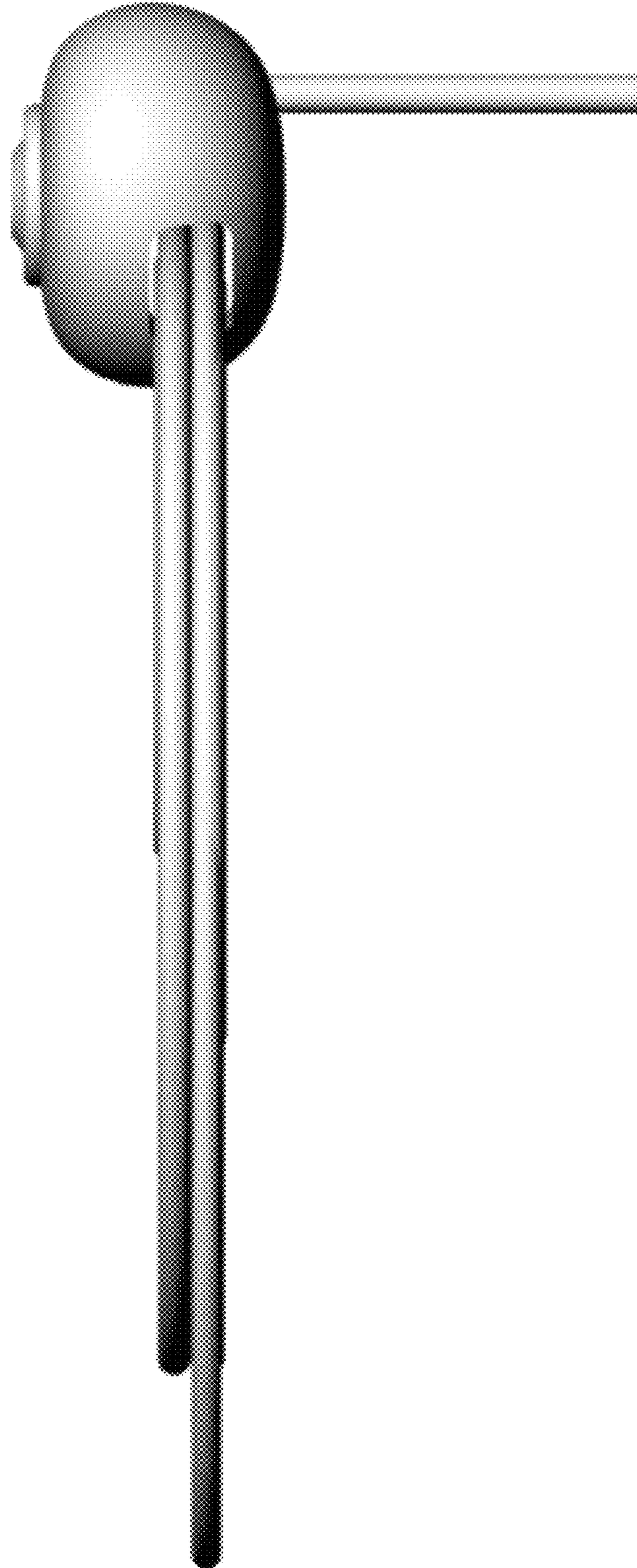

FIG. 11

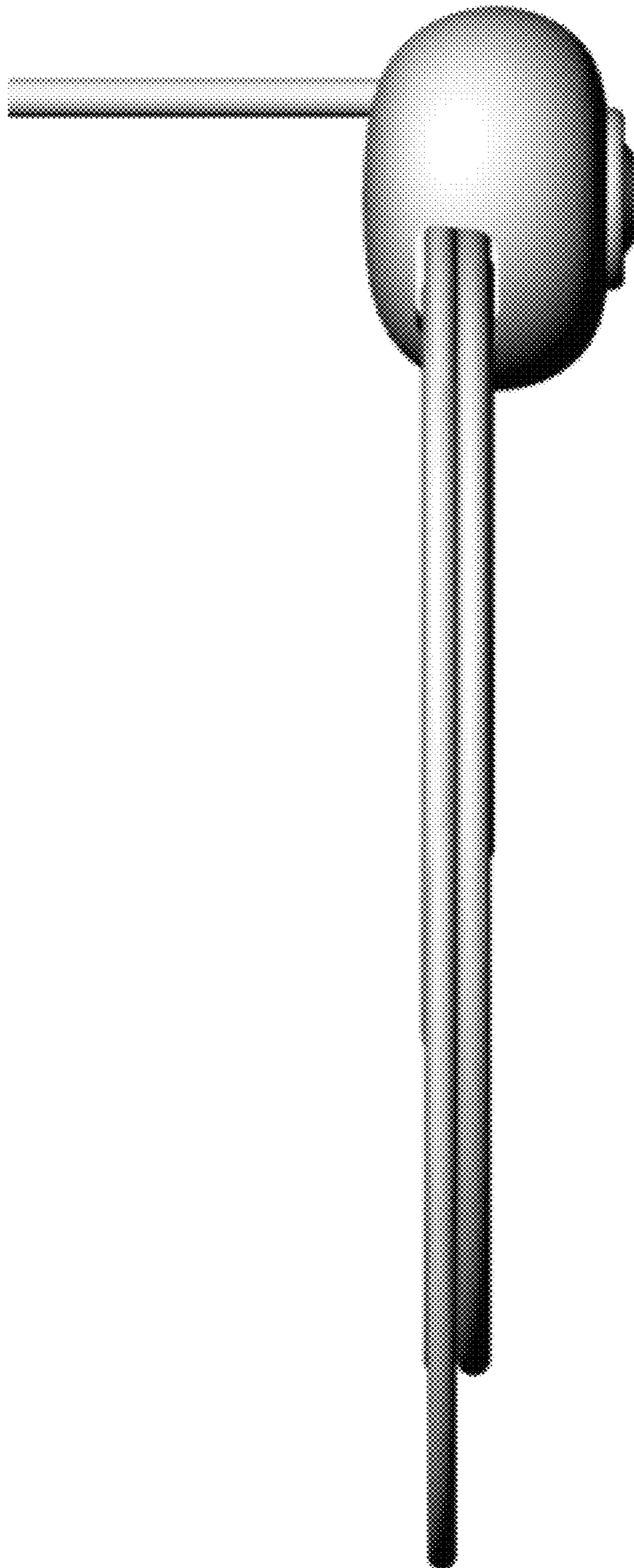

FIG. 12

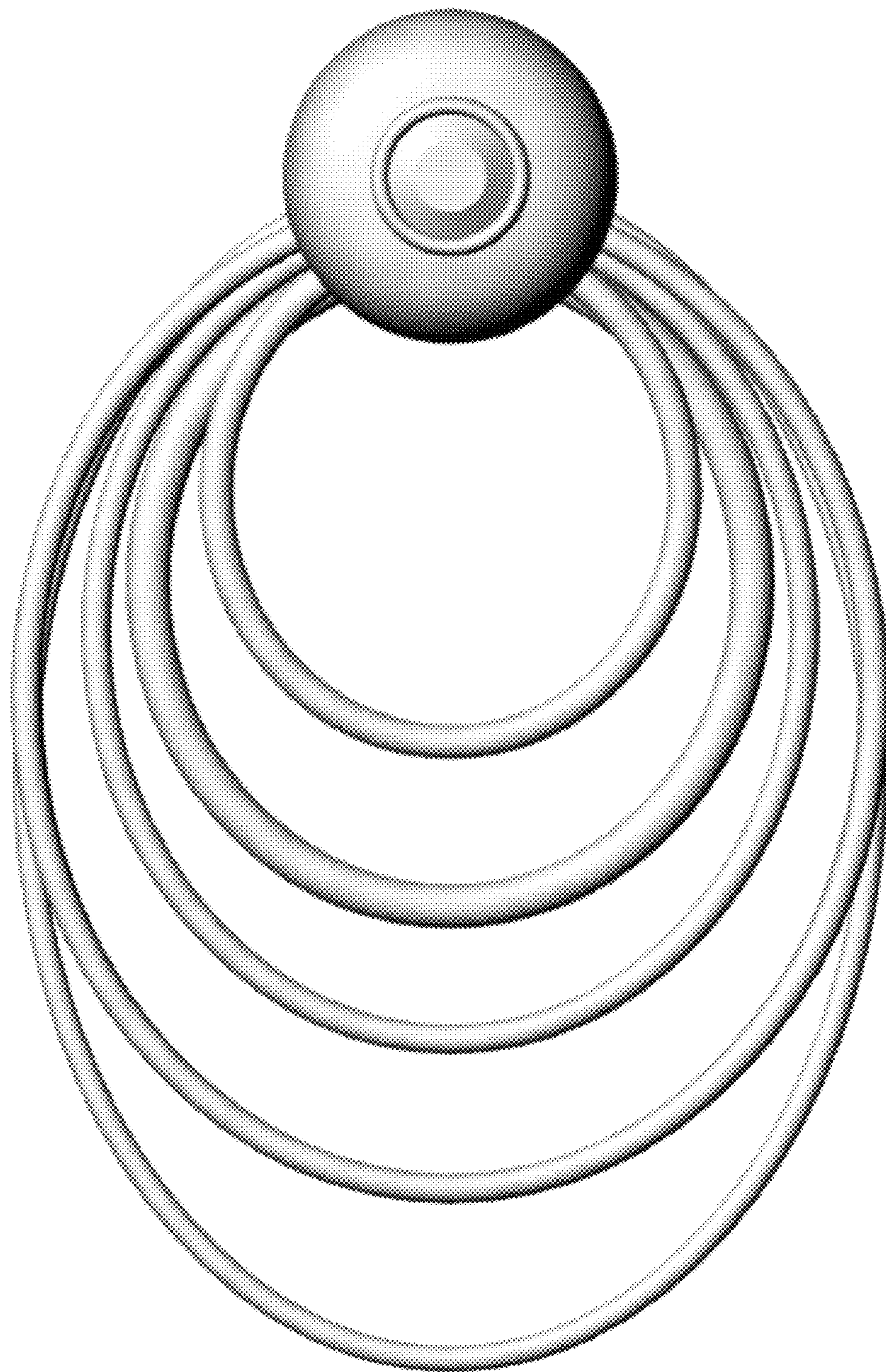

FIG. 13

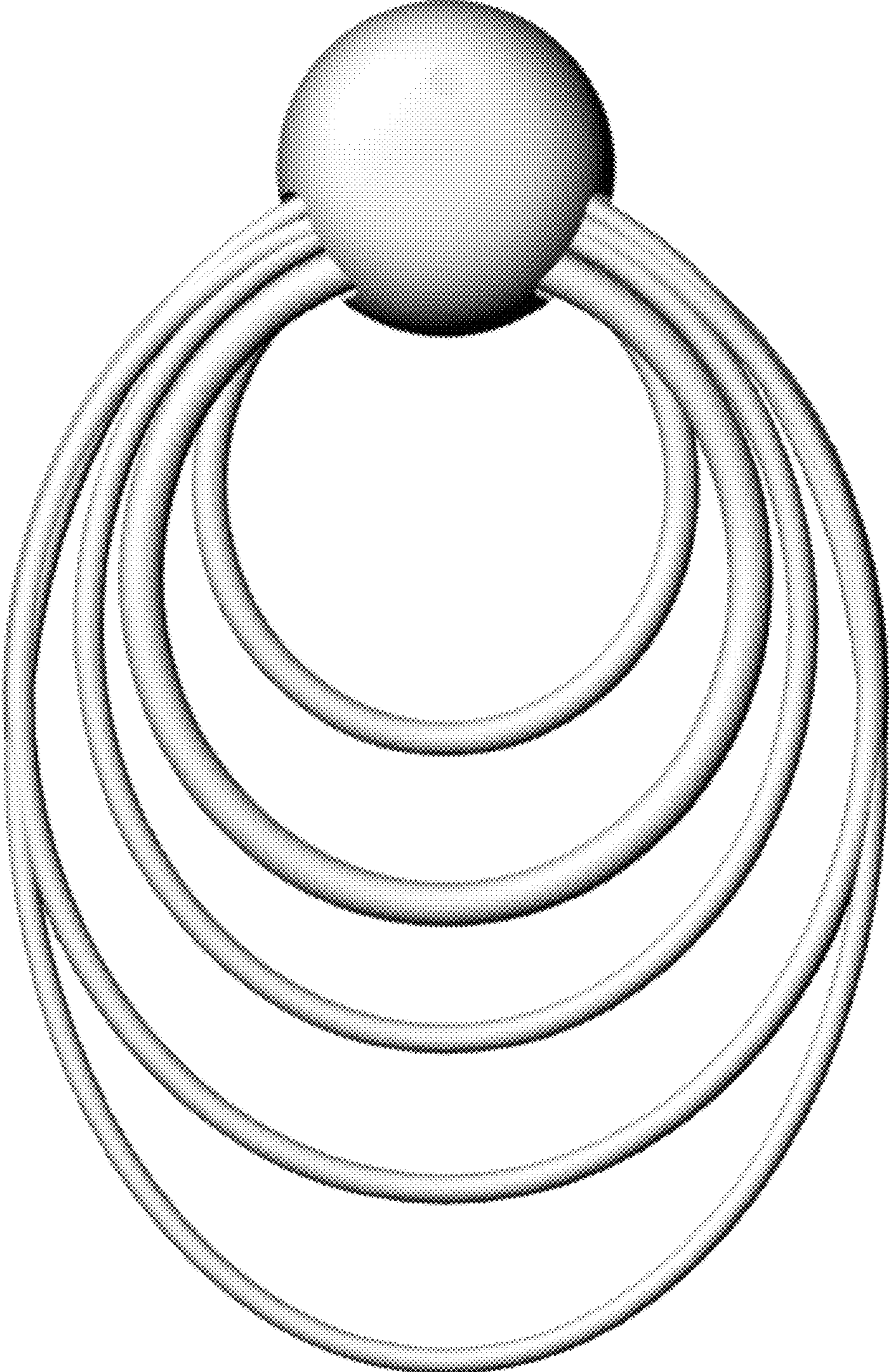

FIG. 14

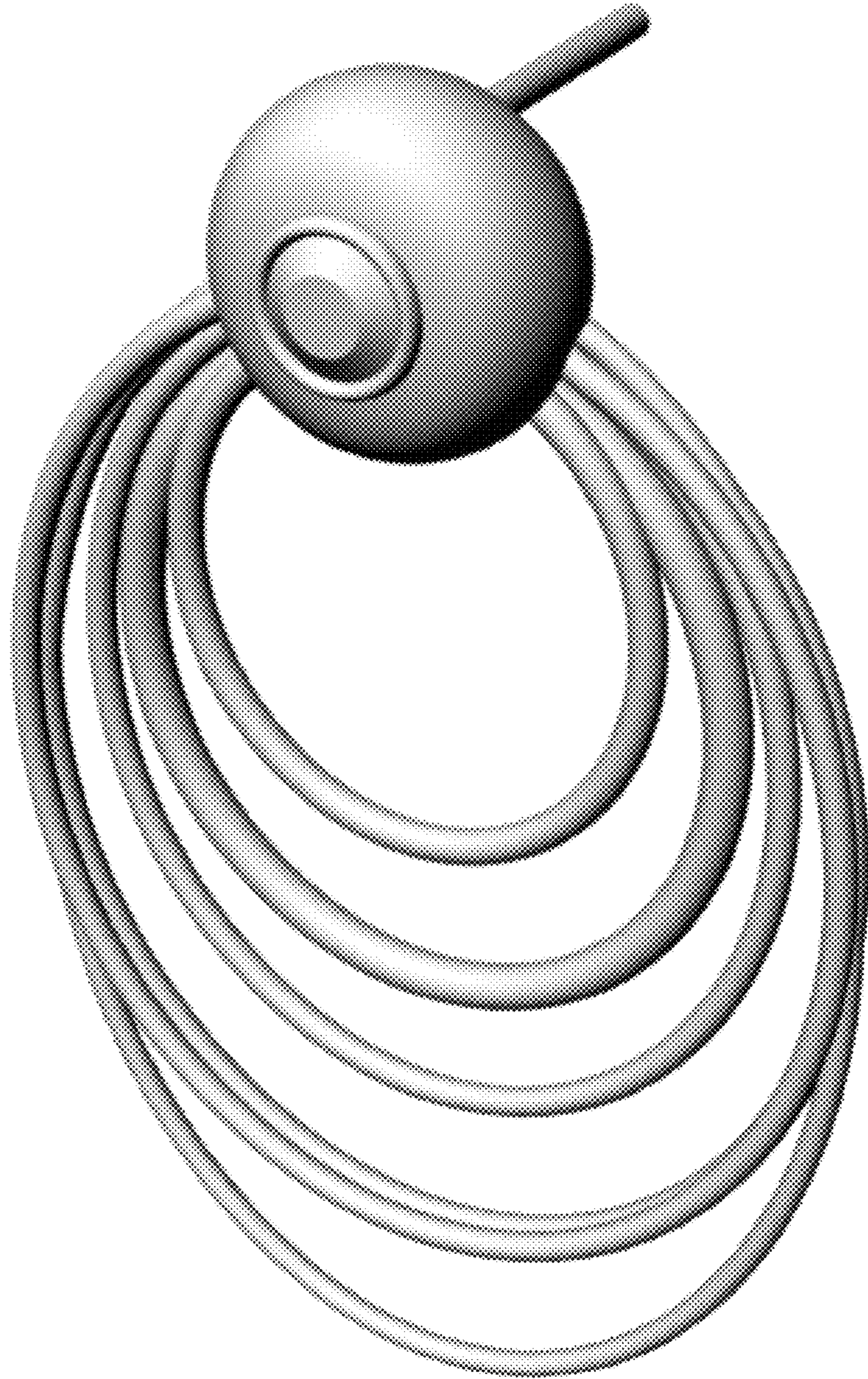

FIG. 15

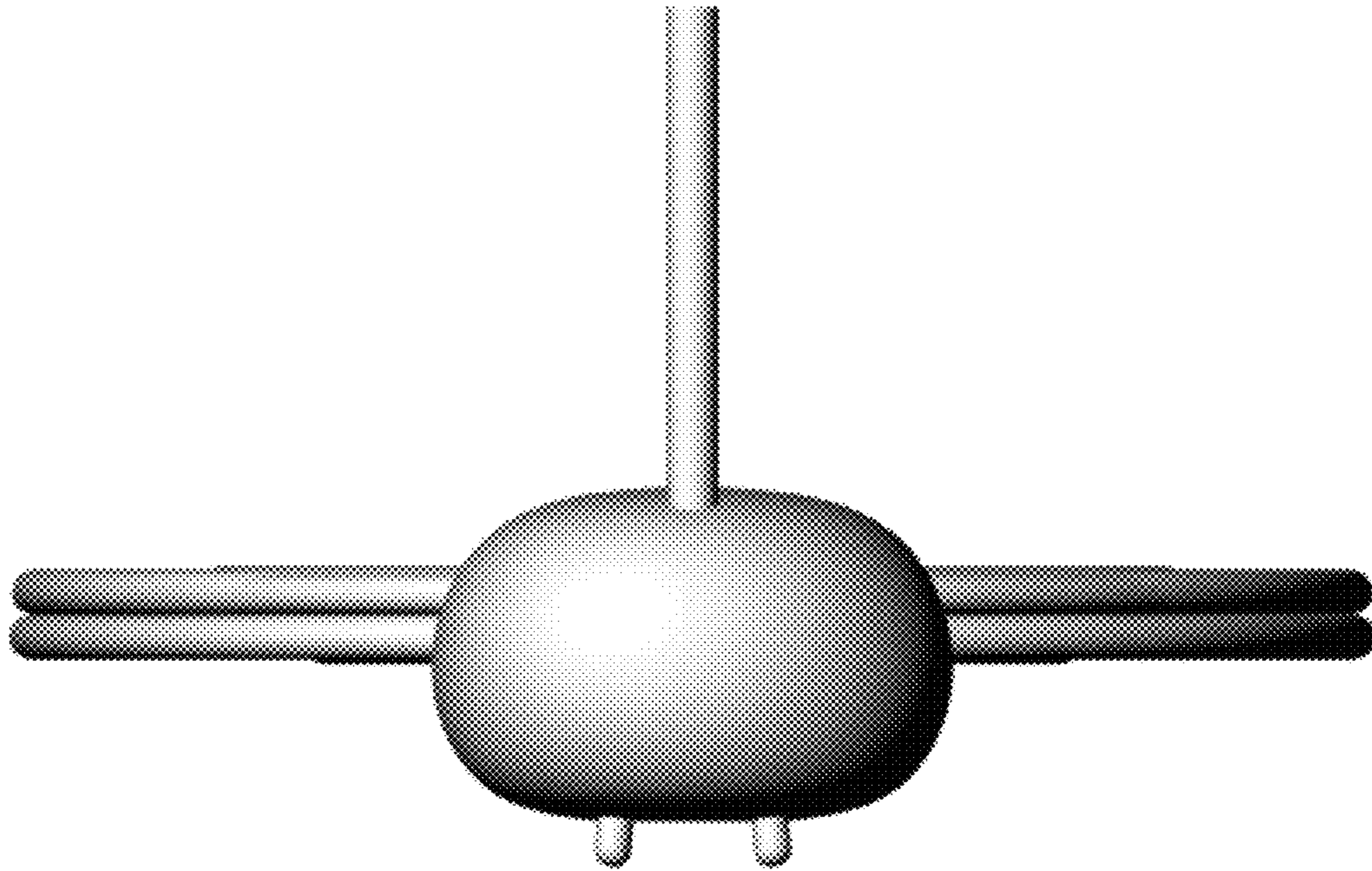

FIG. 16

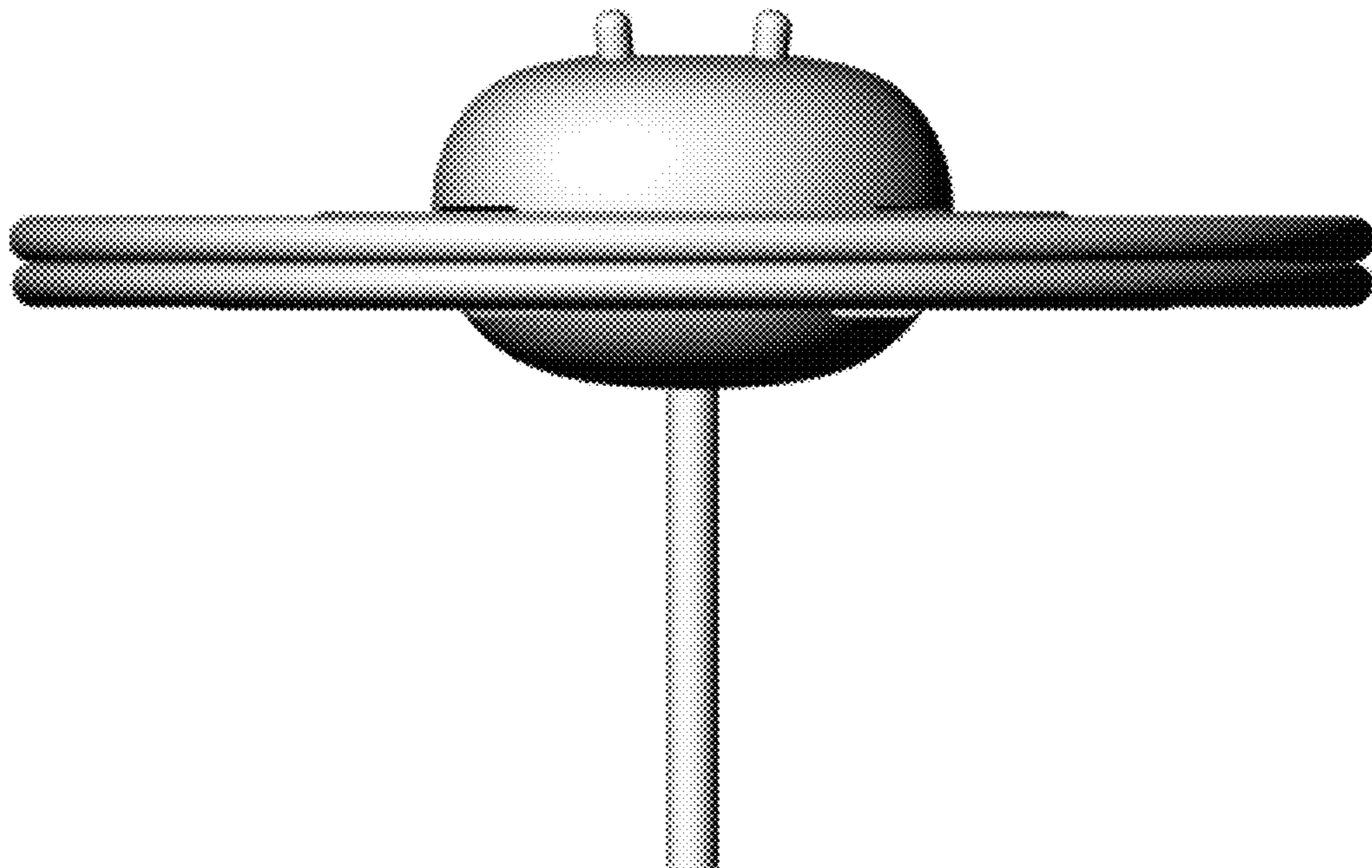

FIG. 17





FIG. 18

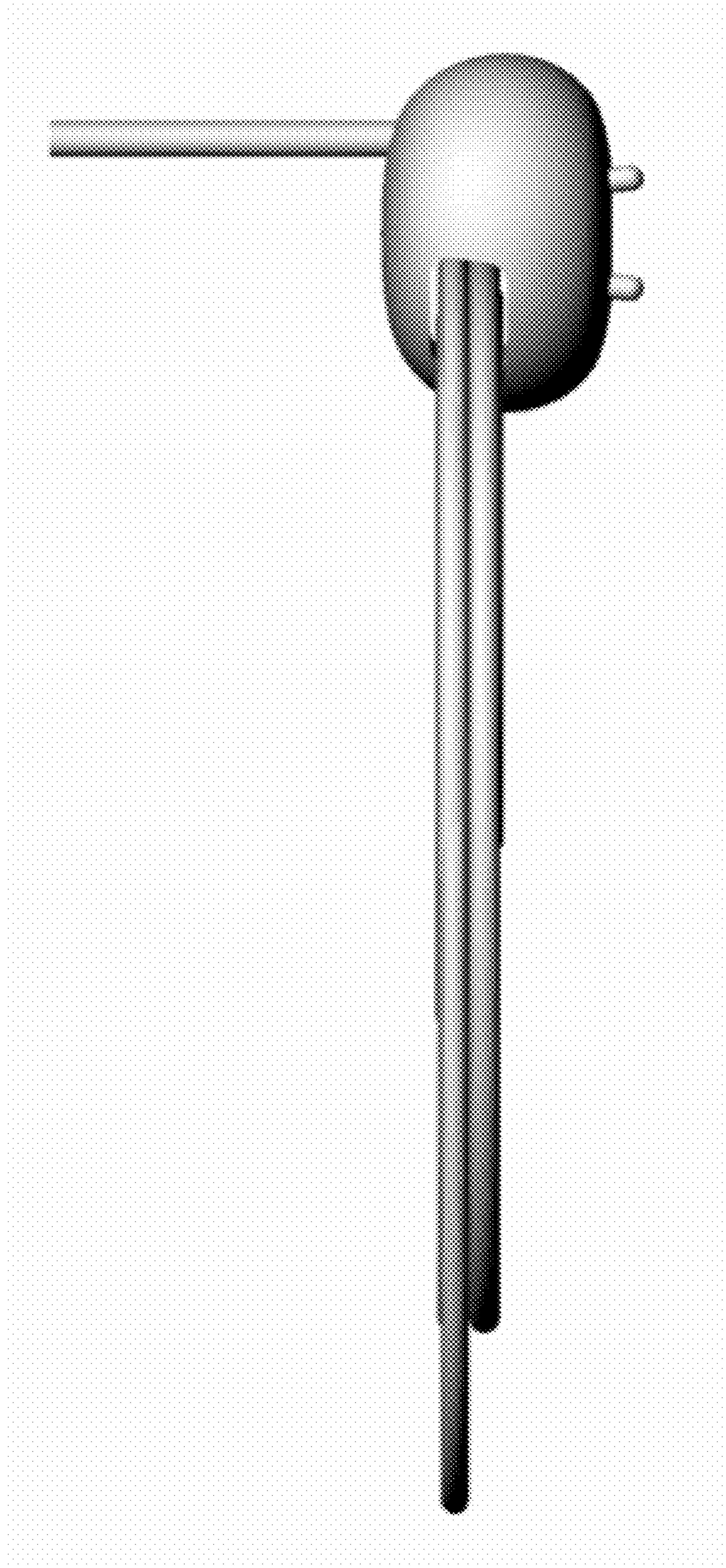

FIG. 19

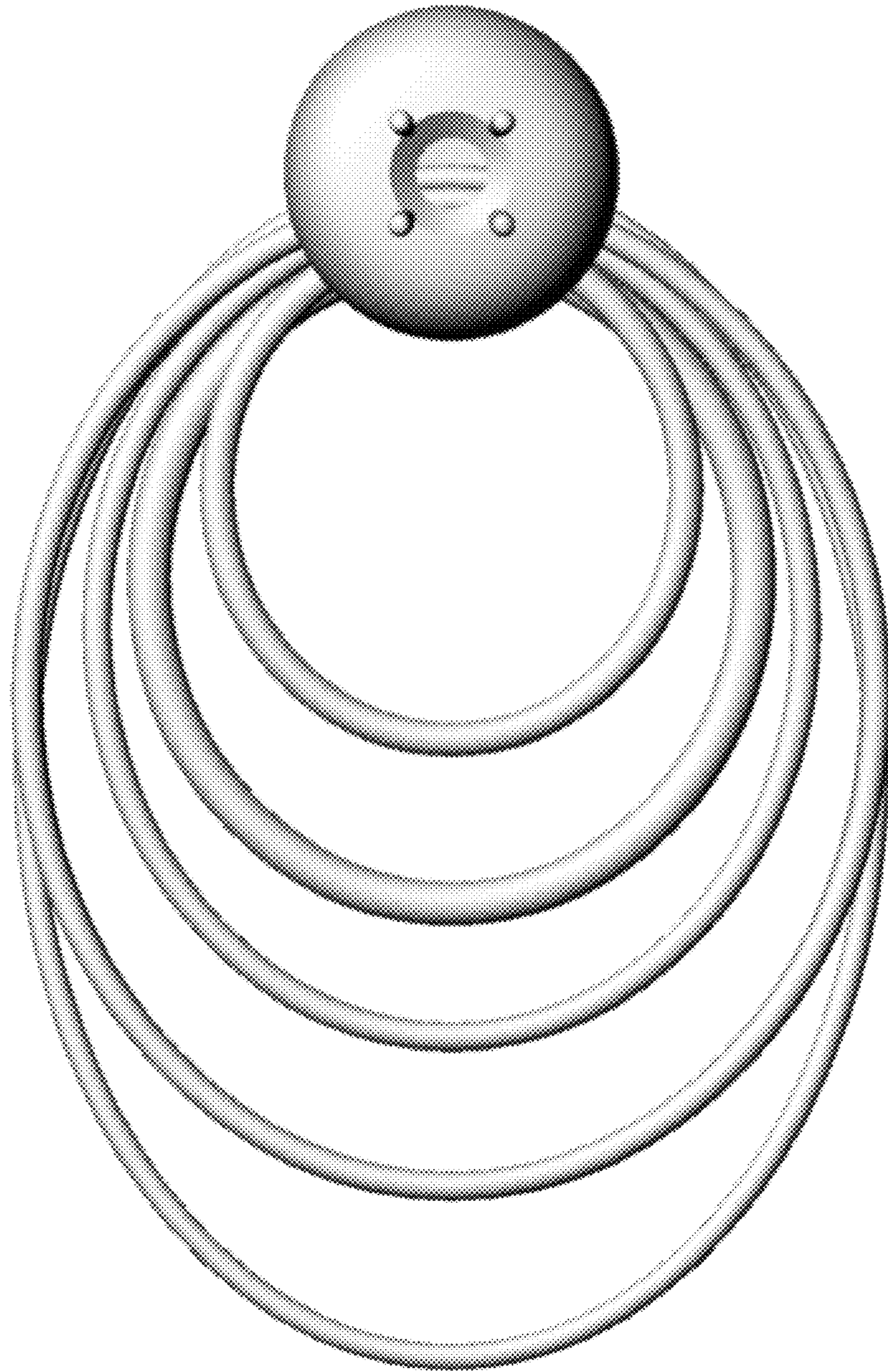

FIG. 20

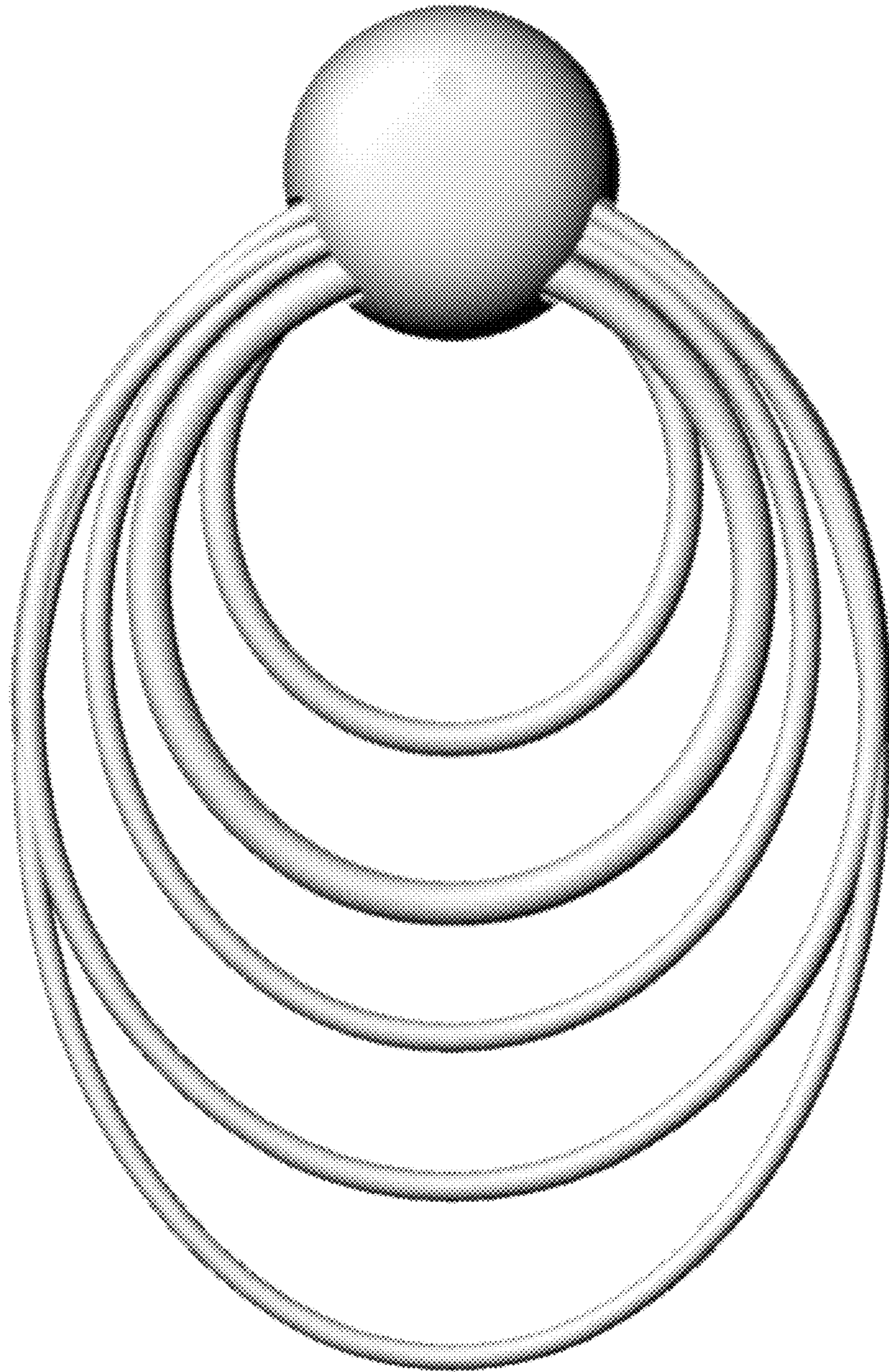

FIG. 21

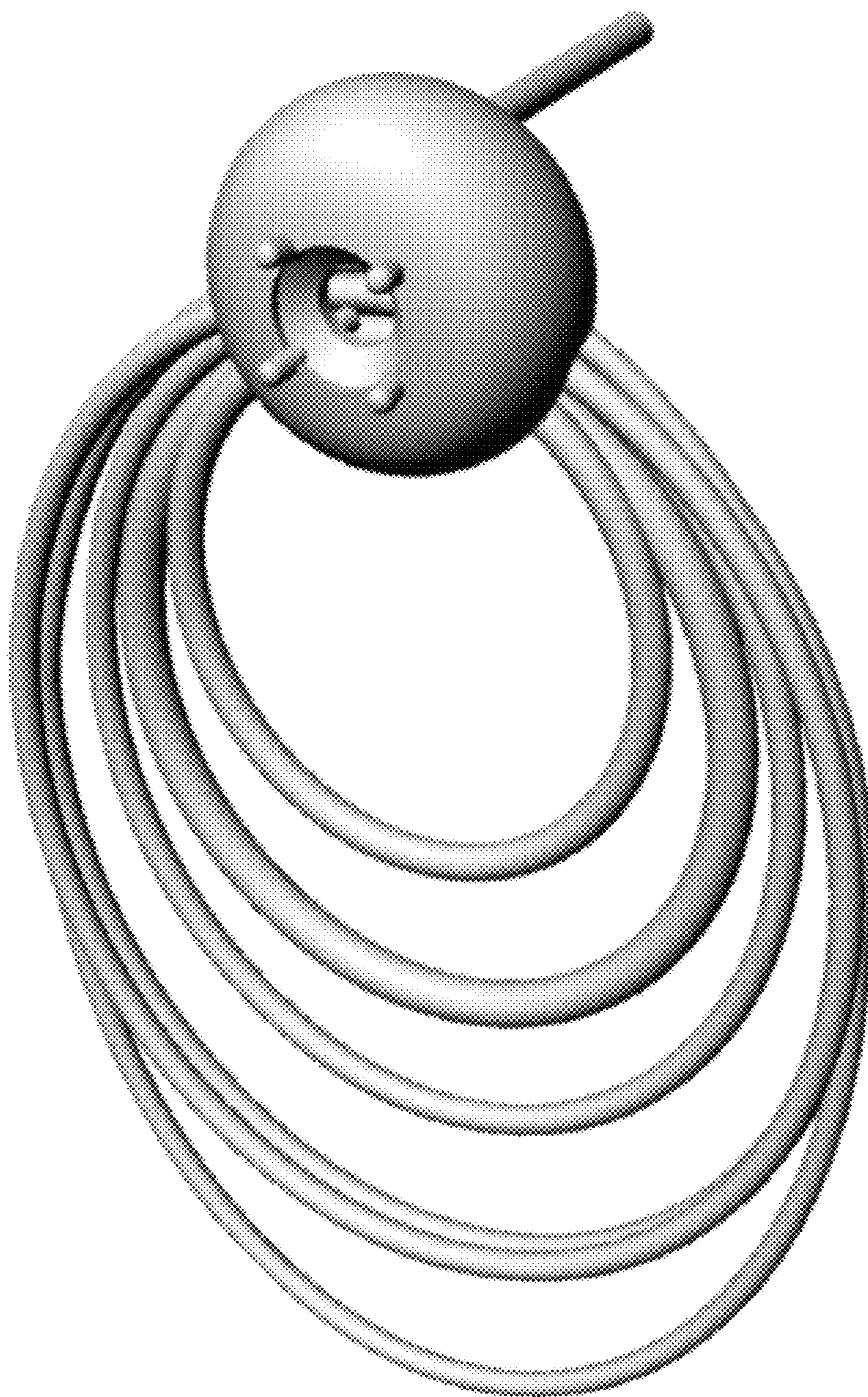

FIG. 22

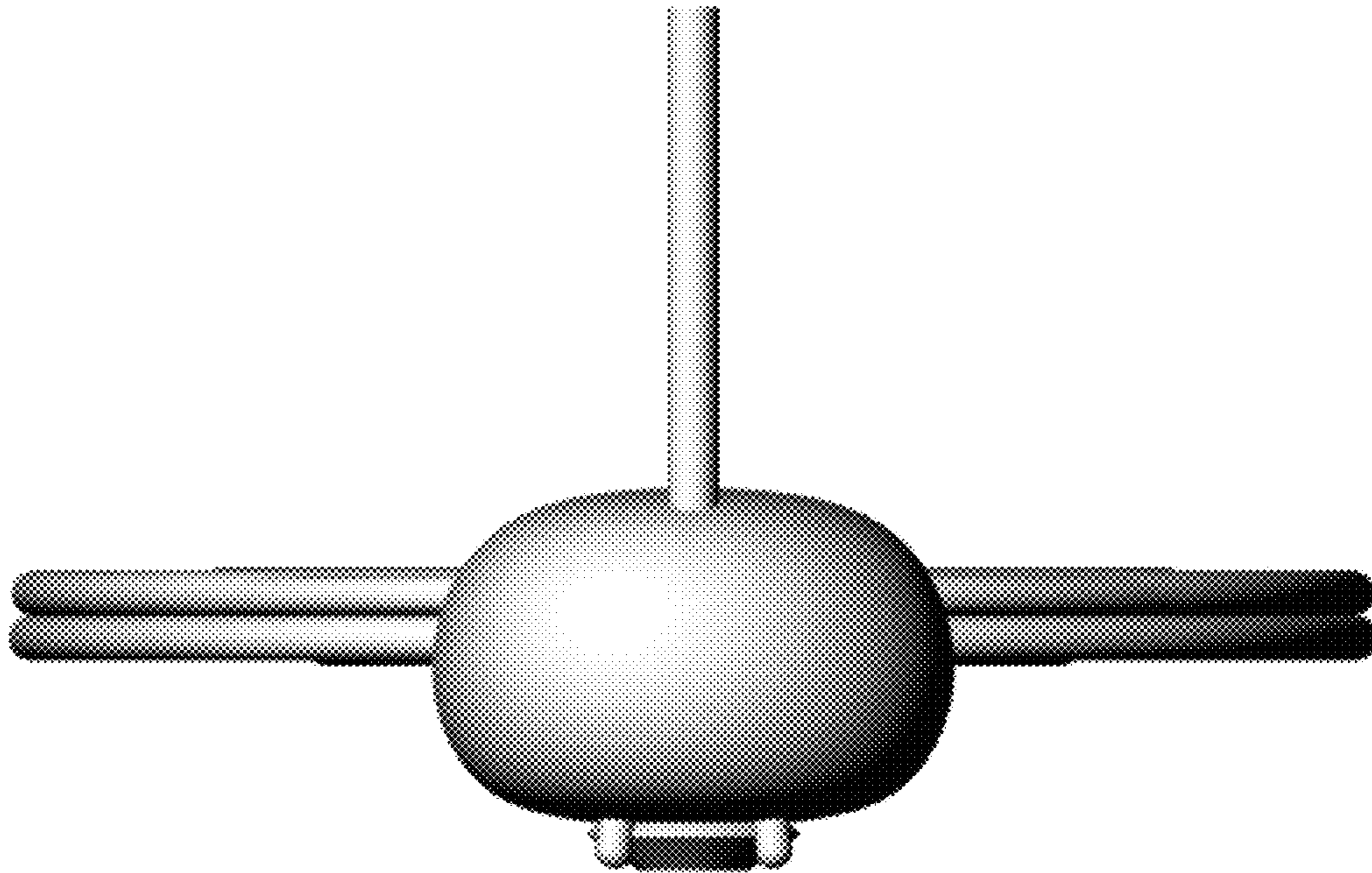

FIG. 23

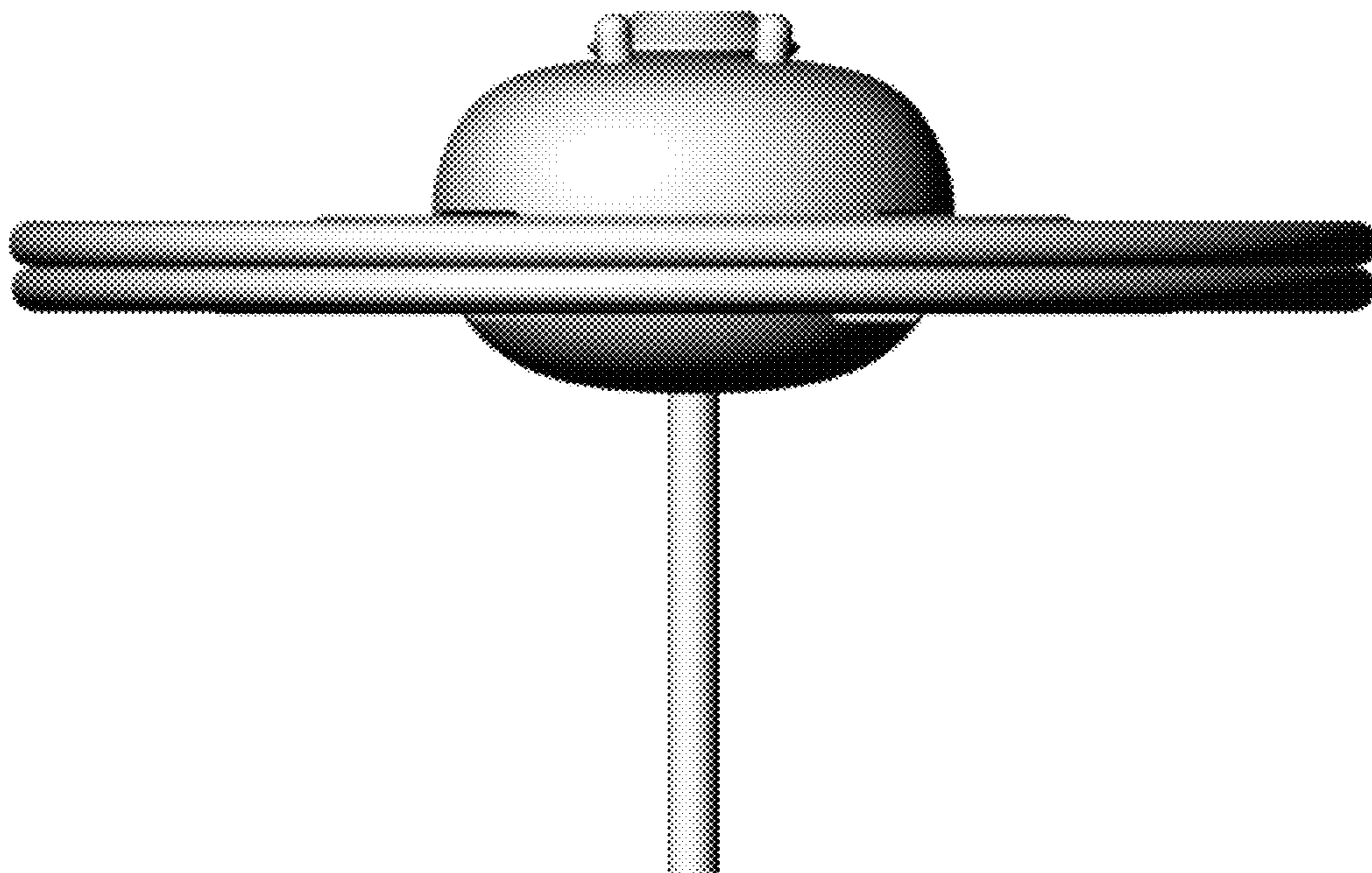

FIG. 24

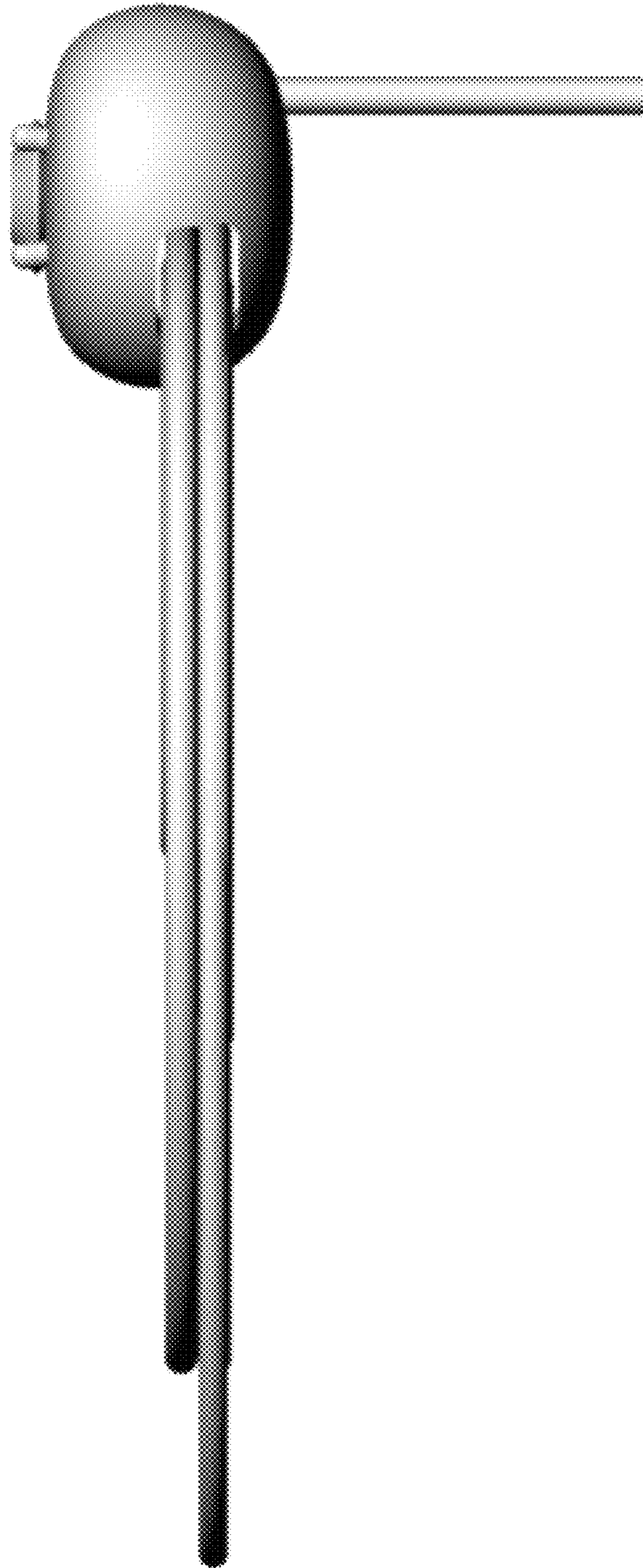

FIG. 25

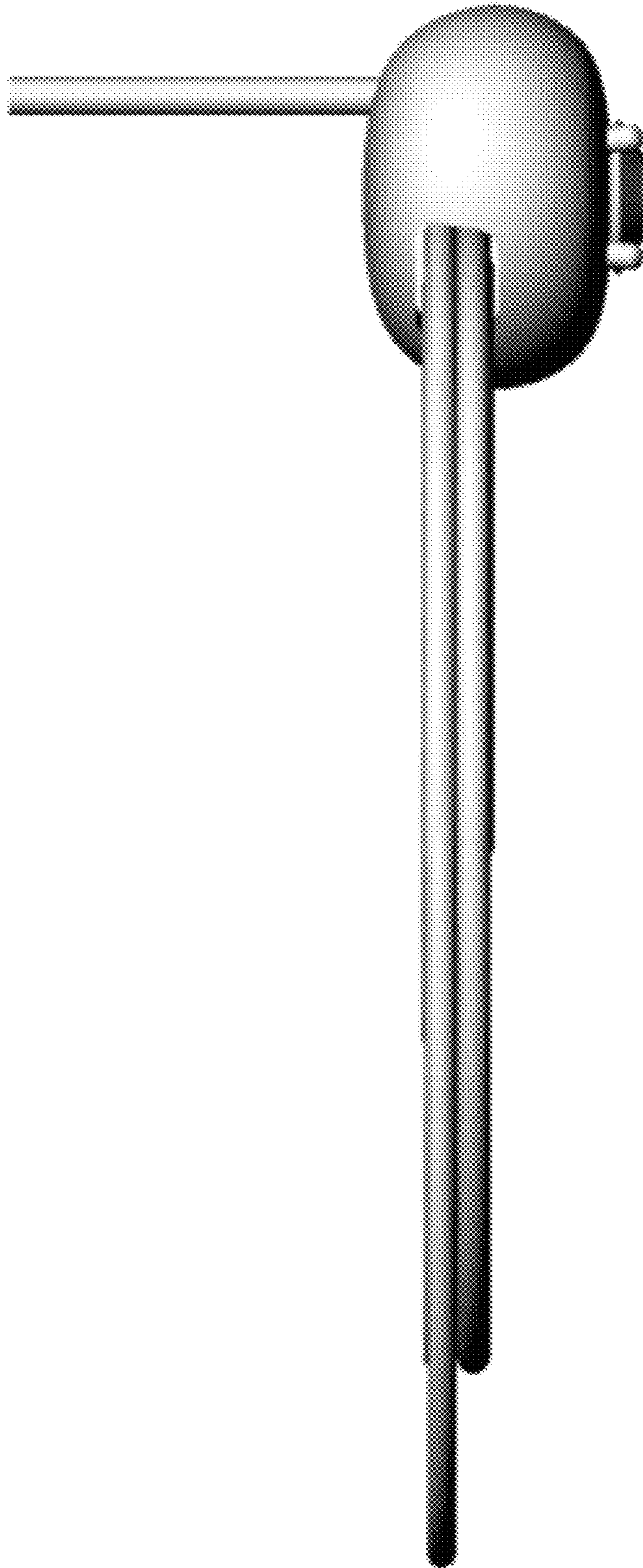

FIG. 26

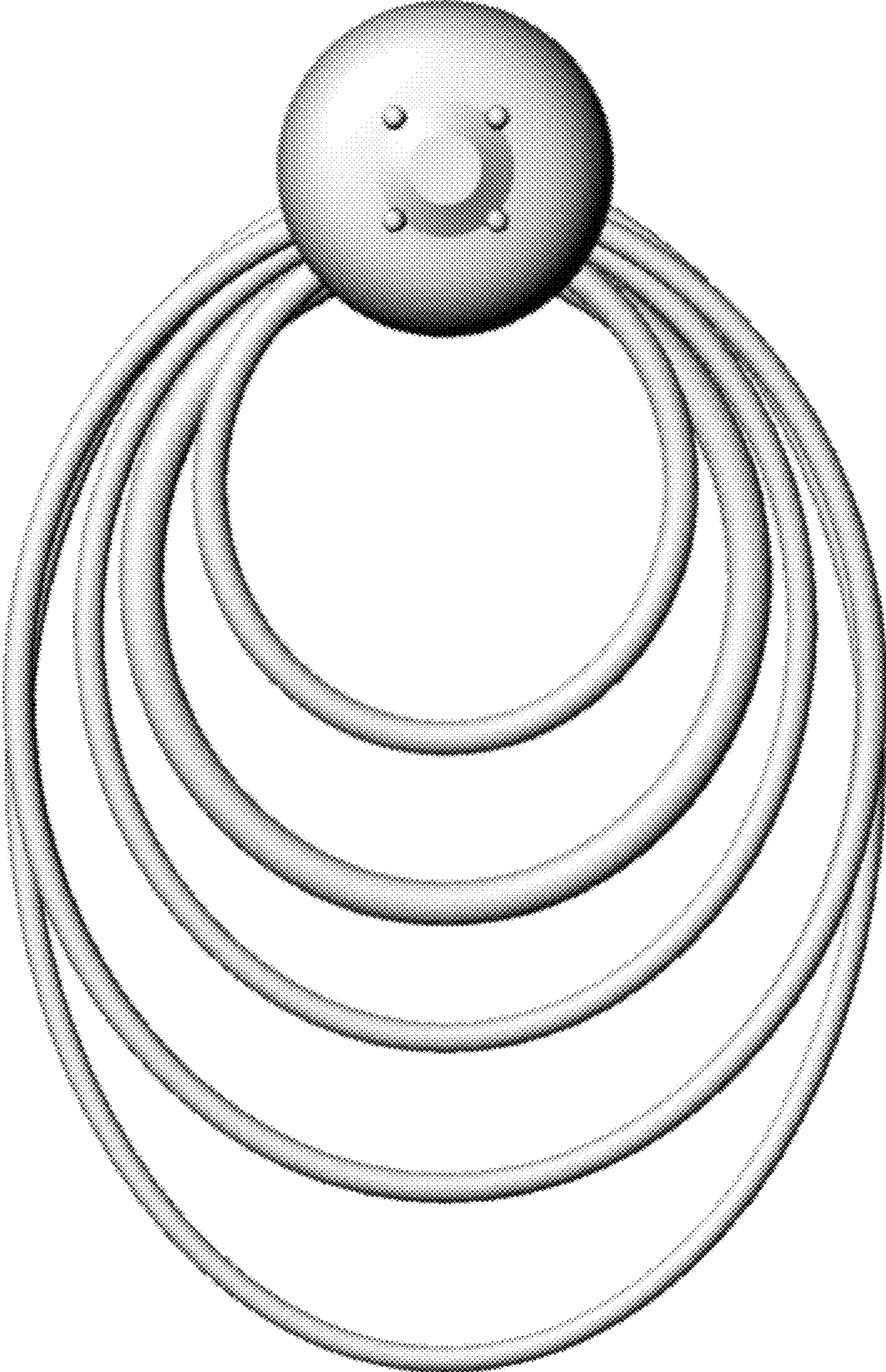



FIG. 27

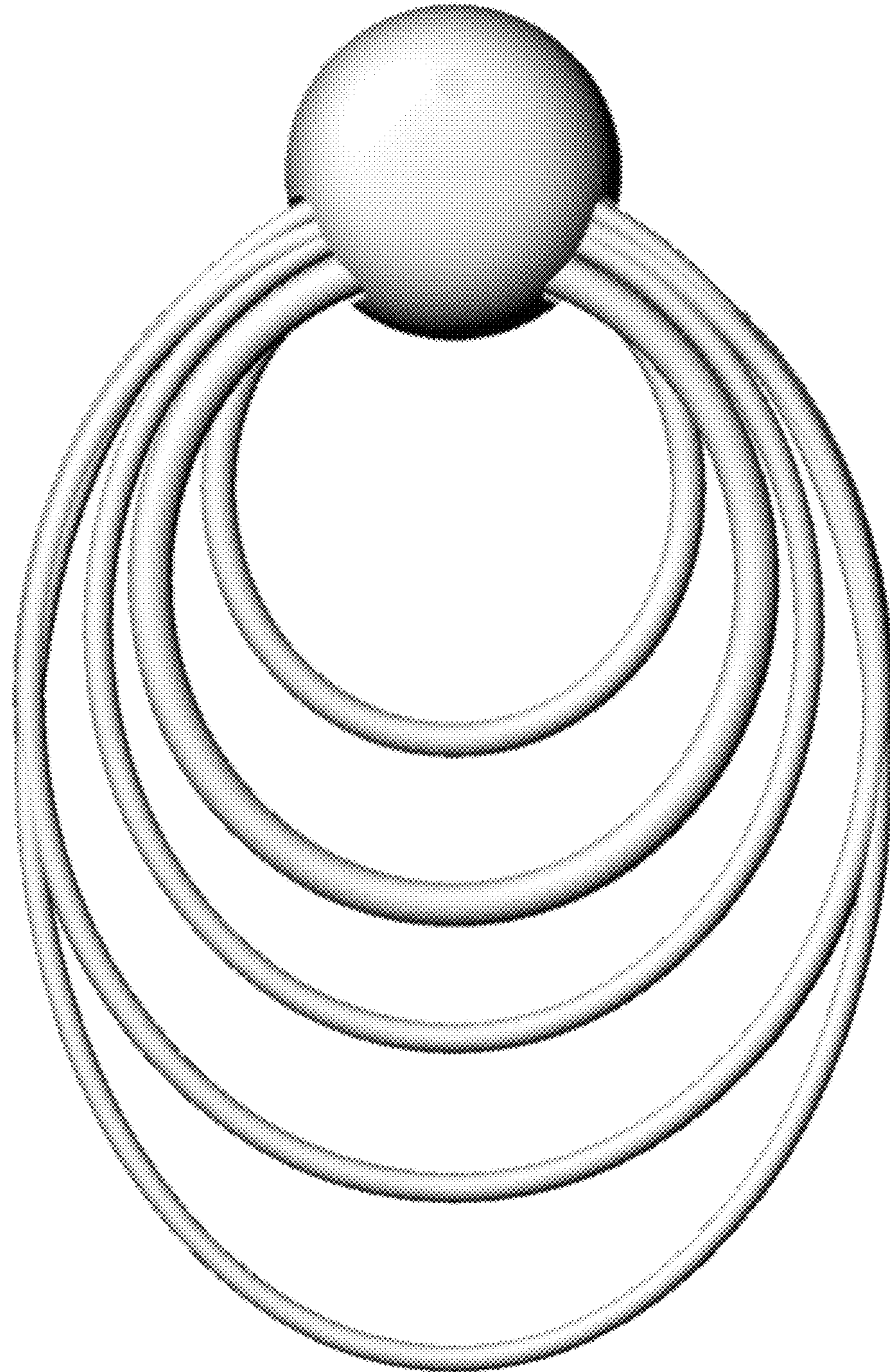

FIG. 28

