



US00D661130S

(12) **United States Design Patent**
Calco

(10) **Patent No.:** **US D661,130 S**

(45) **Date of Patent:** **** Jun. 5, 2012**

(54) **DESK**

(75) Inventor: **Wayne Calco**, Laguna Hills, CA (US)

(73) Assignee: **Atlantic Representations, Inc.**, Santa Fe Springs, CA (US)

(**) Term: **14 Years**

(21) Appl. No.: **29/390,063**

(22) Filed: **Apr. 19, 2011**

(51) **LOC (9) Cl.** **06-06**

(52) **U.S. Cl.** **D6/491; D6/426; D6/480; D6/499**

(58) **Field of Classification Search** D6/480-489,
D6/422-426, 511, 491; 108/50.01, 50.02,
108/29, 31; 312/194-196; 211/90.03, 181.1
See application file for complete search history.

(56) **References Cited**

U.S. PATENT DOCUMENTS

D389,336 S *	1/1998	Moore	D6/426
D389,667 S *	1/1998	Moore	D6/426
D427,804 S *	7/2000	Olson	D6/426

* cited by examiner

Primary Examiner — Janice Seeger

(74) *Attorney, Agent, or Firm* — Cisló & Thomas, LLP

(57) **CLAIM**

The ornamental design for a desk, as shown and described.

DESCRIPTION

FIG. 1 is a perspective view of my desk;
FIG. 2 is a front view thereof;
FIG. 3 is a rear view thereof;
FIG. 4 is a right side view thereof;
FIG. 5 is a left side view thereof;
FIG. 6 is a top view thereof; and,
FIG. 7 is a bottom view thereof.

The broken line portions of the disclosure are included for the purpose of illustrating environment and form no part of the claimed design.

1 Claim, 6 Drawing Sheets

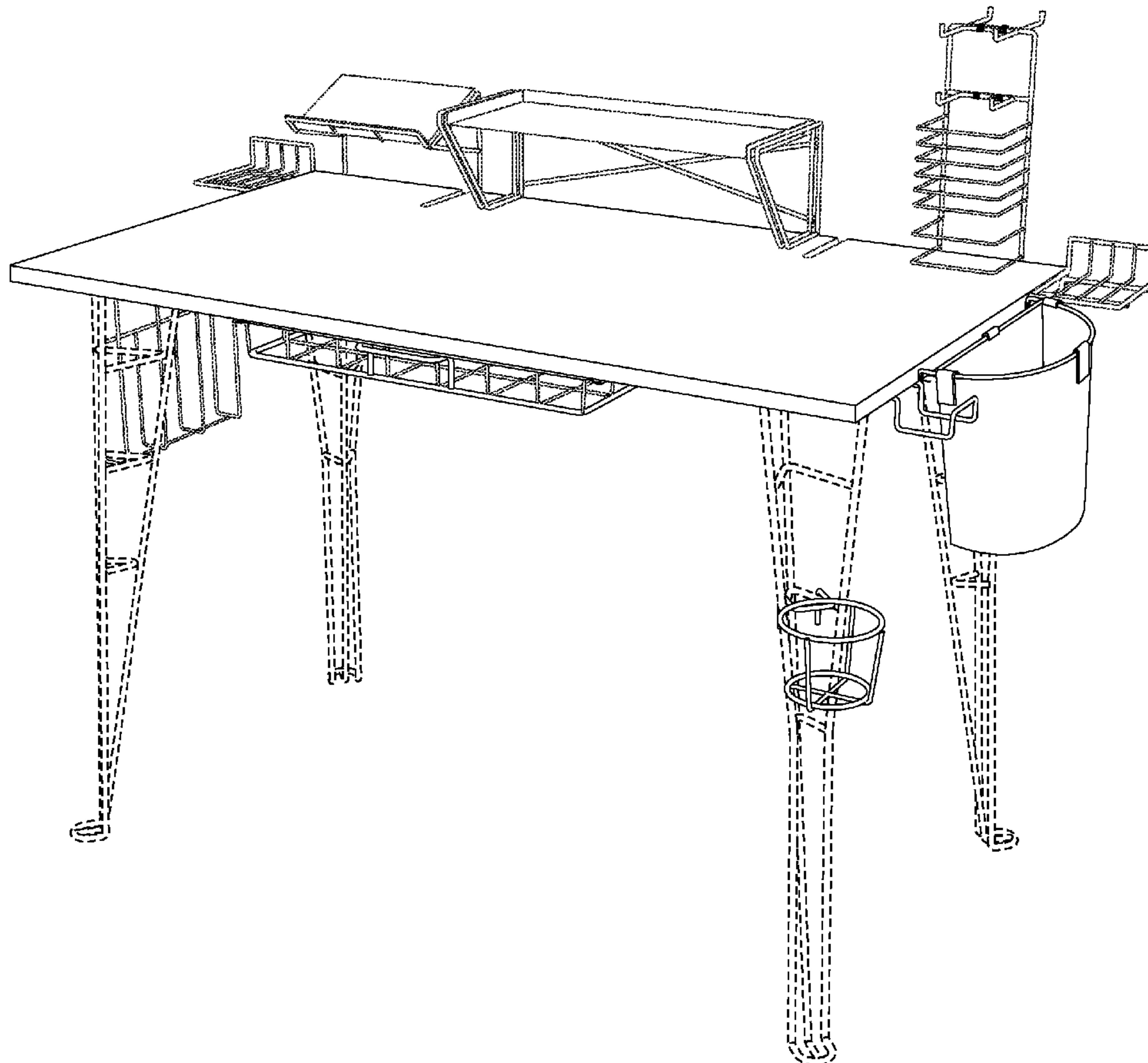

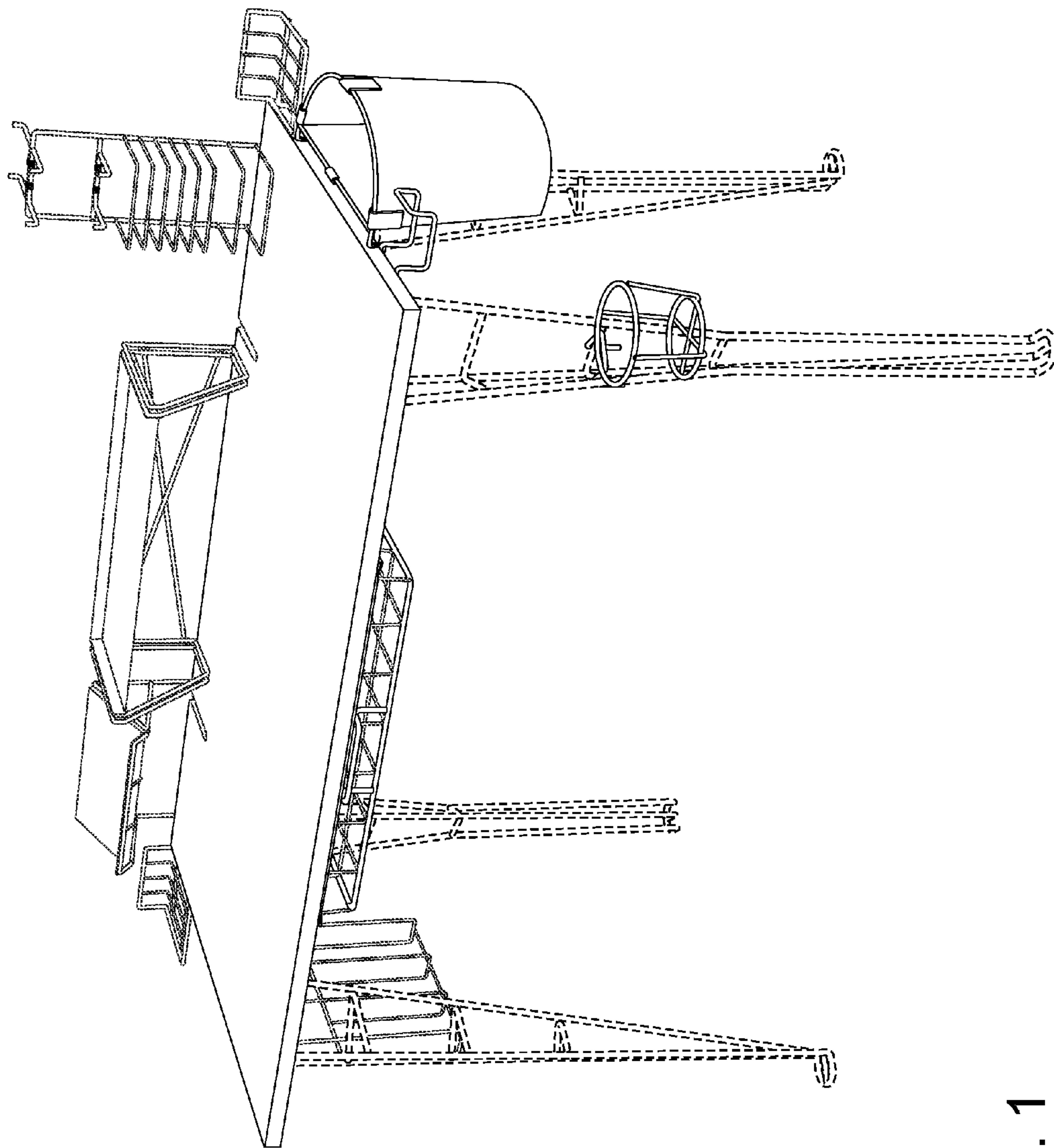

Fig. 1

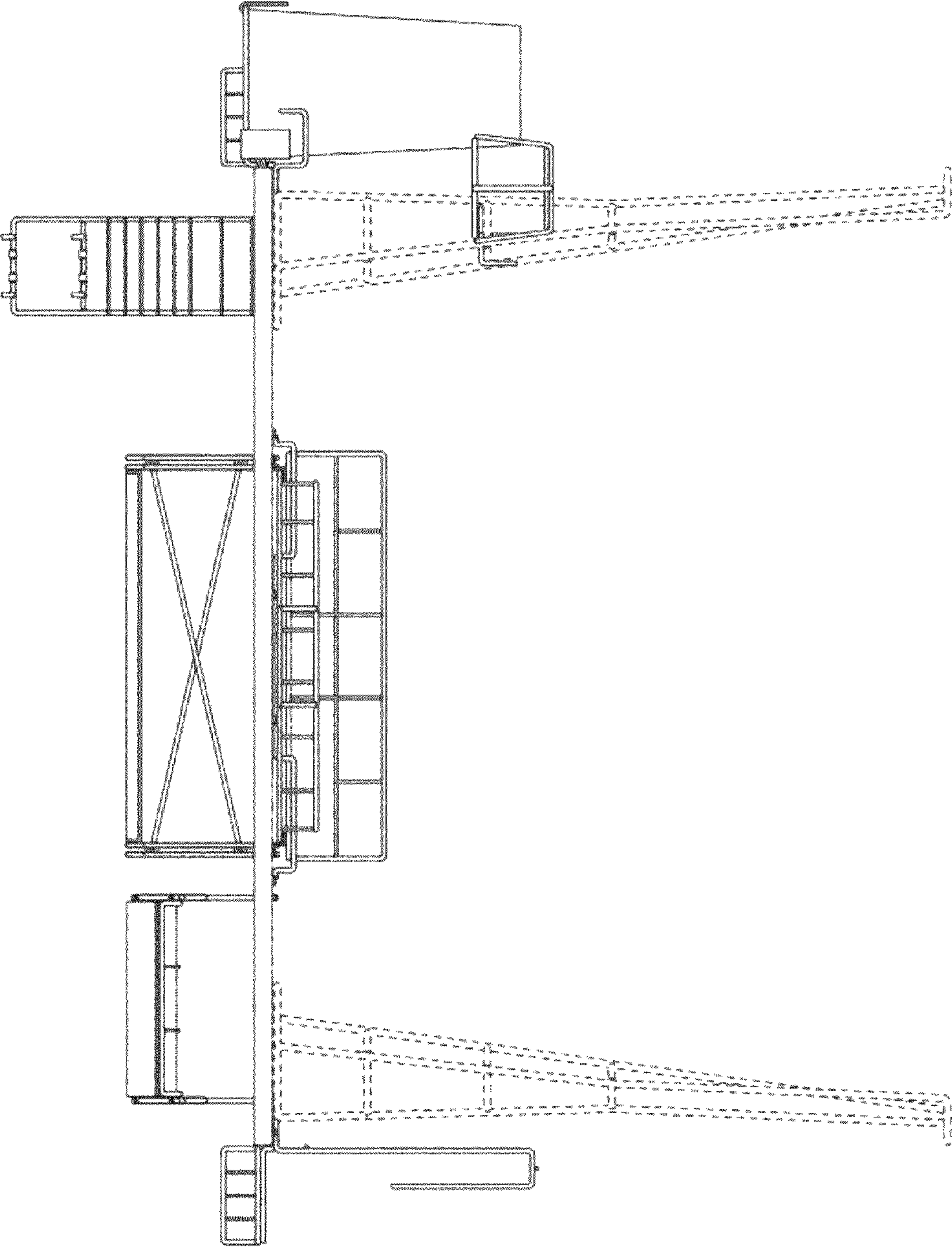

Fig. 2

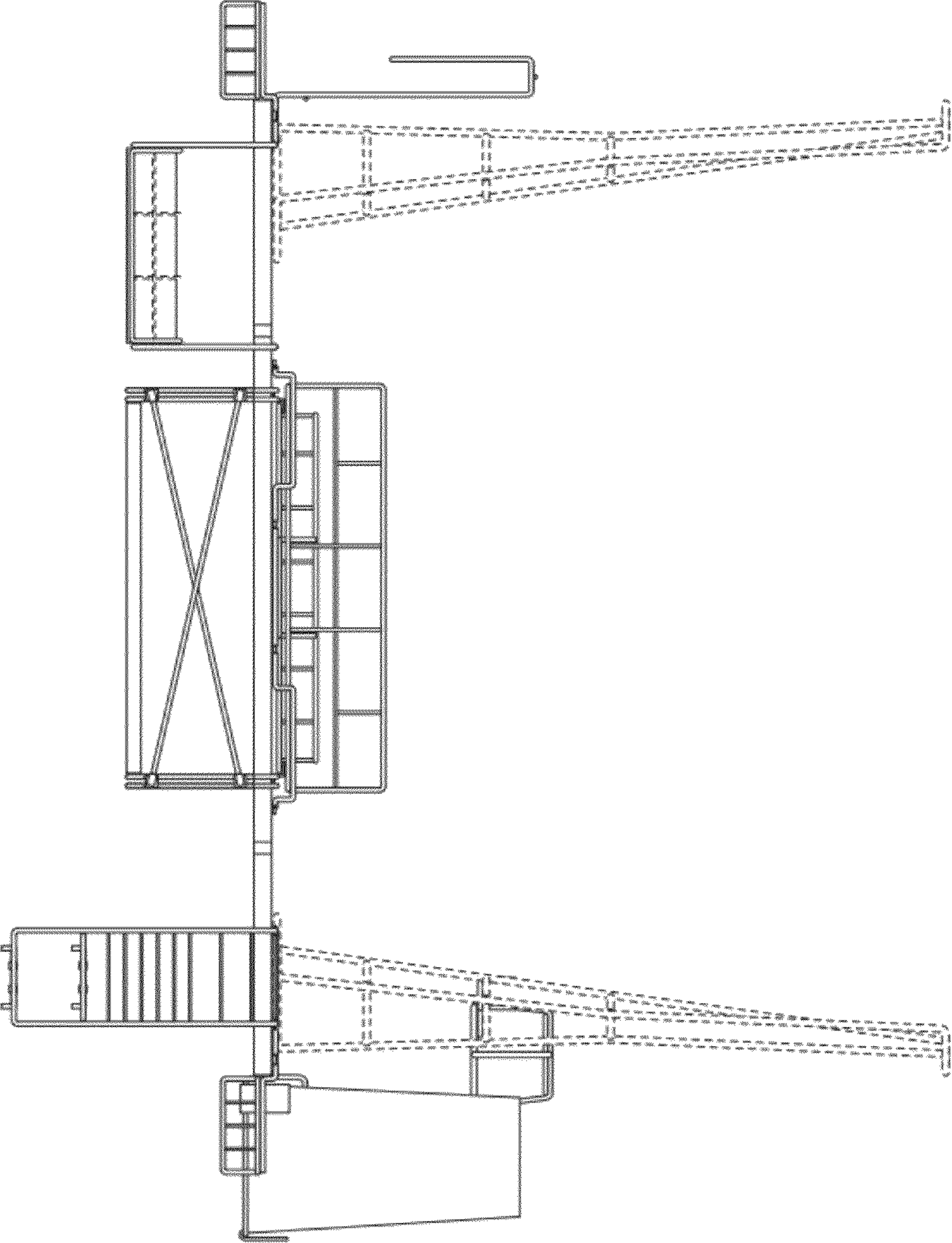

Fig. 3

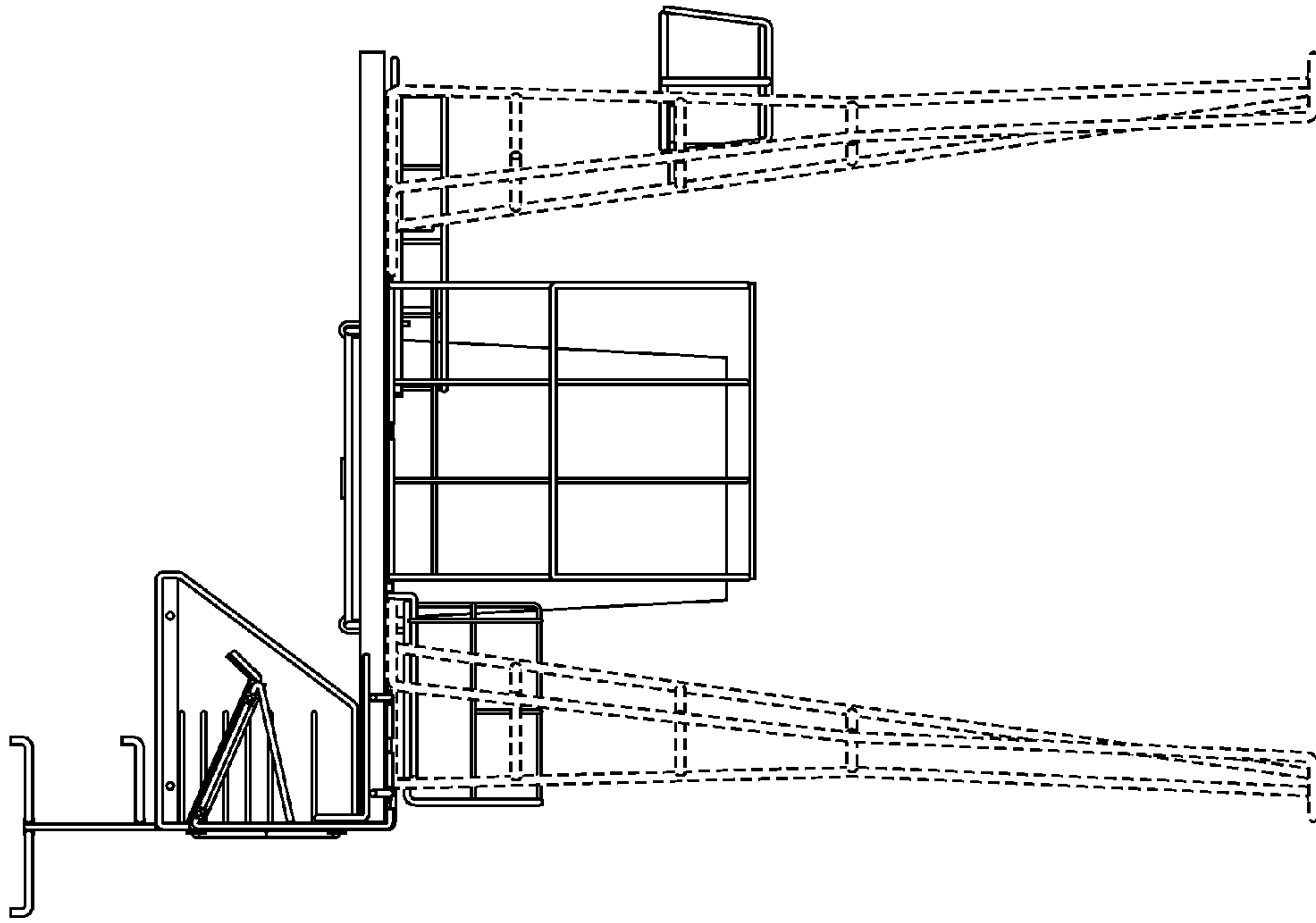

Fig. 5

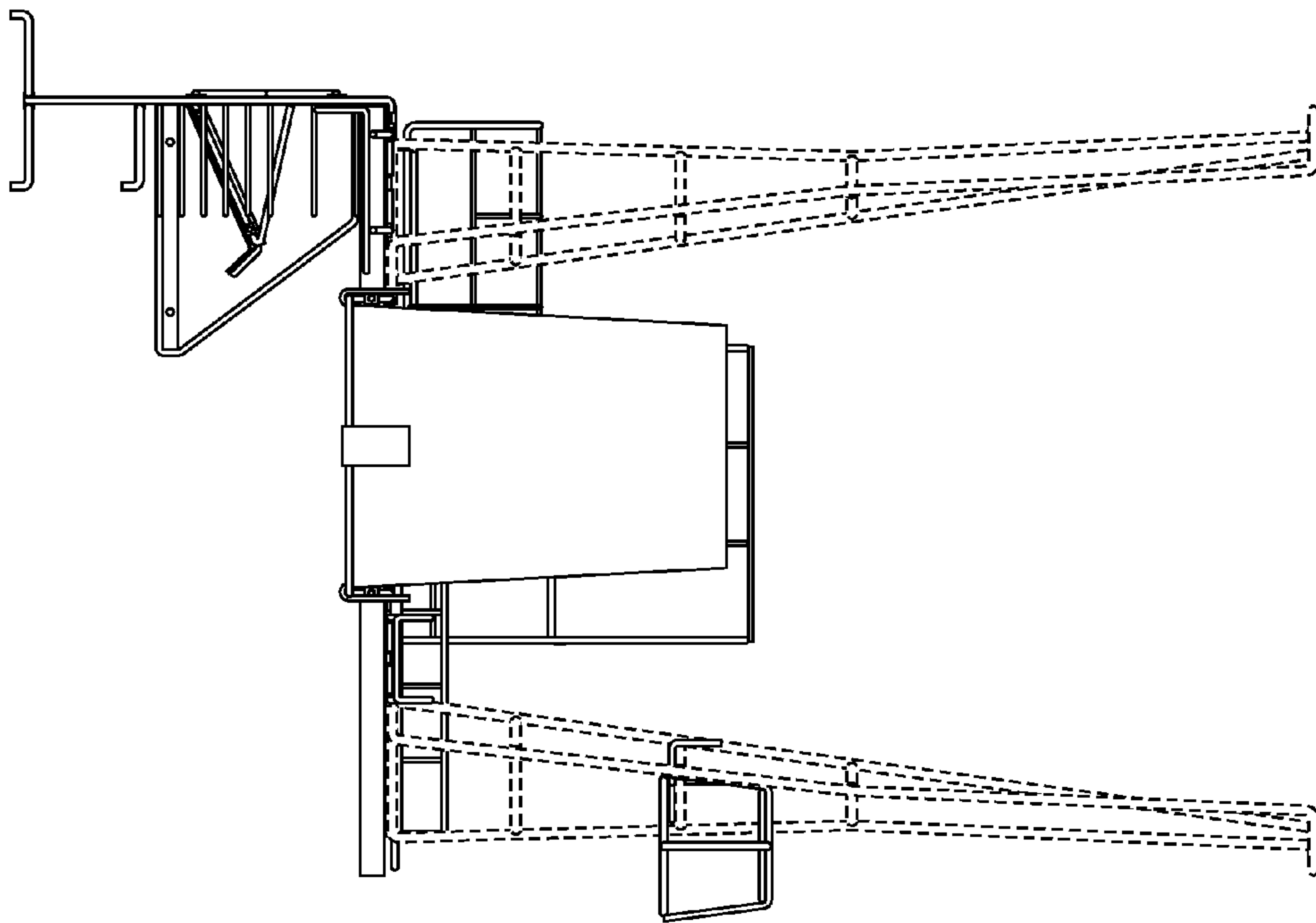

Fig. 4

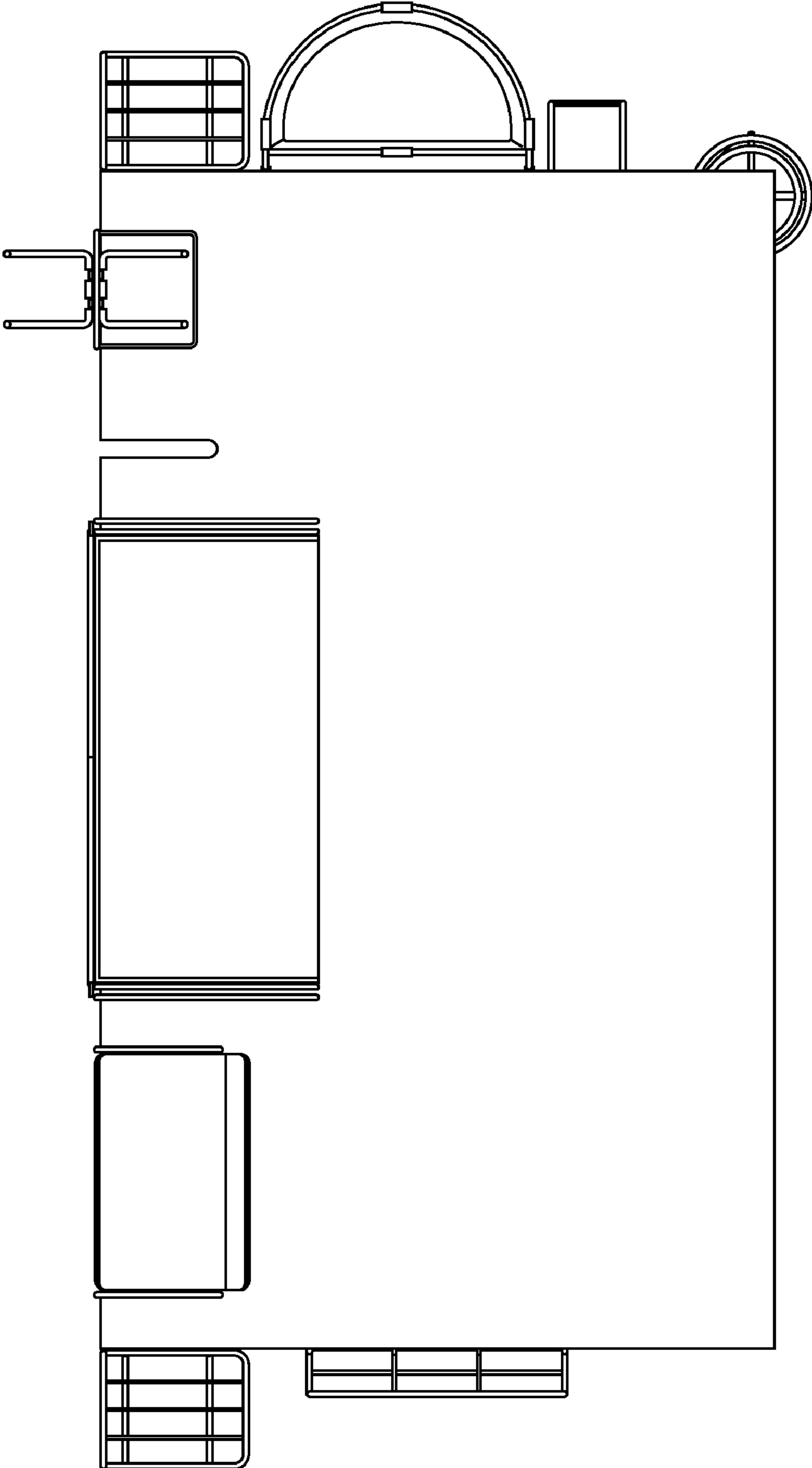

Fig. 6

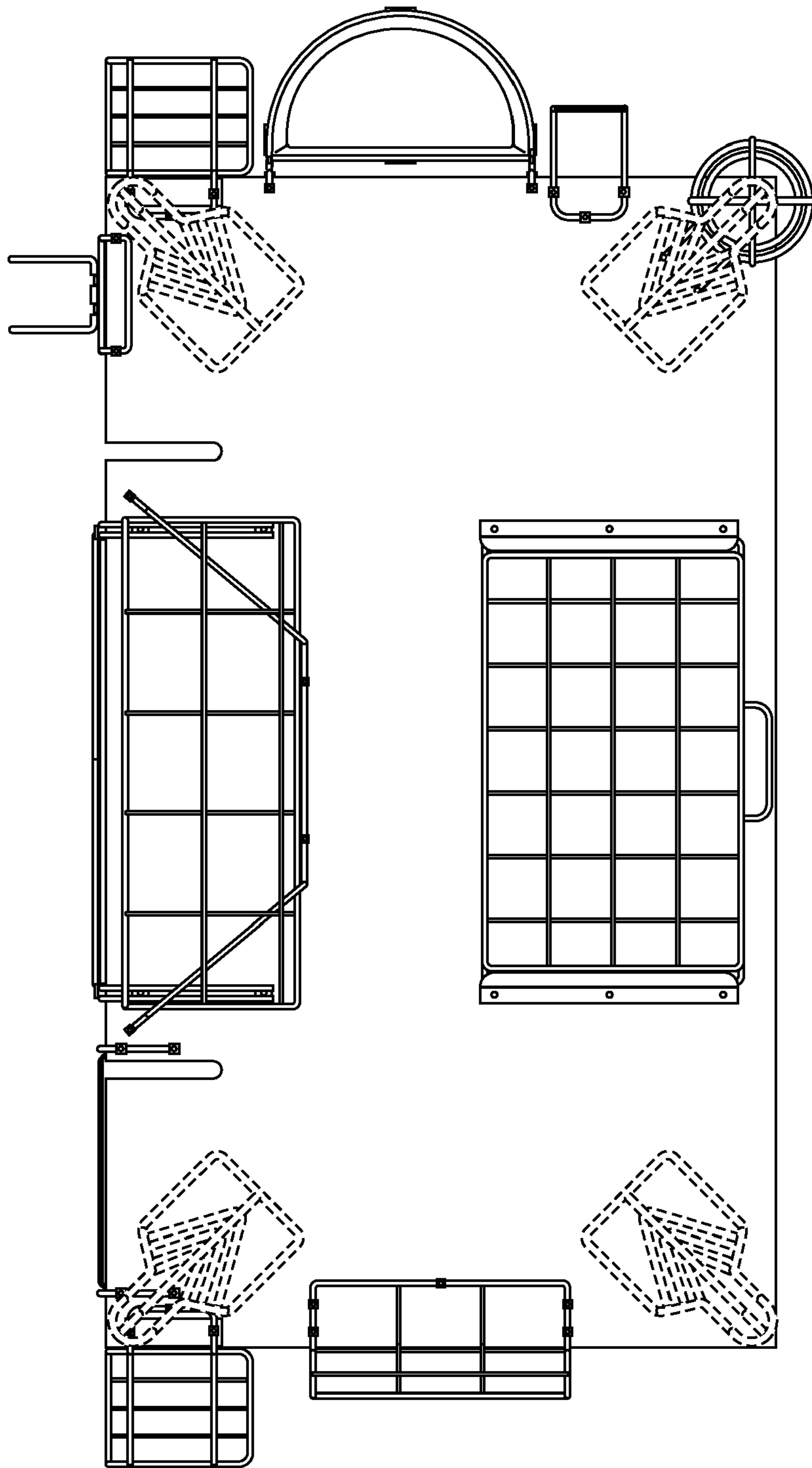

Fig. 7