



US00D660963S

(12) **United States Design Patent**  
**Detry**

(10) **Patent No.:** **US D660,963 S**  
(45) **Date of Patent:** **\*\* May 29, 2012**

(54) **SURGICAL INSTRUMENT**

(75) Inventor: **Marc Detry**, Ayze (FR)

(73) Assignee: **Zimmer Surgical SA**, Plan-les-Ouates (CH)

(\*\*) Term: **14 Years**

(21) Appl. No.: **29/399,444**

(22) Filed: **Aug. 15, 2011**

(51) **LOC (9) Cl.** ..... **24-02**

(52) **U.S. Cl.** ..... **D24/146**

(58) **Field of Classification Search** ..... D24/146,  
D24/147; D8/20, 26, 64; 606/79, 82, 167,  
606/176-178; 30/338, 339, 392

See application file for complete search history.

(56) **References Cited**

U.S. PATENT DOCUMENTS

|              |      |         |                 |         |
|--------------|------|---------|-----------------|---------|
| 1,429,162    | A *  | 9/1922  | Oberlander      | 30/151  |
| 3,899,828    | A *  | 8/1975  | Bosco           | 30/151  |
| 4,558,517    | A *  | 12/1985 | Gringer         | 30/169  |
| 4,922,614    | A *  | 5/1990  | Machida         | 30/339  |
| 5,433,004    | A *  | 7/1995  | Thompson et al. | 30/169  |
| 5,916,218    | A *  | 6/1999  | Hagen et al.    | 606/82  |
| 6,503,253    | B1 * | 1/2003  | Fletcher et al. | 606/79  |
| 6,775,912    | B2 * | 8/2004  | Panfili et al.  | 30/169  |
| D586,512     | S *  | 2/2009  | van Deursen     | D32/46  |
| D642,264     | S *  | 7/2011  | Fisher et al.   | D24/146 |
| D654,590     | S *  | 2/2012  | Fisher et al.   | D24/146 |
| 2004/0199167 | A1 * | 10/2004 | Fletcher et al. | 606/79  |
| 2007/0169353 | A1 * | 7/2007  | Wu              | 30/155  |

\* cited by examiner

*Primary Examiner* — Ian Simmons

*Assistant Examiner* — Carissa C Fitts

(74) *Attorney, Agent, or Firm* — Cermak Nakajima LLP;  
Adam J. Cermak

(57) **CLAIM**

The ornamental design for a surgical instrument, as shown and described.

**DESCRIPTION**

FIG. 1 is a top, rear, left perspective views of a surgical instrument, showing my new design;

FIG. 2 is a top plan view of the surgical instrument shown in FIG. 1;

FIG. 3 is a front side elevational view of the surgical instrument shown in FIG. 1;

FIG. 4 is a right elevational view of the surgical instrument shown in FIG. 1;

FIG. 5 is a left side elevational view of the surgical instrument shown in FIG. 1;

FIG. 6 is a rear side elevational view of the surgical instrument shown in FIG. 1;

FIG. 7 is a bottom plan view of the surgical instrument shown in FIG. 1;

FIG. 8 is a top, rear, left perspective view of the surgical instrument shown in FIG. 1;

FIG. 9 is a top plan view of the surgical instrument shown in FIG. 1;

FIG. 10 is a front elevational view of the surgical instrument shown in FIG. 1;

FIG. 11 is a right elevational view of the surgical instrument shown in FIG. 1;

FIG. 12 is a left side elevational view of the surgical instrument shown in FIG. 1;

FIG. 13 is a rear elevational view of the surgical instrument shown in FIG. 1; and,

FIG. 14 is a bottom plan view of the surgical instrument shown in FIG. 1.

The dash-dash broken lines represent unclaimed subject matter. The dot-dash broken lines which show a blade detail are for environmental purposes only. The broken lines form no part of the claimed design.

**1 Claim, 10 Drawing Sheets**

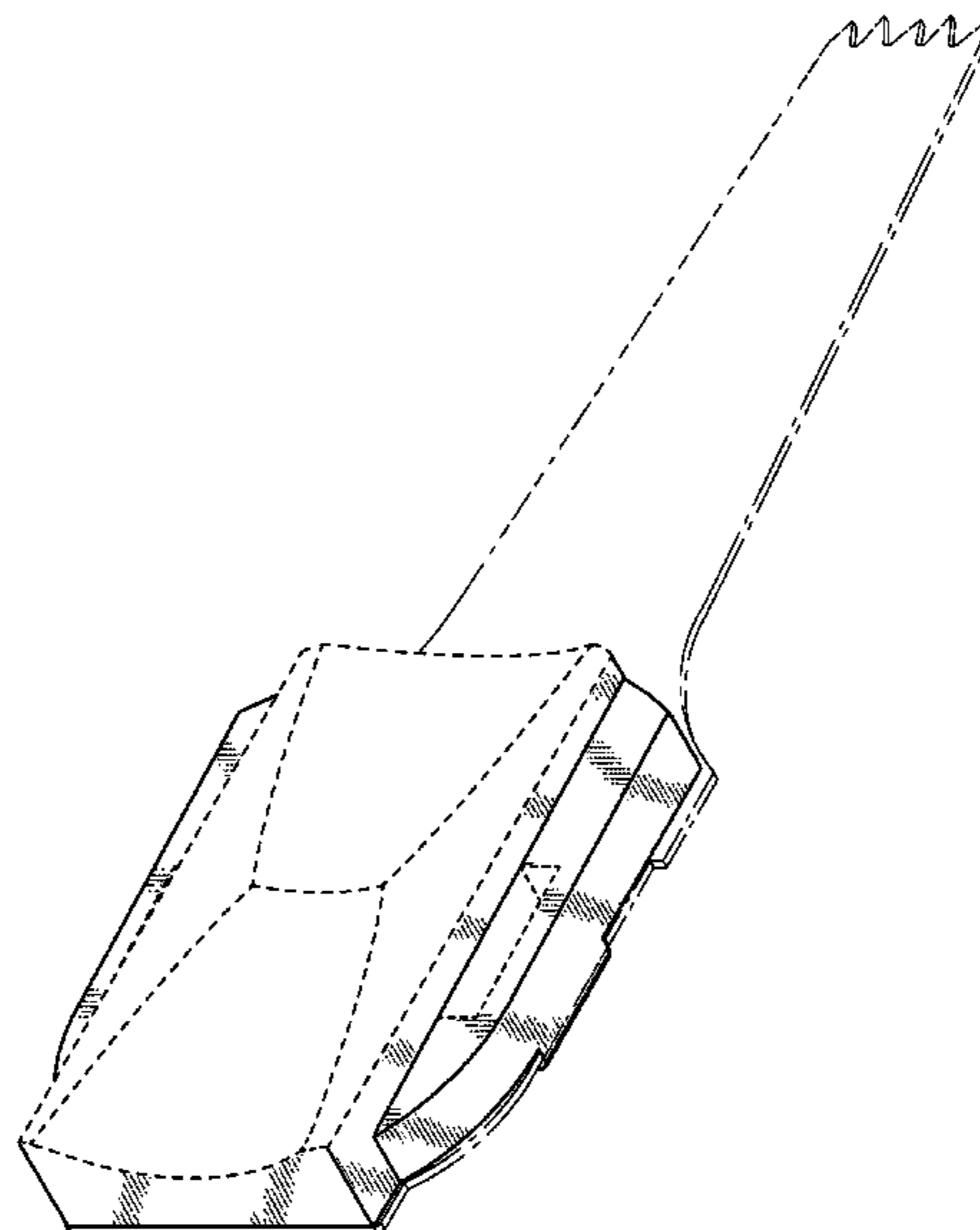

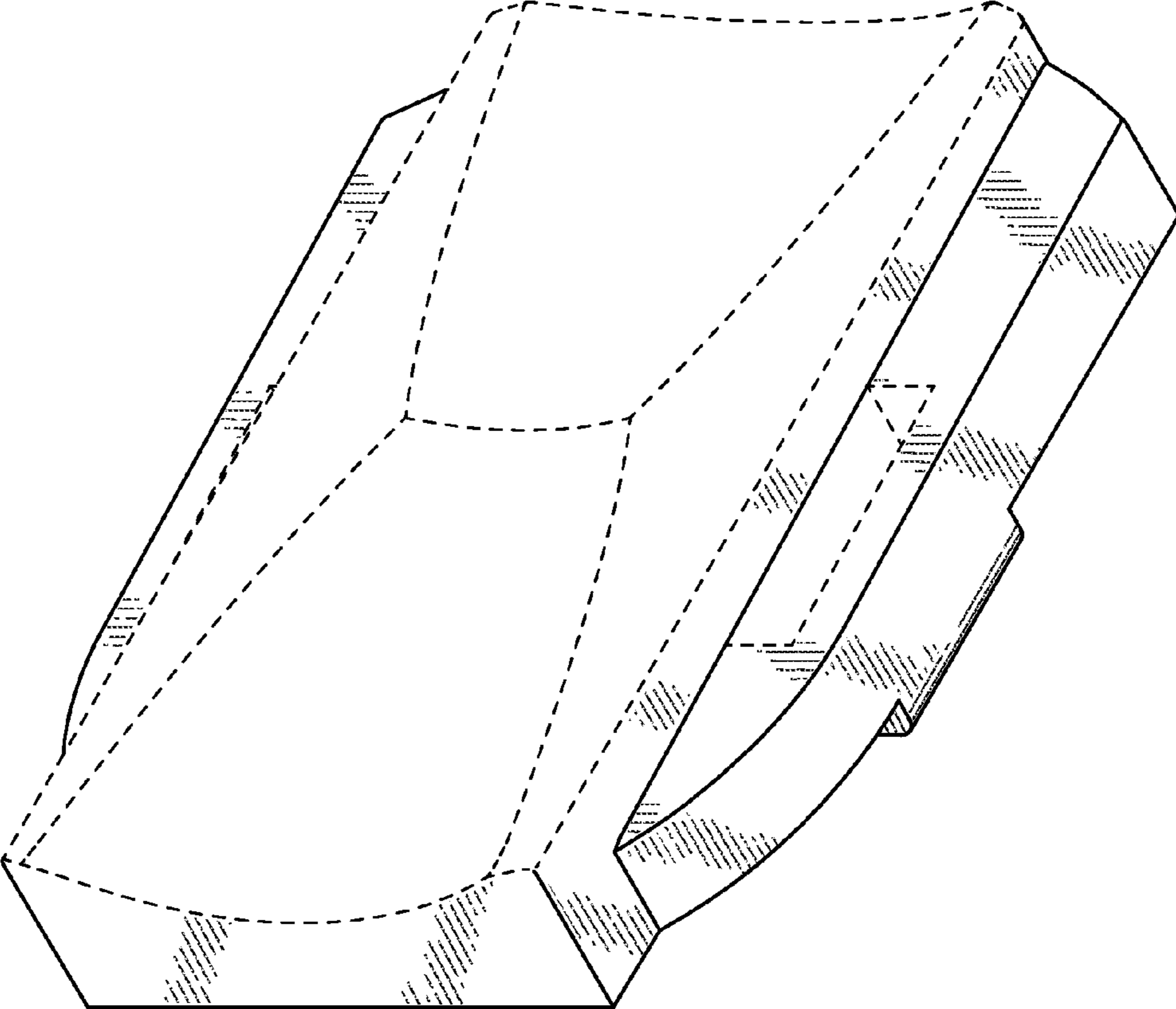

FIG. 1

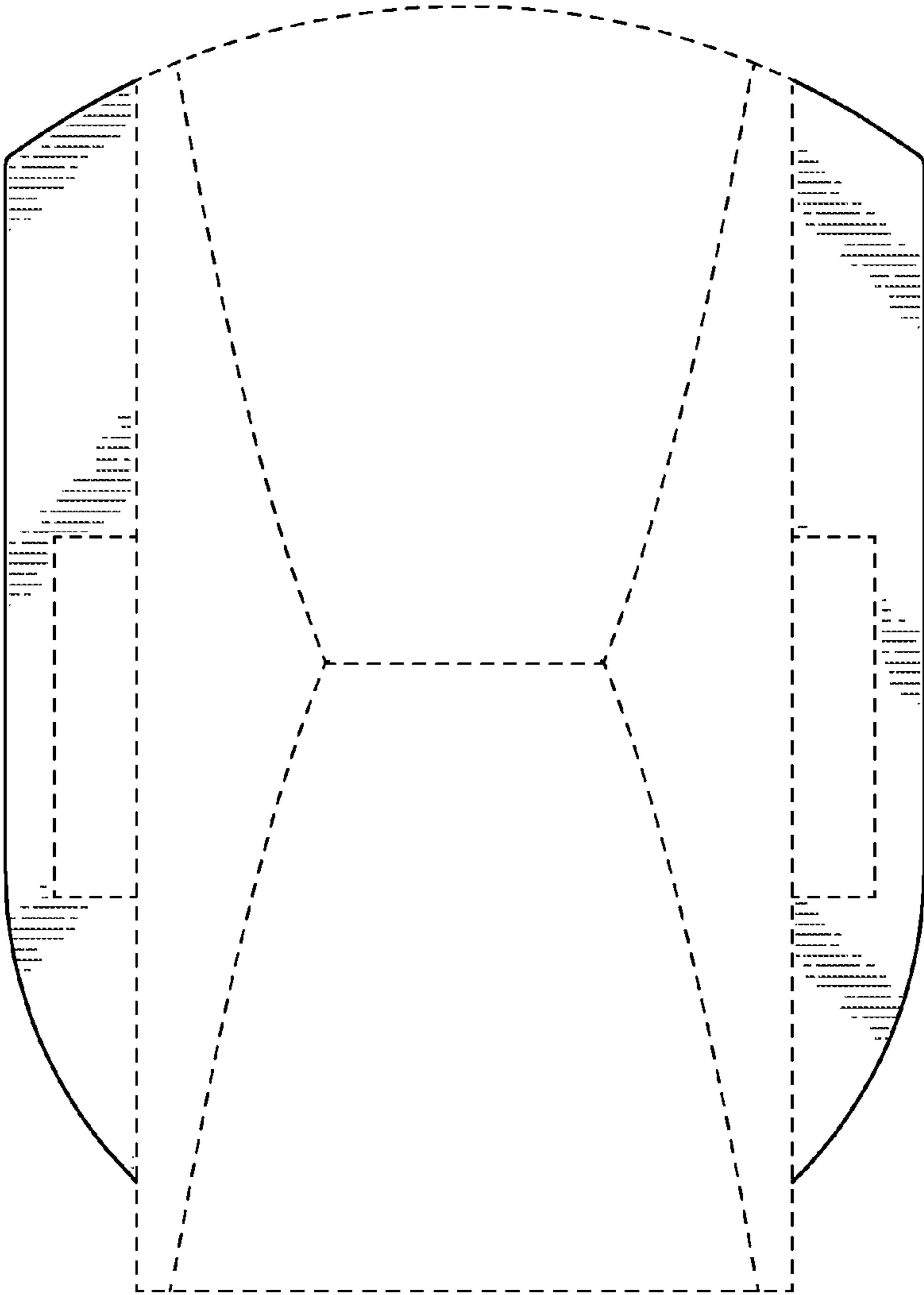

FIG. 2

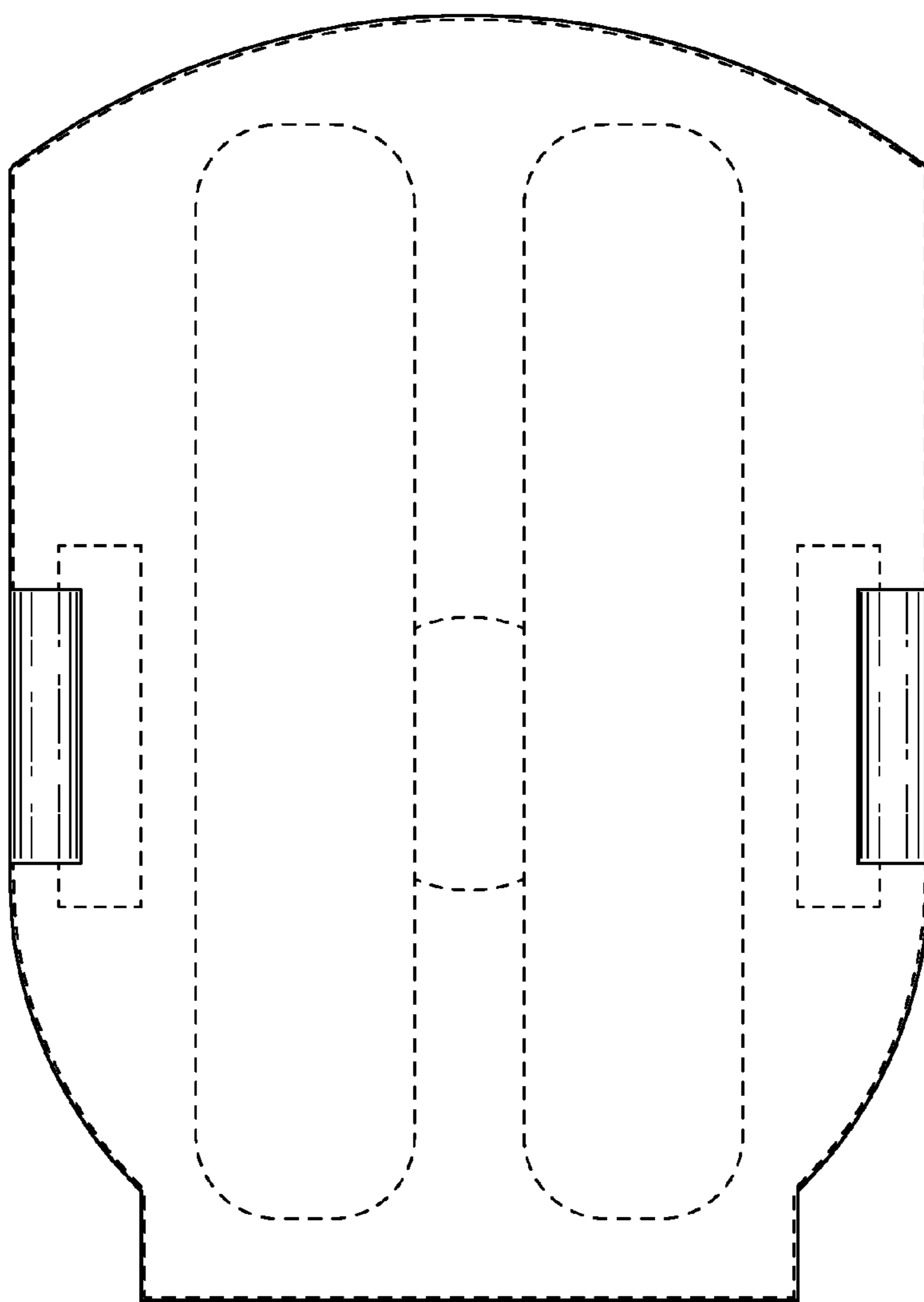

FIG. 3

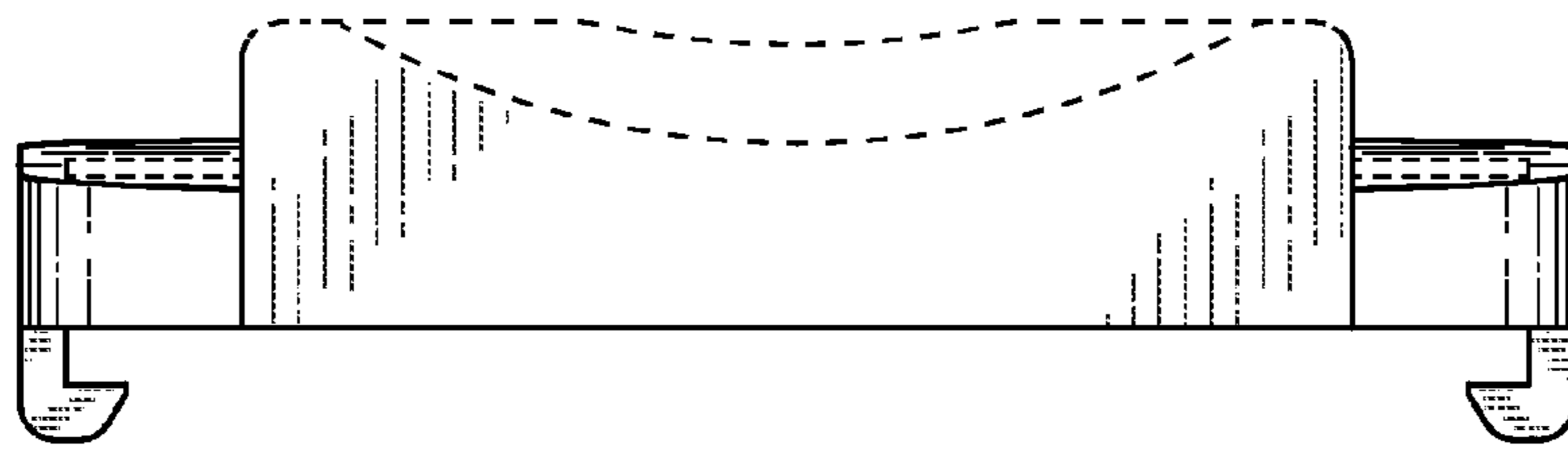

FIG. 4

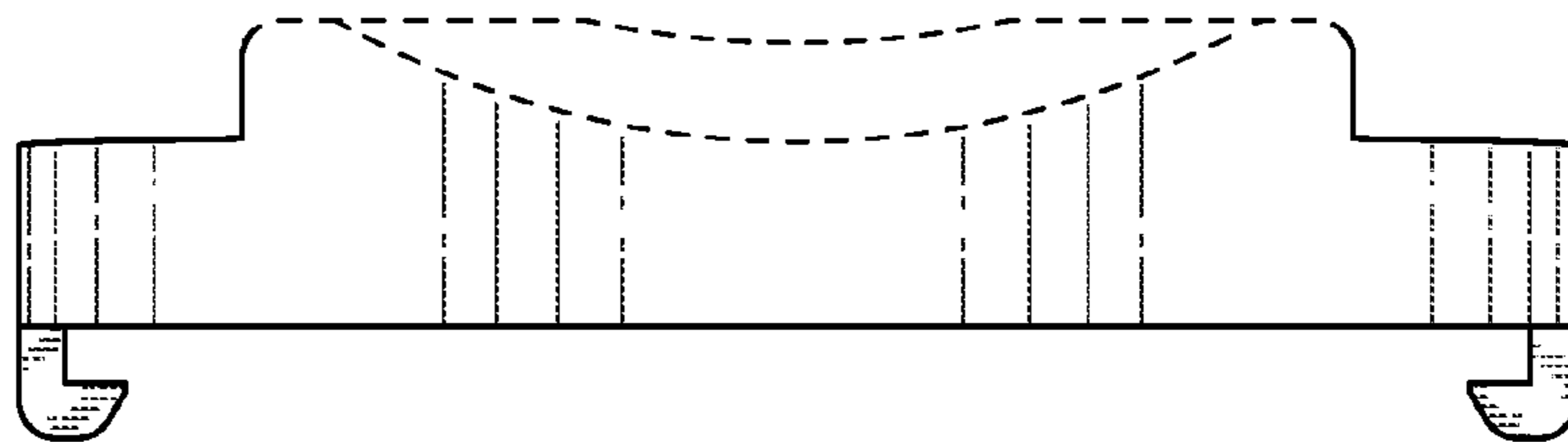

FIG. 5

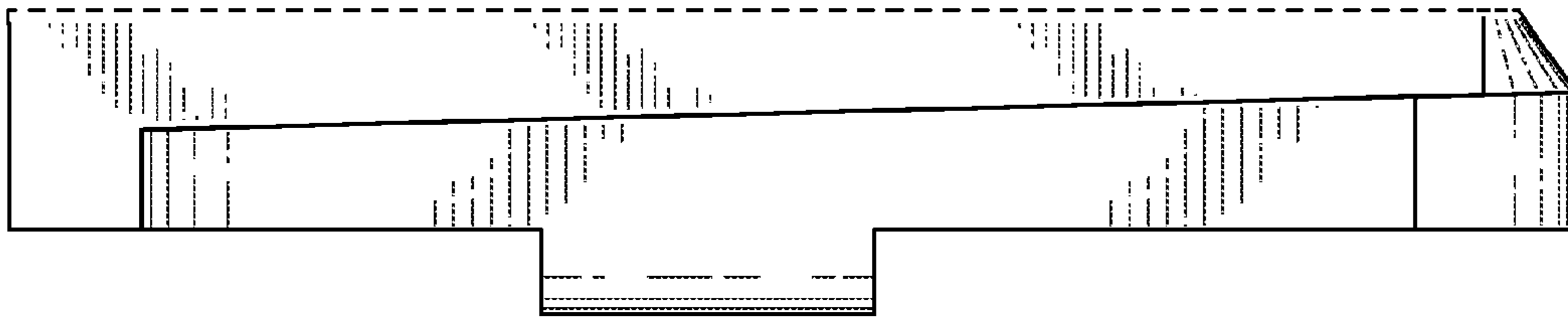

FIG. 6

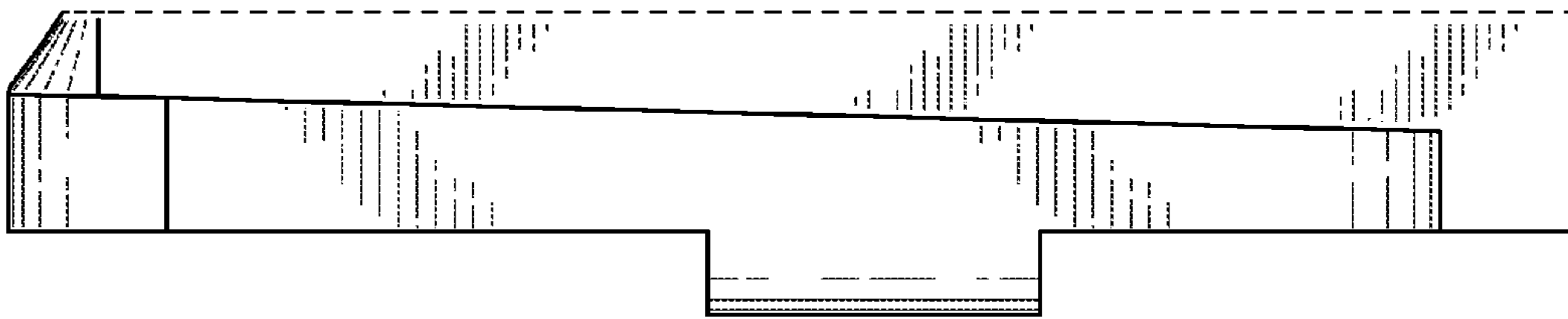

FIG. 7

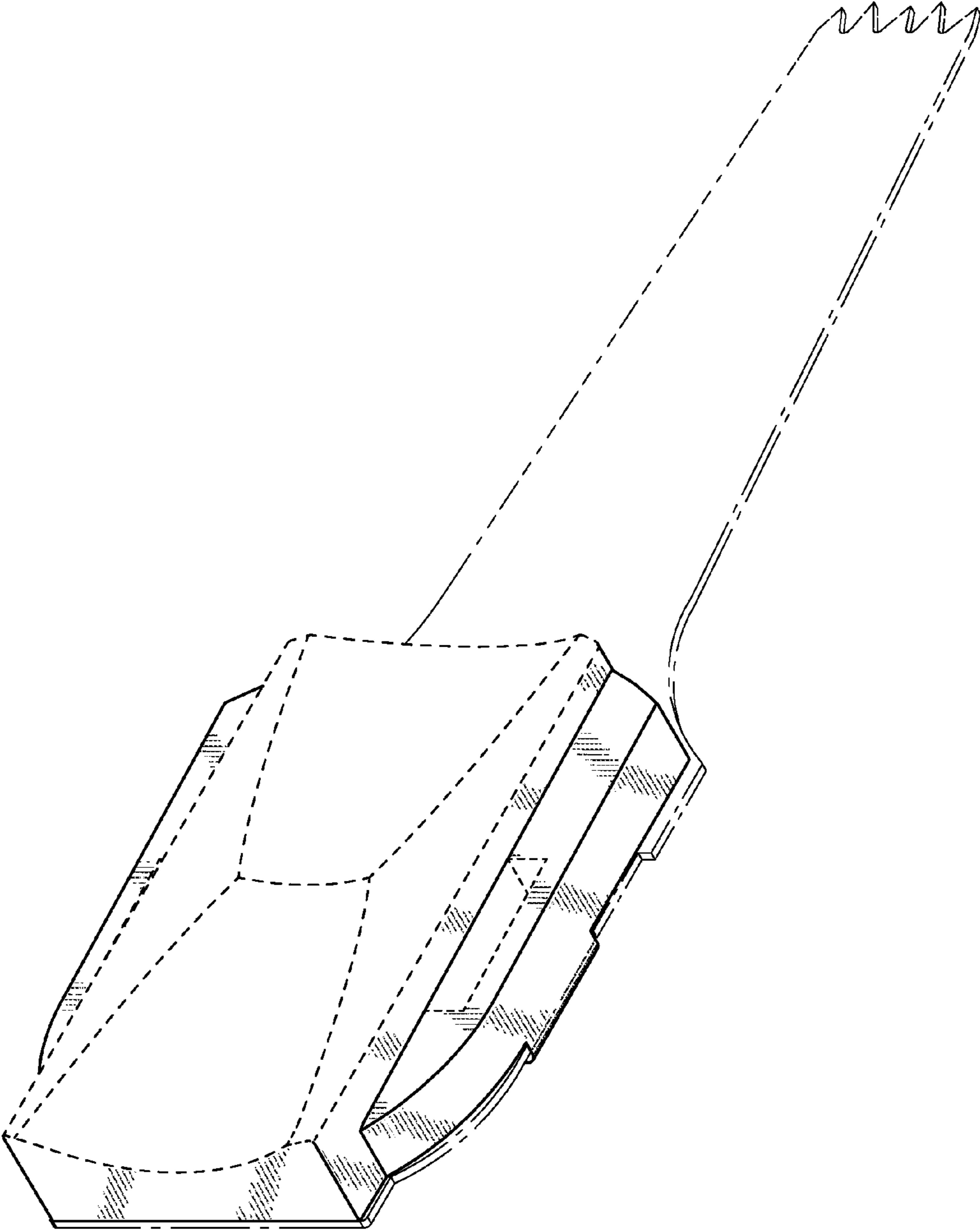

FIG. 8

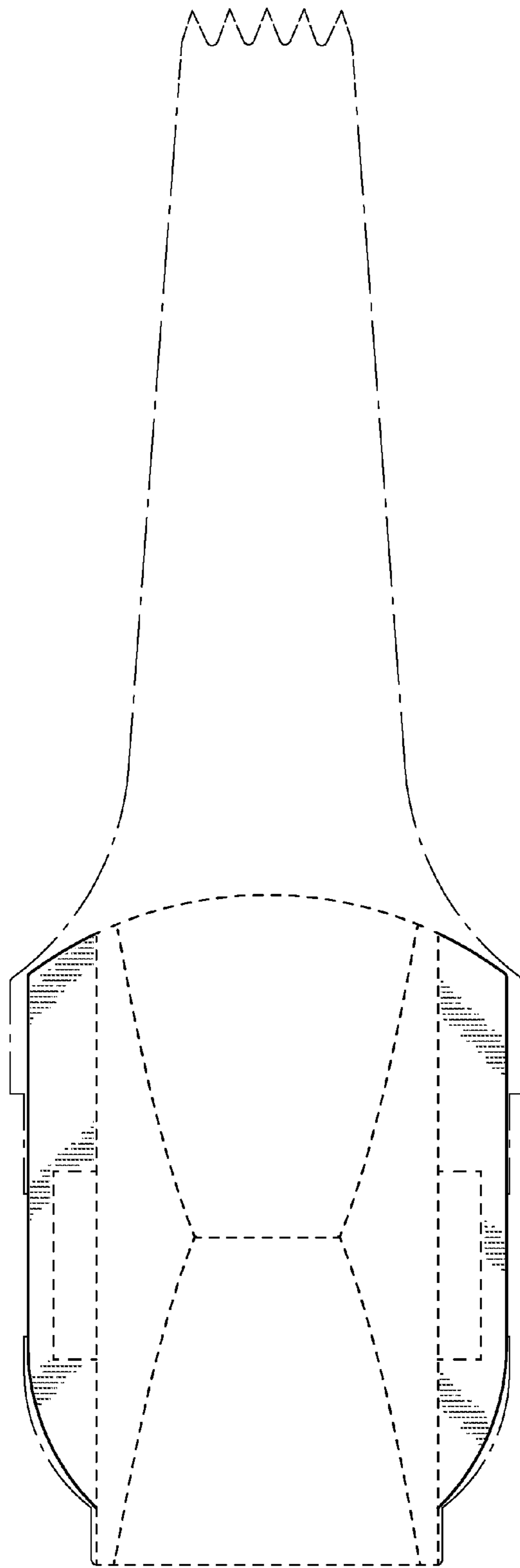

FIG. 9



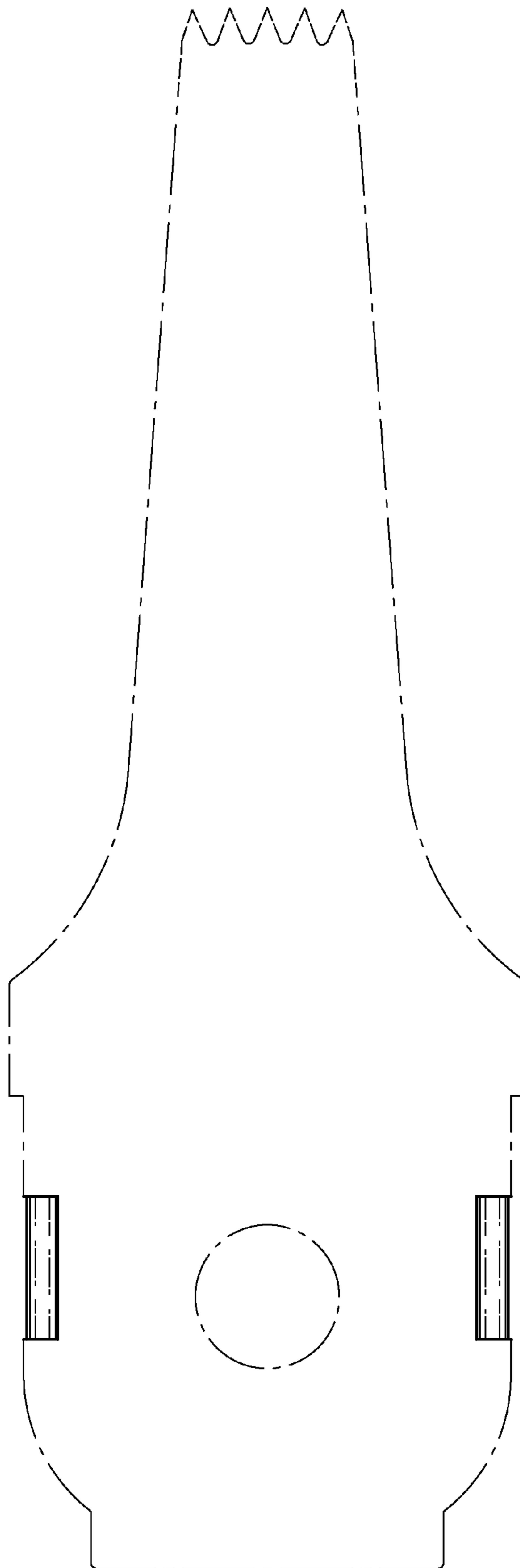

FIG. 10

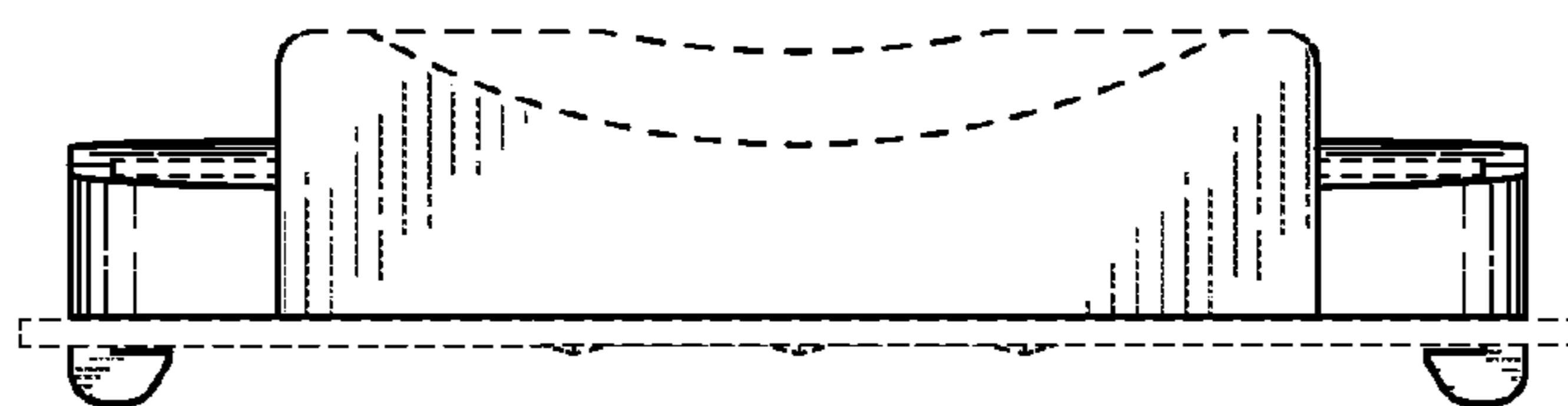

FIG. 11

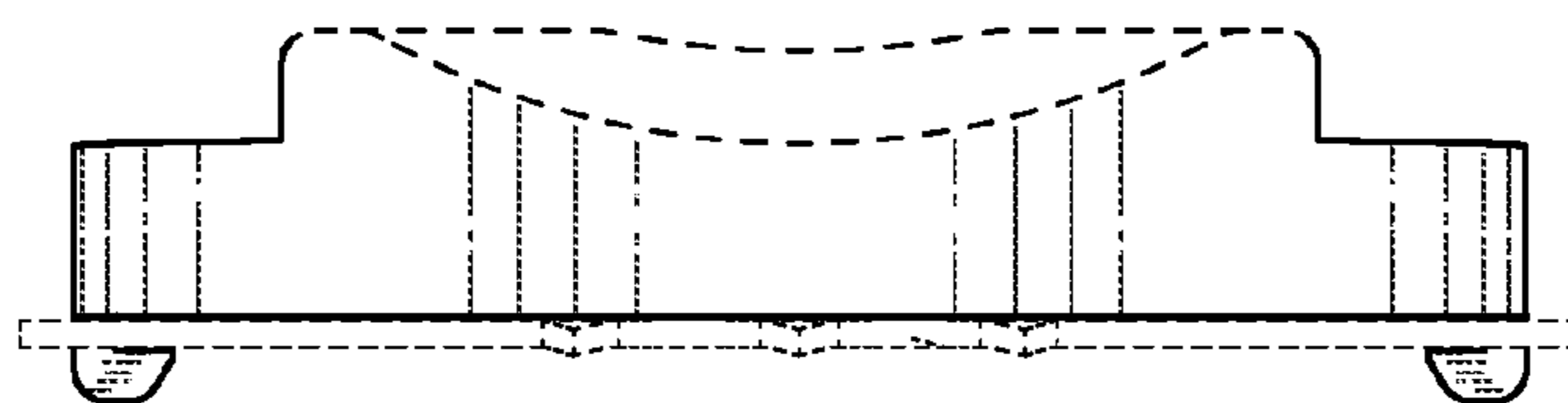

FIG. 12

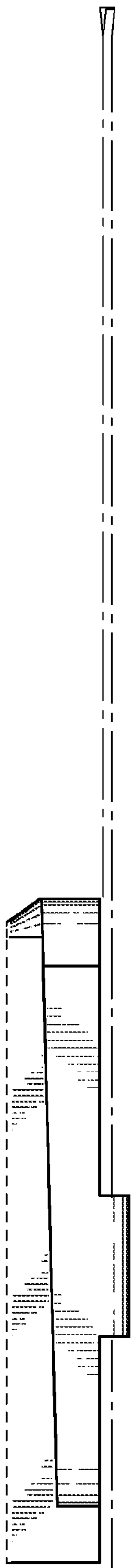

FIG. 13

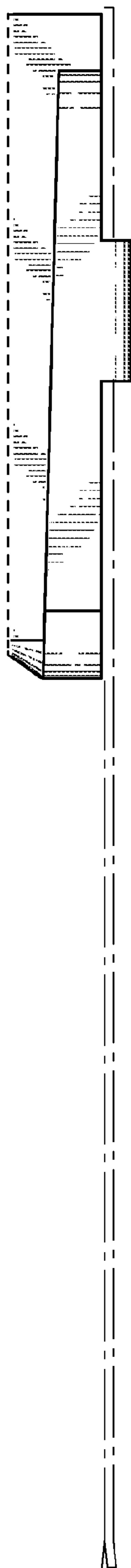

FIG. 14