



US00D660905S

(12) **United States Design Patent**
Lee et al.

(10) **Patent No.:** **US D660,905 S**
(45) **Date of Patent:** **** May 29, 2012**

(54) **PRINTER DEVICE**

(75) Inventors: **Shao Hwa Lee**, Singapore (SG); **Soon Ling Tan**, Singapore (SG); **Wee Hian Khor**, Singapore (SG); **Yaw Horng Yap**, Singapore (SG); **Kian Seng Toh**, Skudai (MY)

(73) Assignee: **Brady Worldwide, Inc.**, Milwaukee, WI (US)

(**) Term: **14 Years**

(21) Appl. No.: **29/398,343**

(22) Filed: **Jul. 29, 2011**

(51) **LOC (9) Cl.** **18-99**

(52) **U.S. Cl.** **D18/19; D18/52**

(58) **Field of Classification Search** D18/14-21,
D18/6-7, 50, 52; D19/68; D14/347, 426;
358/1.1, 1.6, 1.8; 101/111, 288; 156/DIG. 48,
156/0.49

See application file for complete search history.

(56) **References Cited**

U.S. PATENT DOCUMENTS

D232,834 S *	9/1974	Yamagami	D18/7
5,556,213 A	9/1996	Kudo et al.		
D398,629 S *	9/1998	Nakamura et al.	D18/19
D410,674 S *	6/1999	Tanaka et al.	D18/19
6,142,688 A	11/2000	Saito		
D477,629 S *	7/2003	Hattori et al.	D18/19
D565,644 S *	4/2008	Hattori	D18/19
D567,281 S *	4/2008	Hattori	D18/19
7,806,608 B2	10/2010	Saito et al.		
7,893,952 B2 *	2/2011	Bandholz et al.	347/197

FOREIGN PATENT DOCUMENTS

JP	05084995	4/1993
JP	08238821	9/1996
JP	09207417	8/1997
JP	10006570	1/1998

JP	10006593	1/1998
JP	11227276	8/1999
JP	2000254891	9/2000
JP	2000263866	9/2000
JP	2000263868	9/2000
JP	2001277183	10/2001
JP	2002137864	5/2002
JP	2002254385	9/2002
JP	2002254716	9/2002
JP	2002255434	9/2002
JP	2003181791	7/2003
JP	2003251879 A	9/2003
JP	2005134674	5/2005
JP	2005324404	11/2005
JP	2006027238	2/2006
JP	2007111872	5/2007

* cited by examiner

Primary Examiner — Bridget L Eland

(74) *Attorney, Agent, or Firm* — Quarles & Brady LLP

(57) **CLAIM**

The ornamental design for a printer device, as shown and described.

DESCRIPTION

FIG. 1 is a top, left, front perspective view of a printer device embodying our new design;

FIG. 2 is a top, right, back perspective view thereof;

FIG. 3 is a top plan view thereof;

FIG. 4 is a front elevational view thereof;

FIG. 5 is a bottom plan view thereof;

FIG. 6 is a back elevational view thereof;

FIG. 7 is a left elevational view thereof; and,

FIG. 8 is a right elevational view thereof.

The broken lines immediately adjacent the shaded areas represent the bounds of the claimed design while all other broken lines are directed to environment and are for illustrative purposes only; the broken lines form no part of the claimed design.

1 Claim, 4 Drawing Sheets

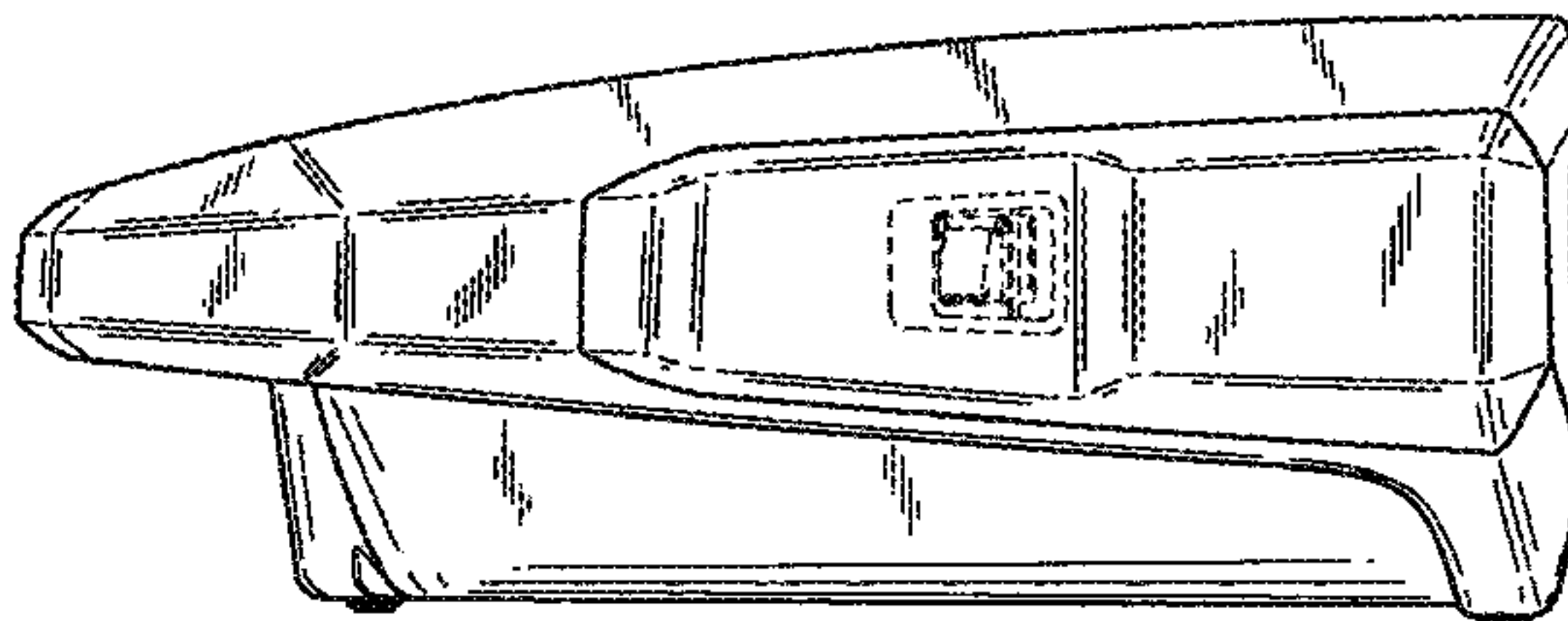
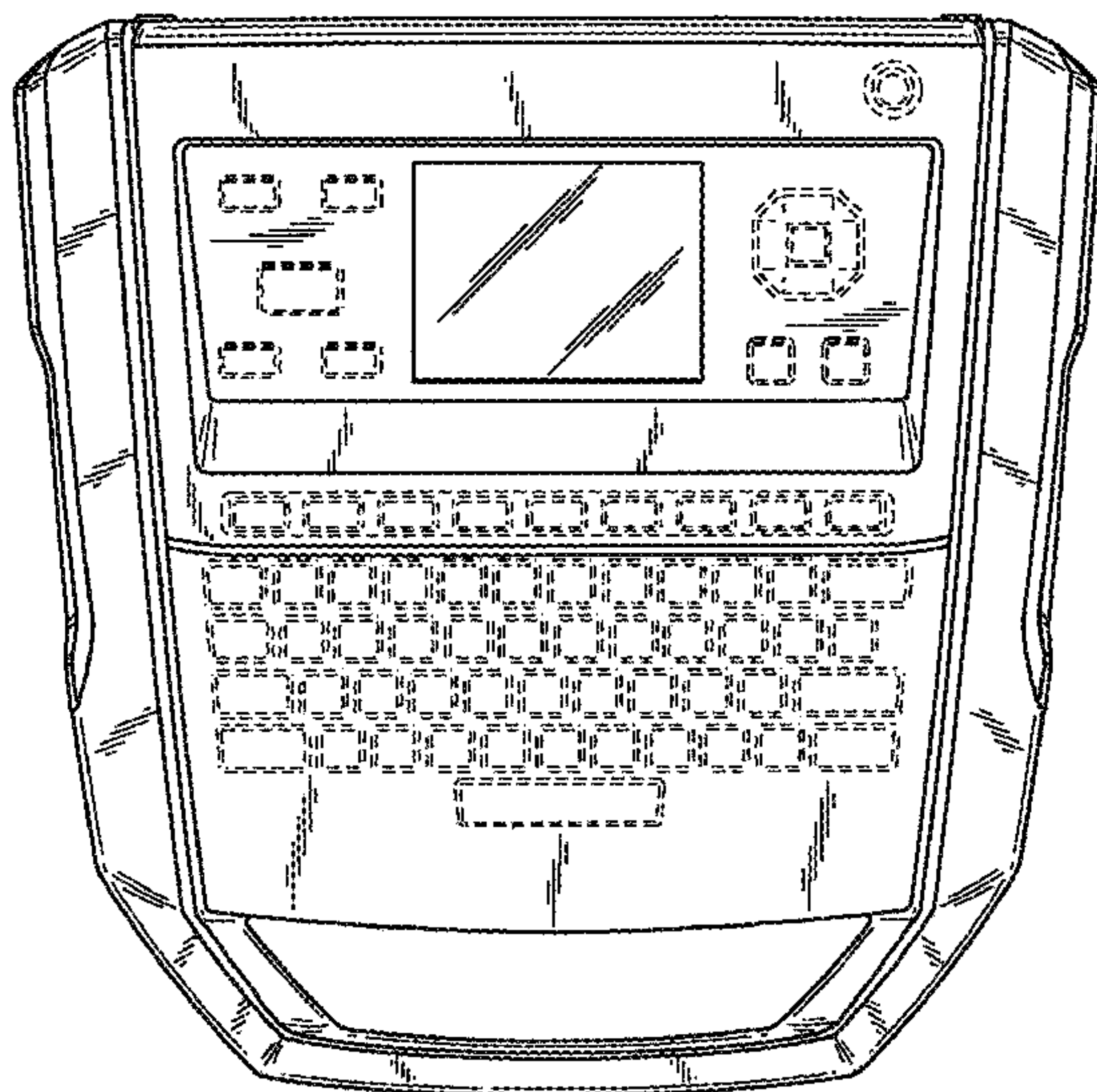

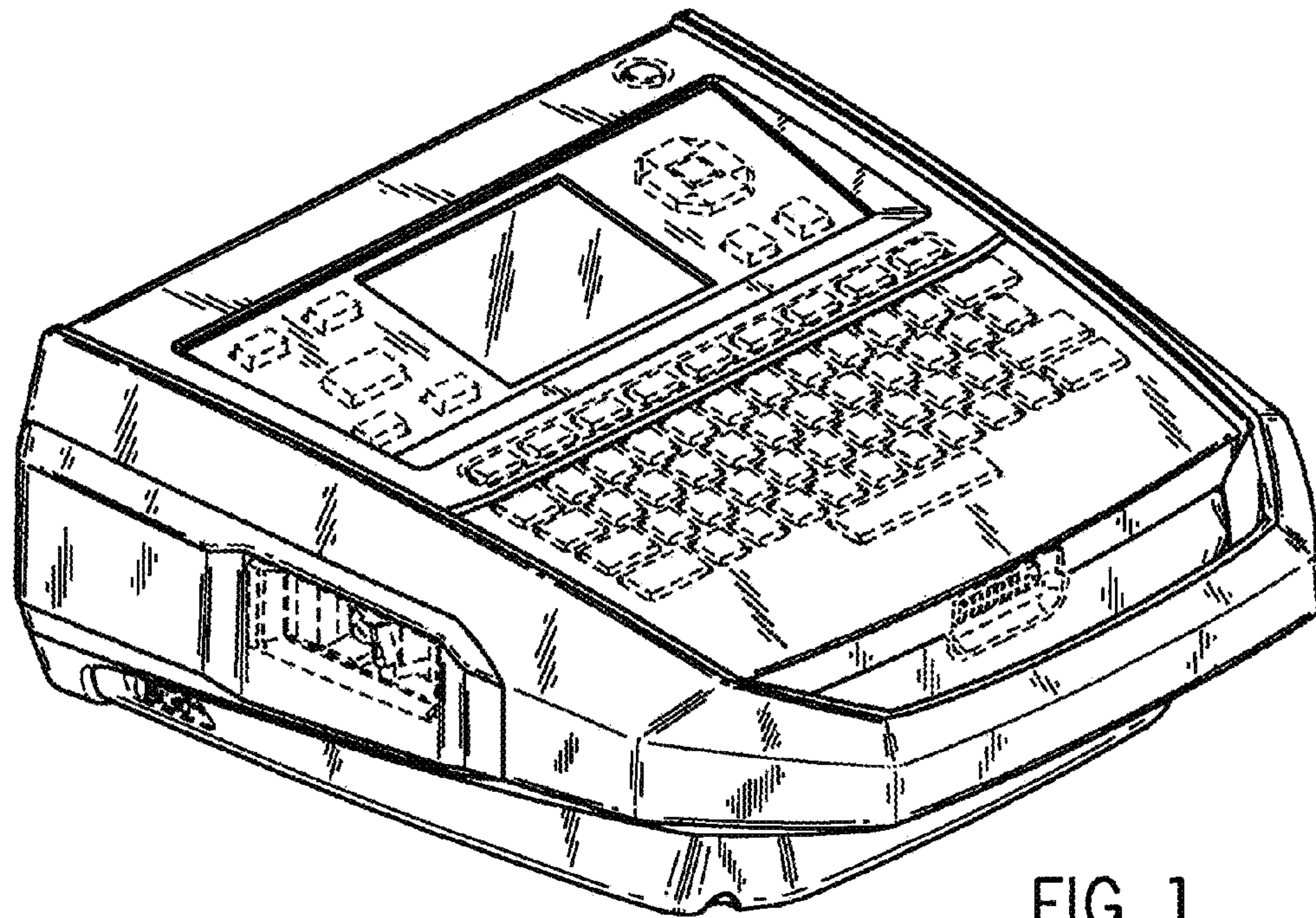

FIG. 1

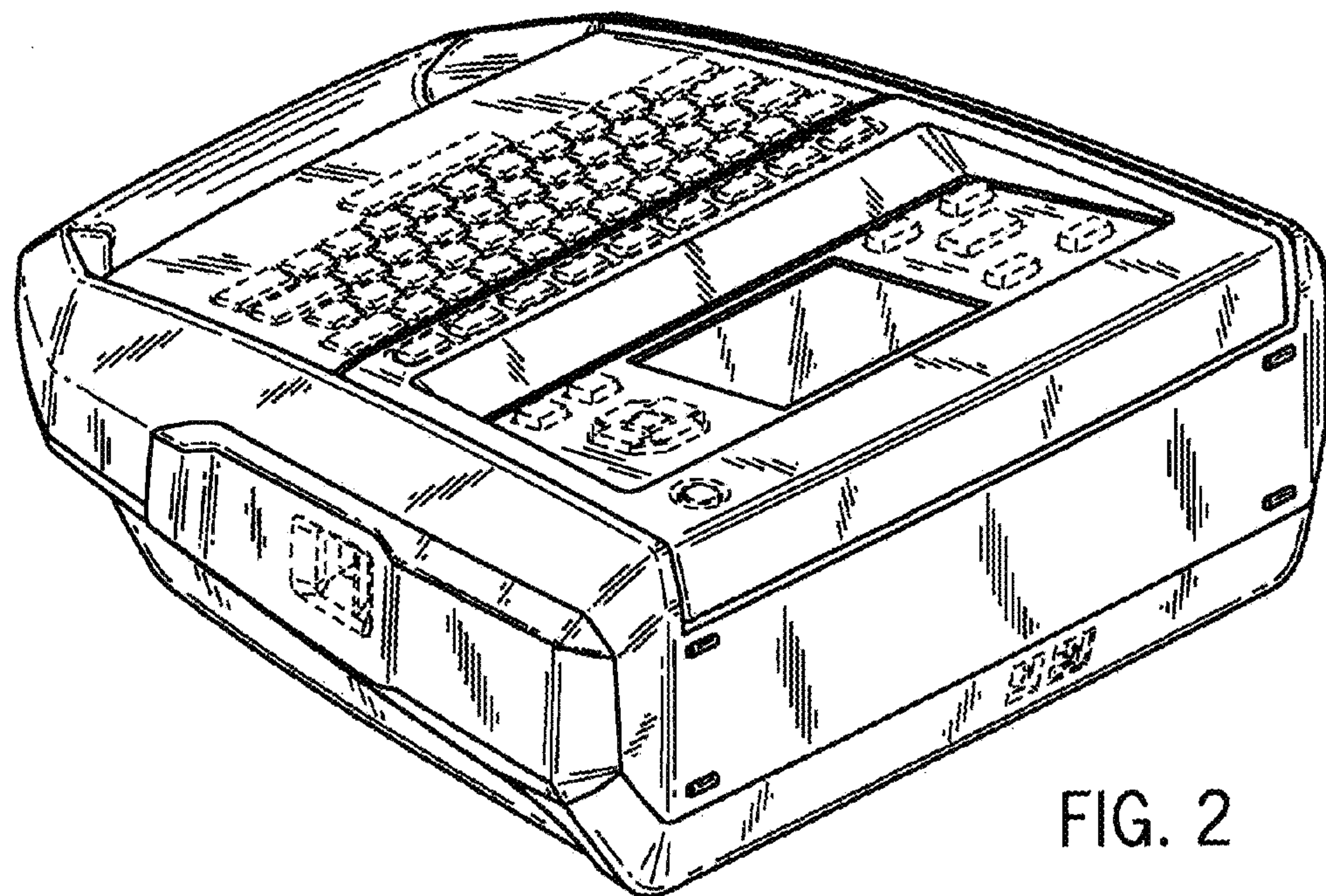

FIG. 2

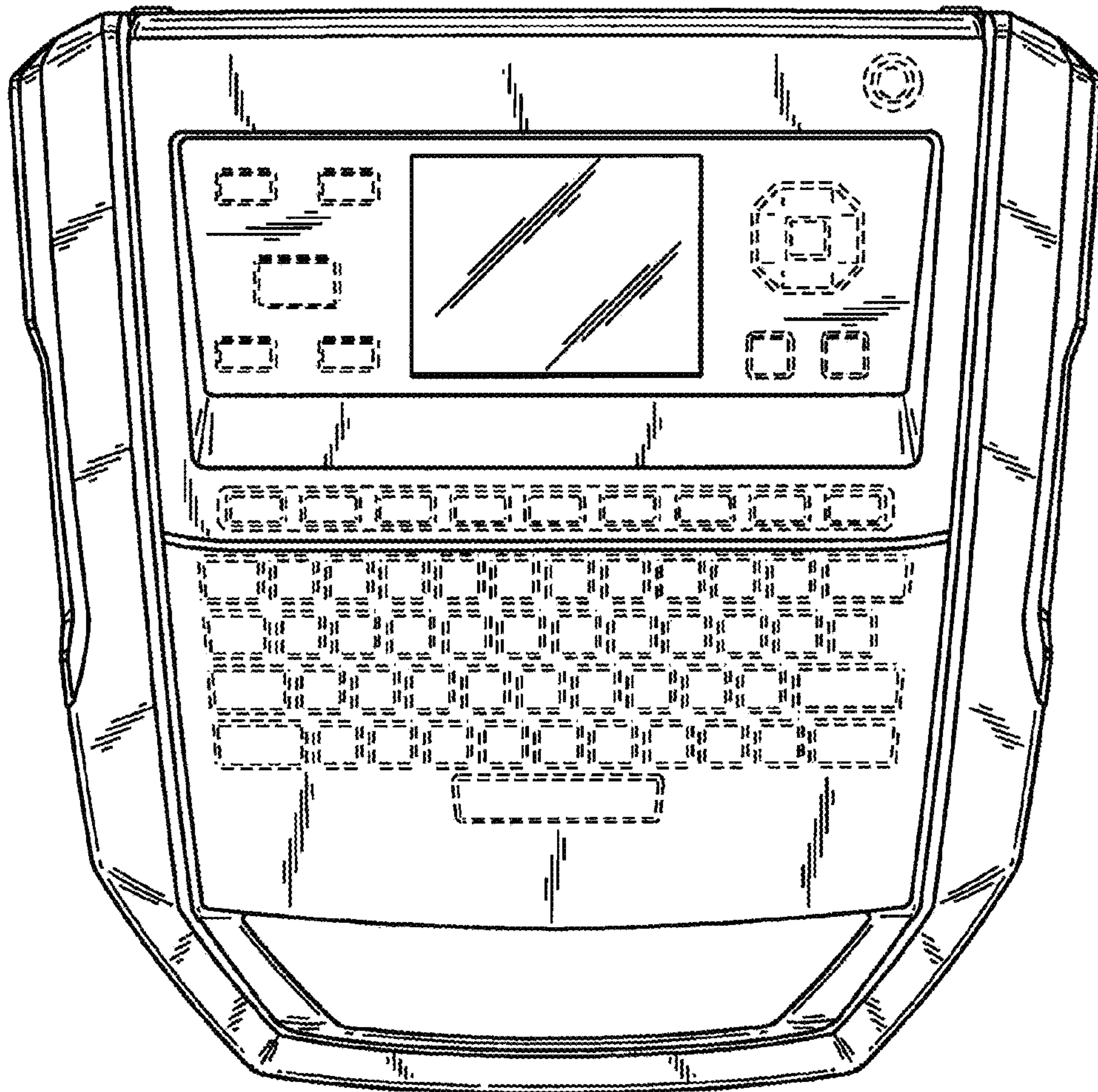

FIG. 3

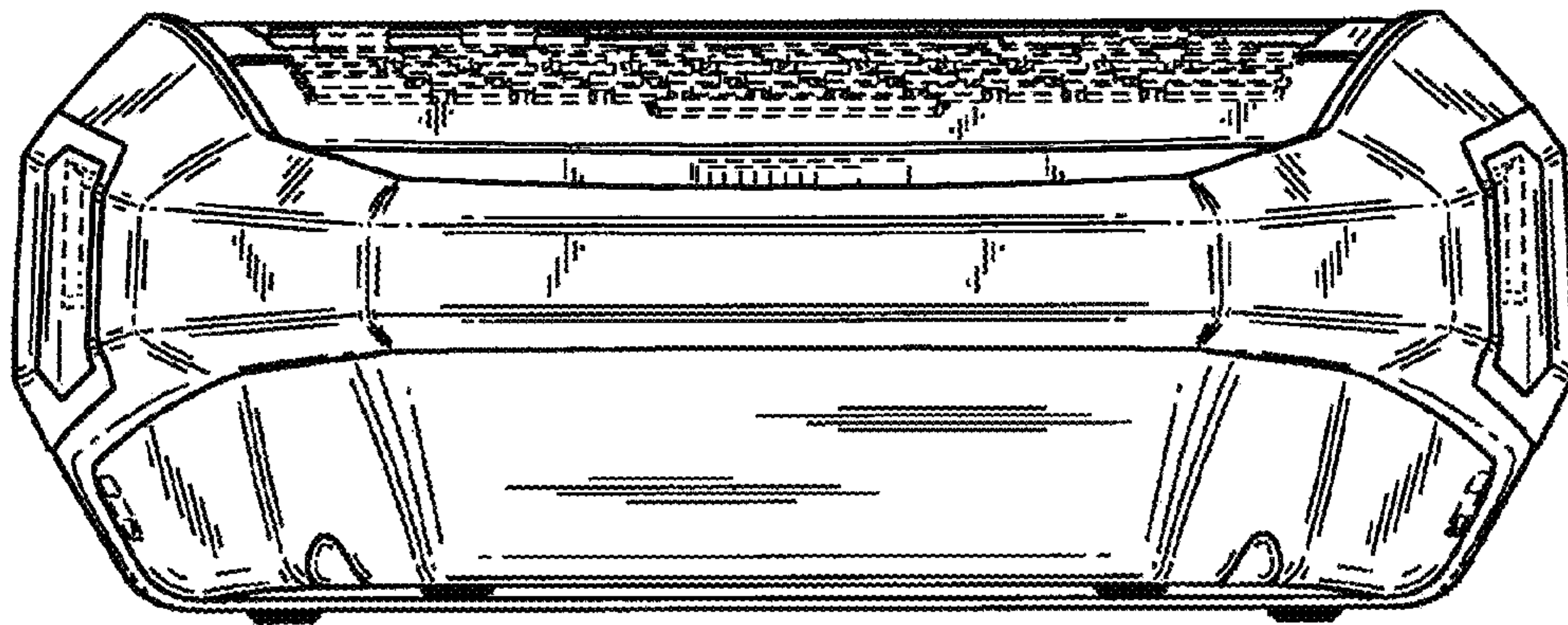

FIG. 4

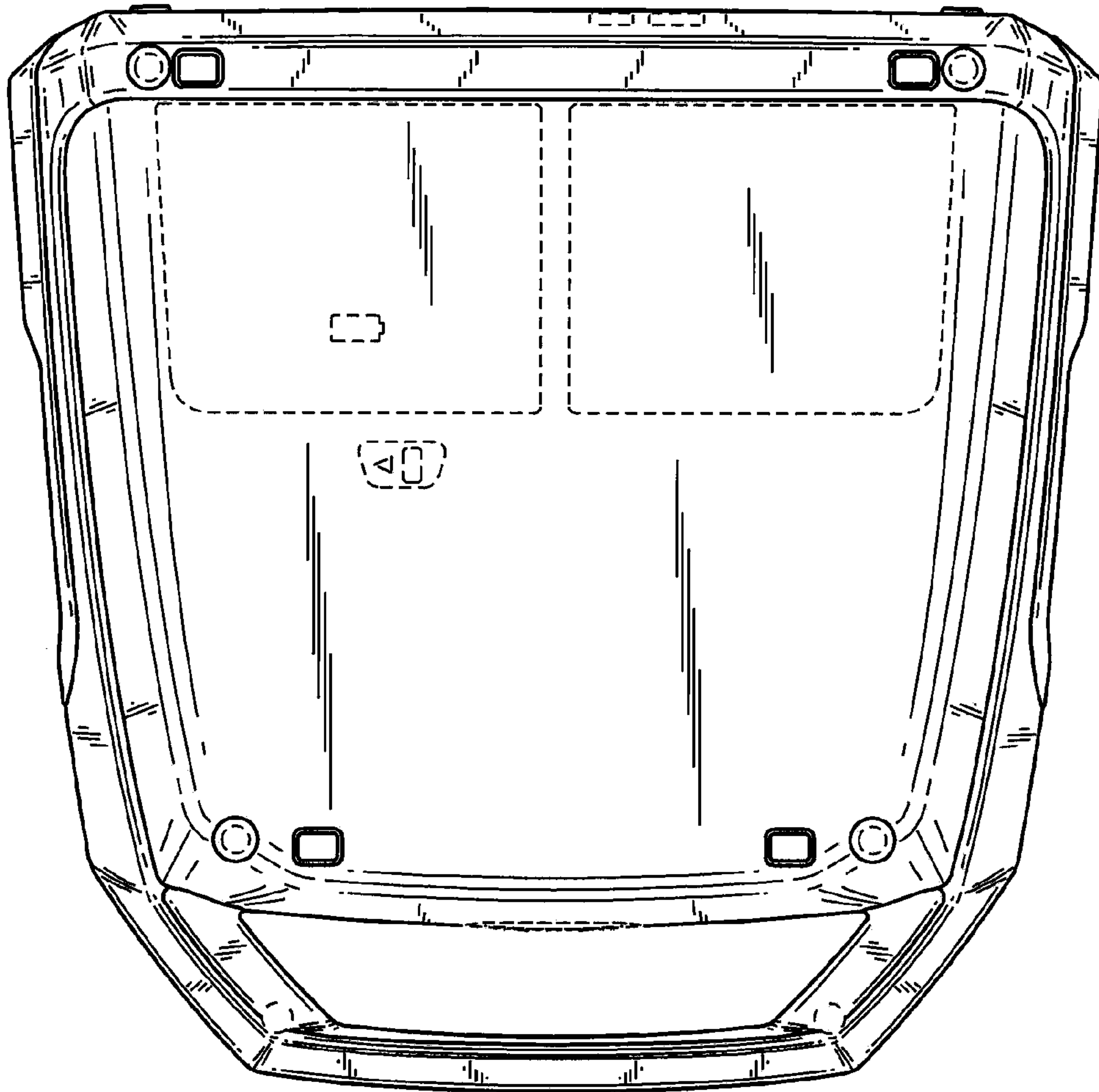

FIG. 5

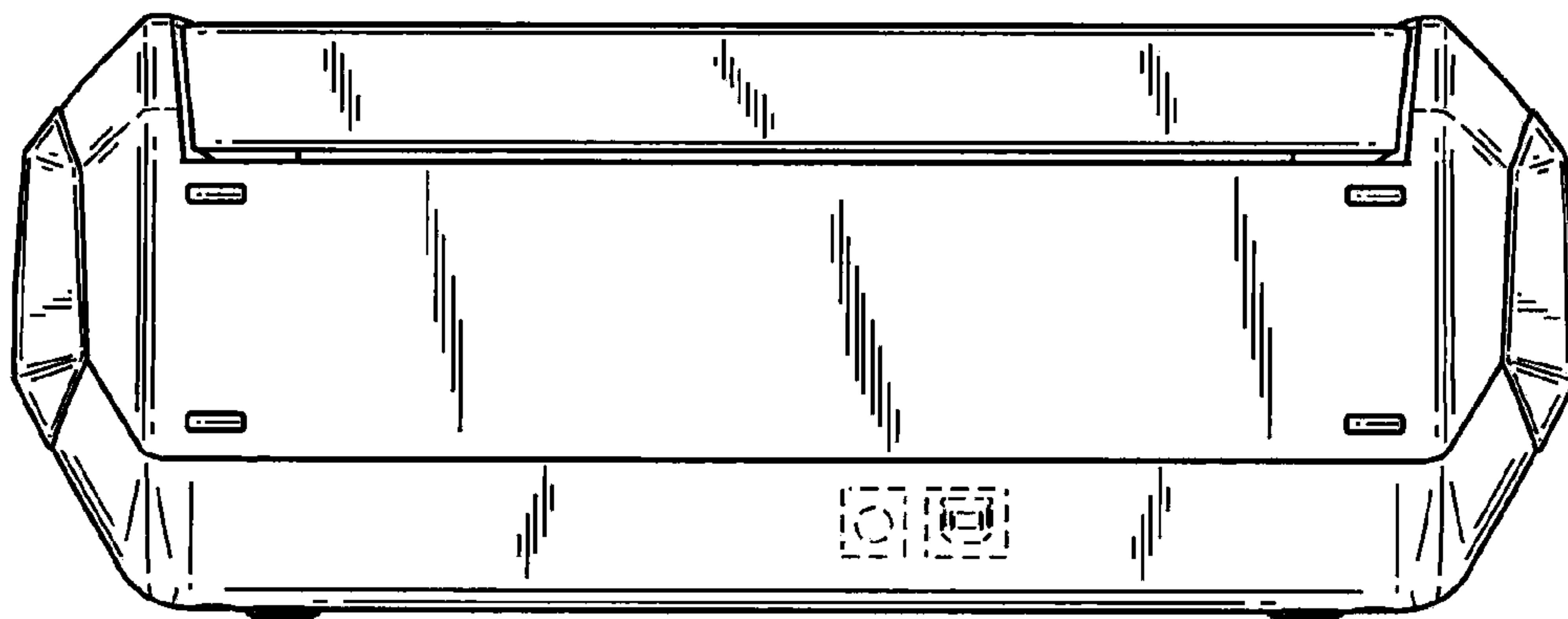

FIG. 6

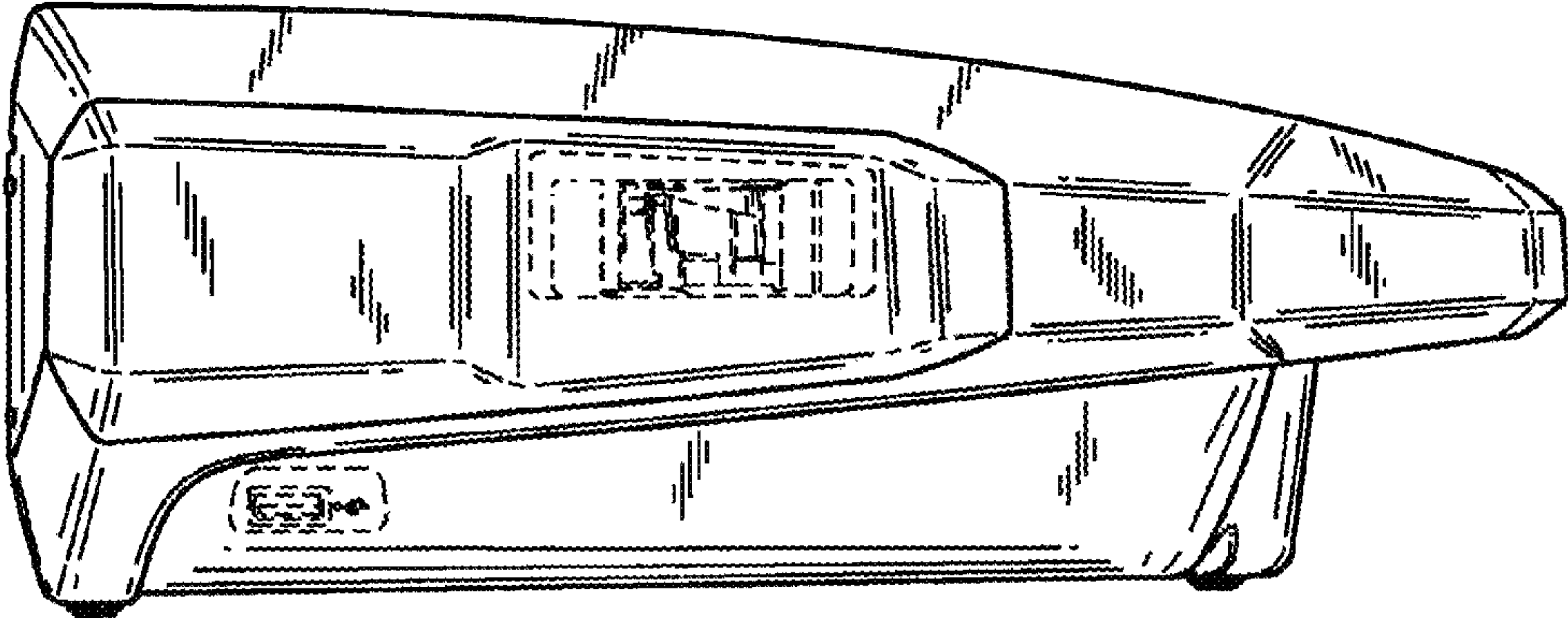

FIG. 7

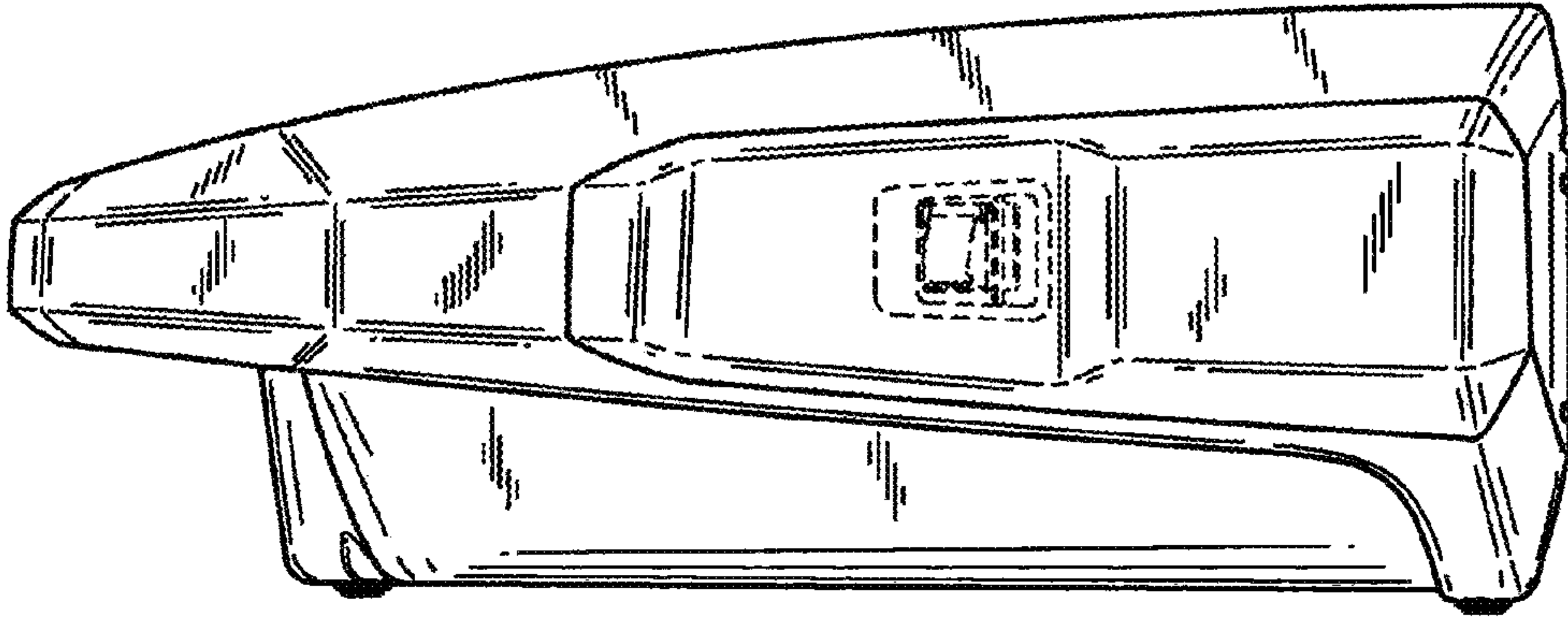

FIG. 8