

US00D660838S

(12) **United States Design Patent**  
**Loken et al.**

(10) **Patent No.:** **US D660,838 S**  
(45) **Date of Patent:** **\*\* May 29, 2012**

(54) **HANDHELD ELECTRONIC DEVICE**

(75) Inventors: **Cameron Mark Loken**, Calgary (CA);  
**Peter Shivkumar**, Almonte (CA); **Paul Anthony Auger**, Osgoode (CA);  
**Kimberly Tee**, Calgary (CA); **Daniel Michael Greenblatt**, Calgary (CA)

(73) Assignee: **SMART Technologies ULC**, Calgary, Alberta (CA)

(\*\*) Term: **14 Years**

(21) Appl. No.: **29/365,491**

(22) Filed: **Jul. 9, 2010**

(51) **LOC (9) Cl.** ..... **14-02**

(52) **U.S. Cl.** ..... **D14/346**

(58) **Field of Classification Search** ..... D14/342-347,  
D14/496, 137, 203.1, 203.3, 203.4, 203.5,  
D14/203.6, 203.7, 203.9, 238.1, 247, 248,  
D14/138 R, 138 AA, 138 AB, 138 AC, 138 AD,  
D14/138 C, 138 G; 345/901, 905; 379/433.13,  
379/433.12, 916, 433.04, 433.07, 433.11;  
455/556.1, 556.2, 566, 575.1, 575.3, 575.4,  
455/90.3

See application file for complete search history.

(56) **References Cited**

**U.S. PATENT DOCUMENTS**

D359,753 S \* 6/1995 Salinas et al. .... D18/19  
D367,043 S \* 2/1996 Ross et al. .... D14/346  
D380,201 S \* 6/1997 Ross et al. .... D14/346  
D551,665 S \* 9/2007 Tom et al. .... D14/346  
7,495,895 B2 \* 2/2009 Carnevali ..... 361/679.26  
D595,290 S \* 6/2009 Takemasa ..... D14/346

D595,291 S \* 6/2009 Takemasa ..... D14/346  
D602,933 S \* 10/2009 Huang et al. .... D14/346  
D604,299 S \* 11/2009 Acevedo ..... D14/346  
D614,618 S \* 4/2010 Morabito ..... D14/346  
D620,909 S \* 8/2010 Lee et al. .... D14/138 AD

\* cited by examiner

*Primary Examiner* — Angela J Lee

(74) *Attorney, Agent, or Firm* — Katten Muchin Rosenman LLP

(57) **CLAIM**

The ornamental design for a handheld electronic device, as shown and described.

**DESCRIPTION**

FIG. 1 is a rear elevational view of a handheld electronic device in accordance with our new design;  
FIG. 2 is a front elevational view of the handheld electronic device of FIG. 1;  
FIG. 3 is a perspective view of the handheld electronic device of FIG. 1;  
FIG. 4 is a right side elevational view of the handheld electronic device of FIG. 1;  
FIG. 5 is a left side elevational view of the handheld electronic device of FIG. 1;  
FIG. 6 is a bottom plan view of the handheld electronic device of FIG. 1; and,  
FIG. 7 is top plan view of the handheld electronic device of FIG. 1.

The portions of the handheld electronic device shown in broken lines form no part of the claimed design. The broken line rectangles shown on the rear of the device are unclaimed lines.

**1 Claim, 5 Drawing Sheets**

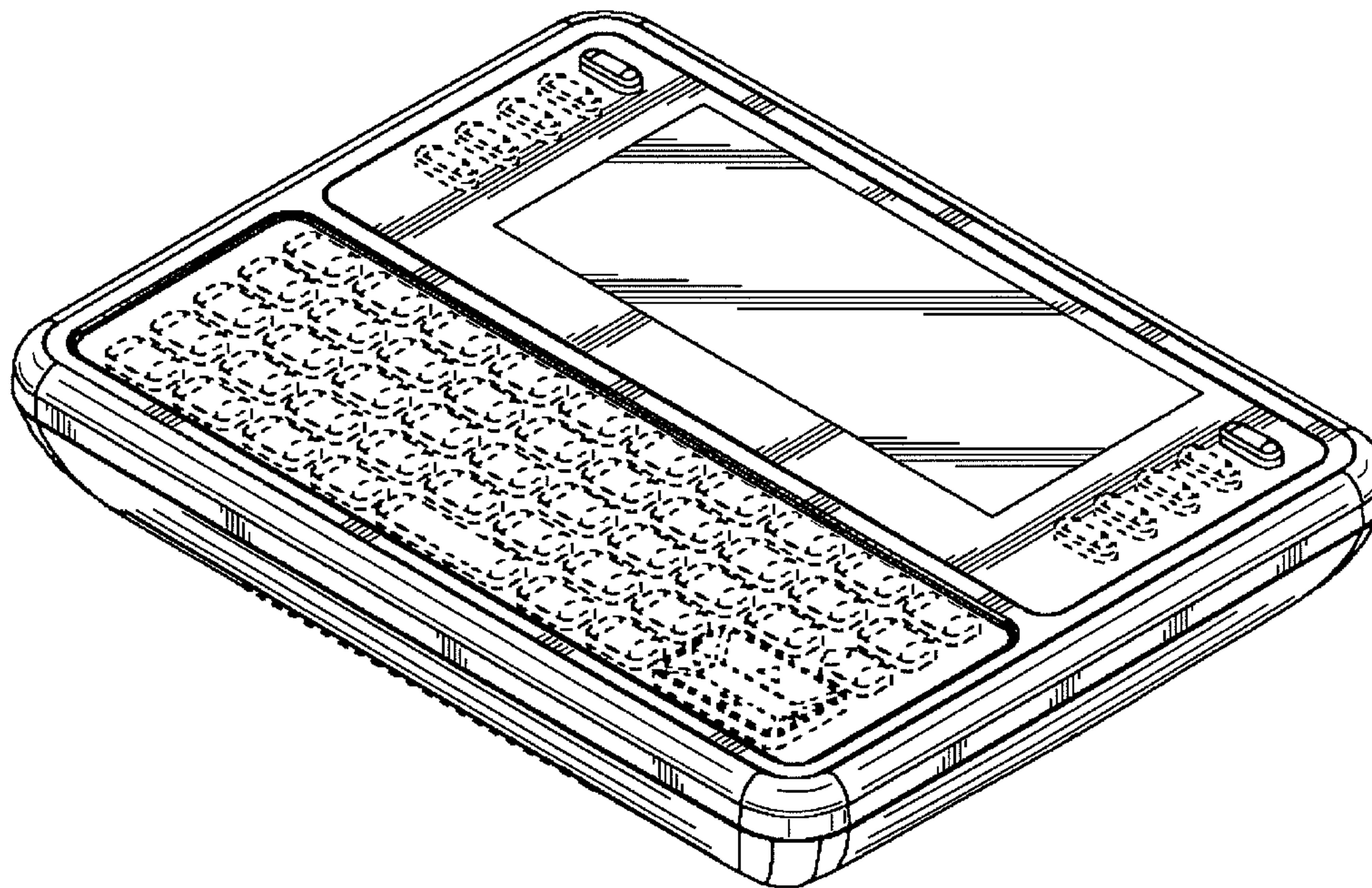

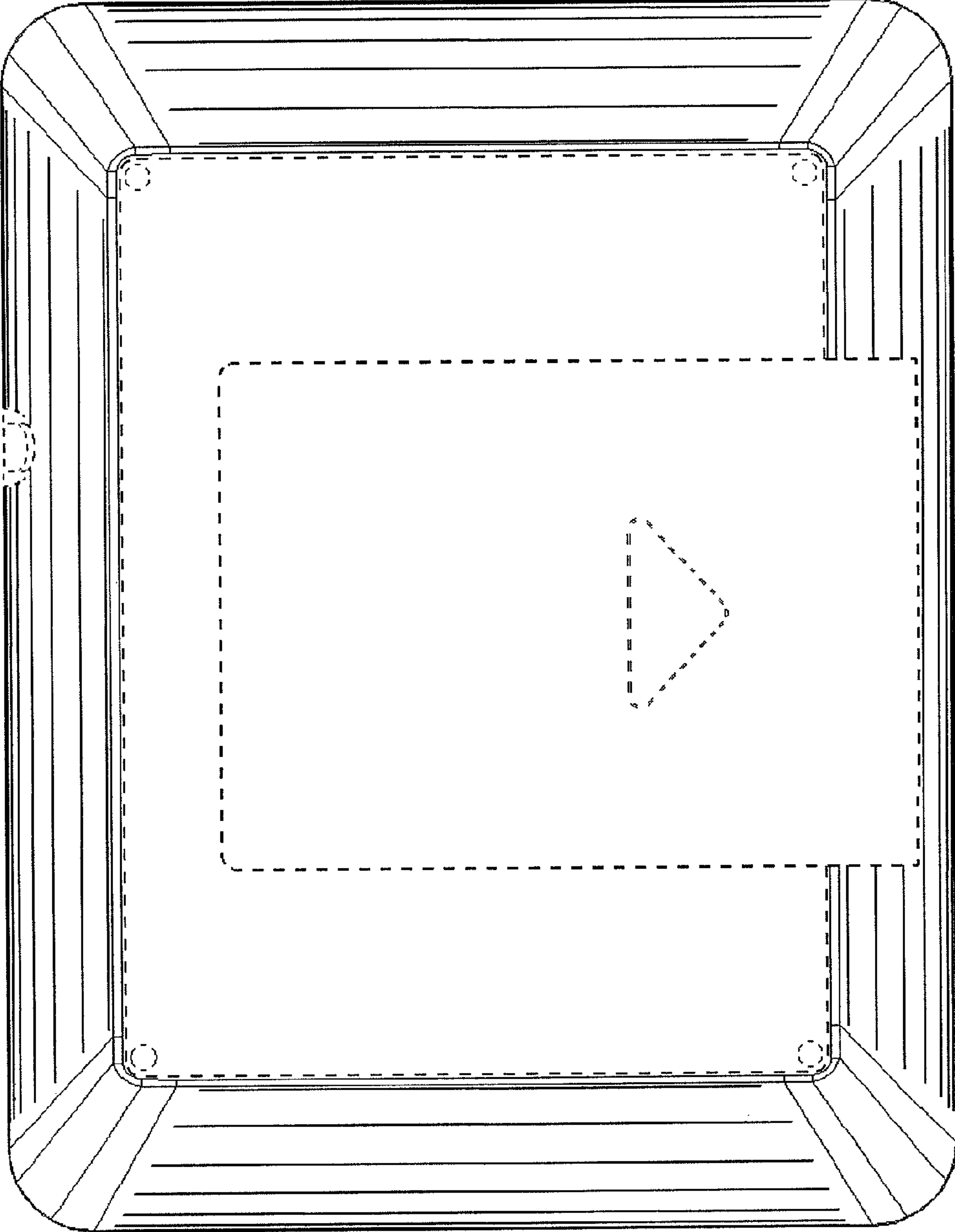

FIG. 1

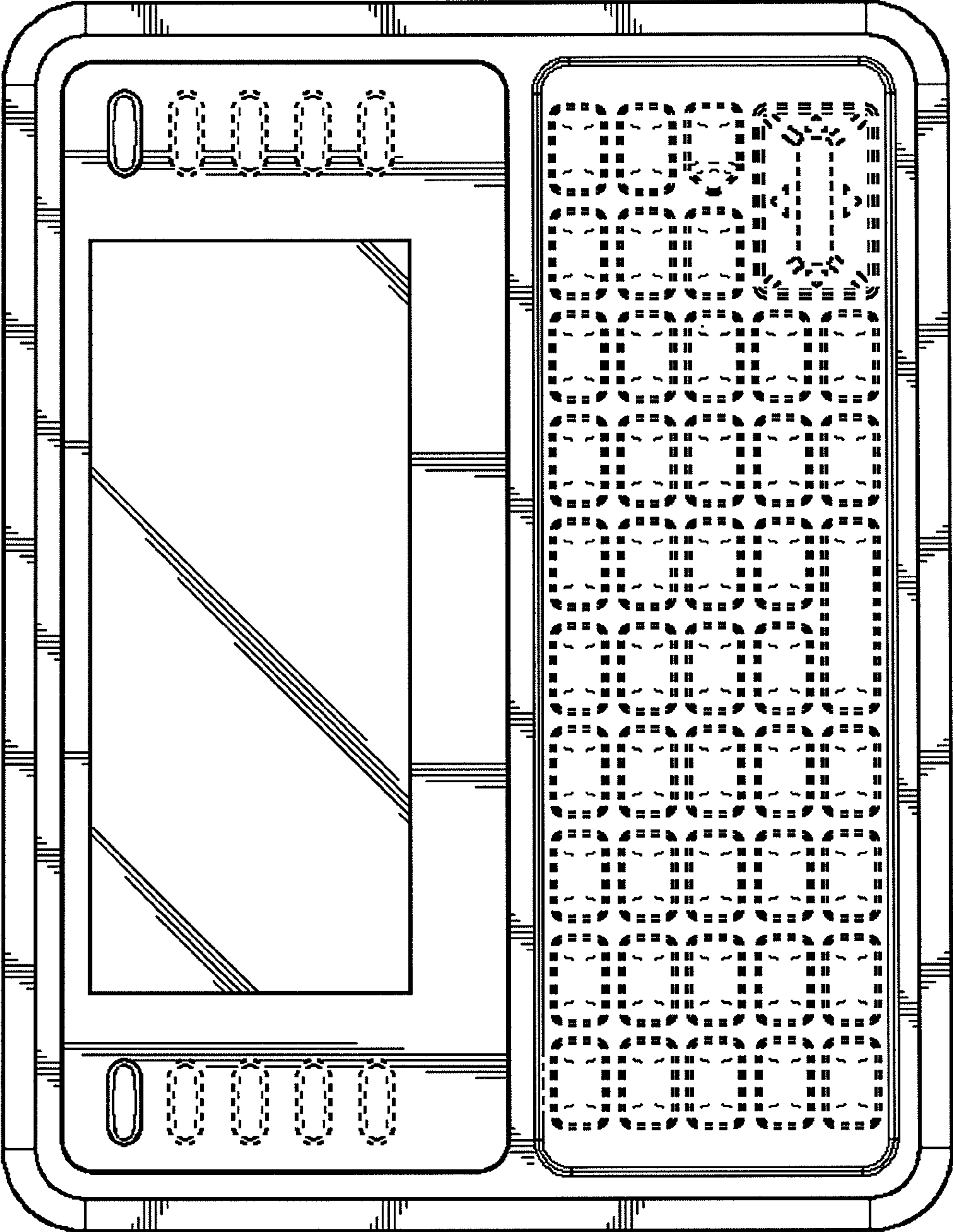

FIG. 2



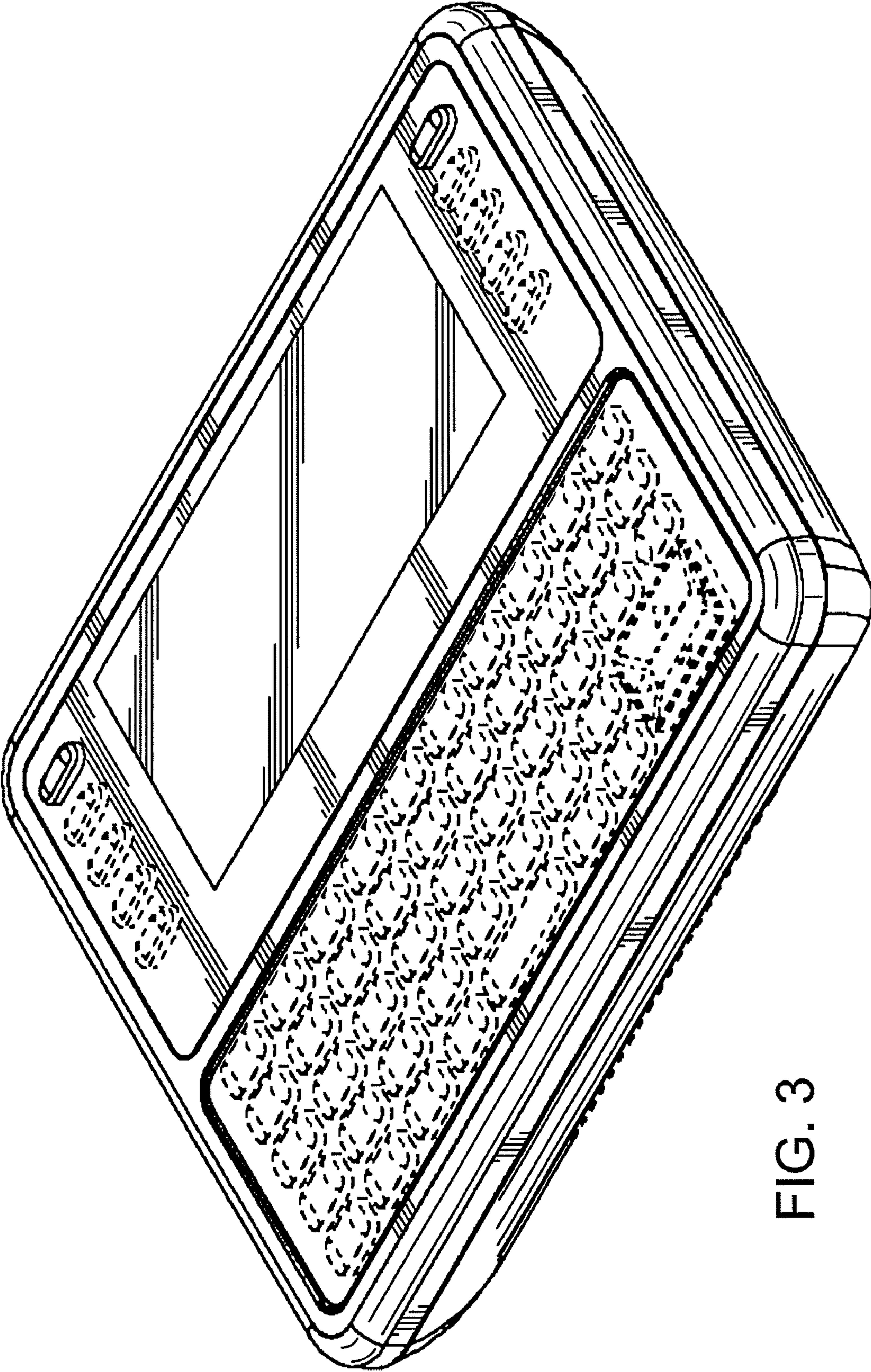

FIG. 3

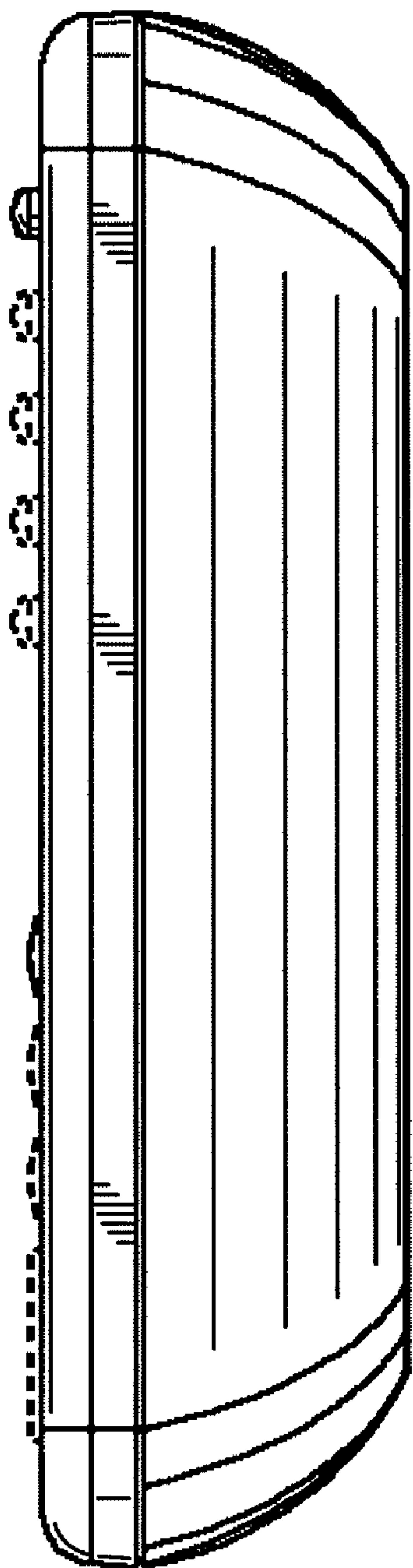

FIG. 4

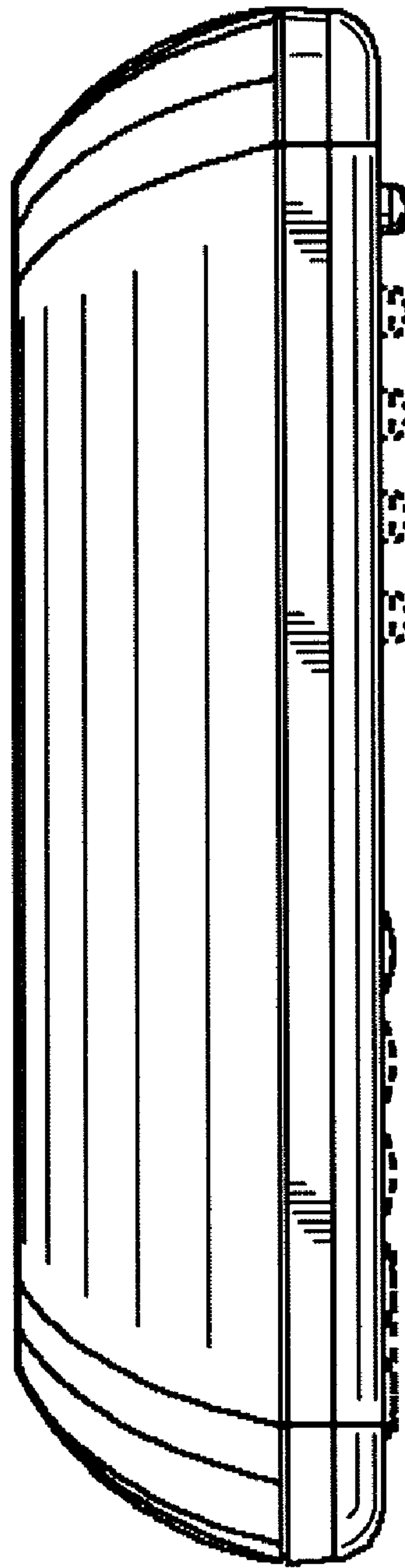

FIG. 5

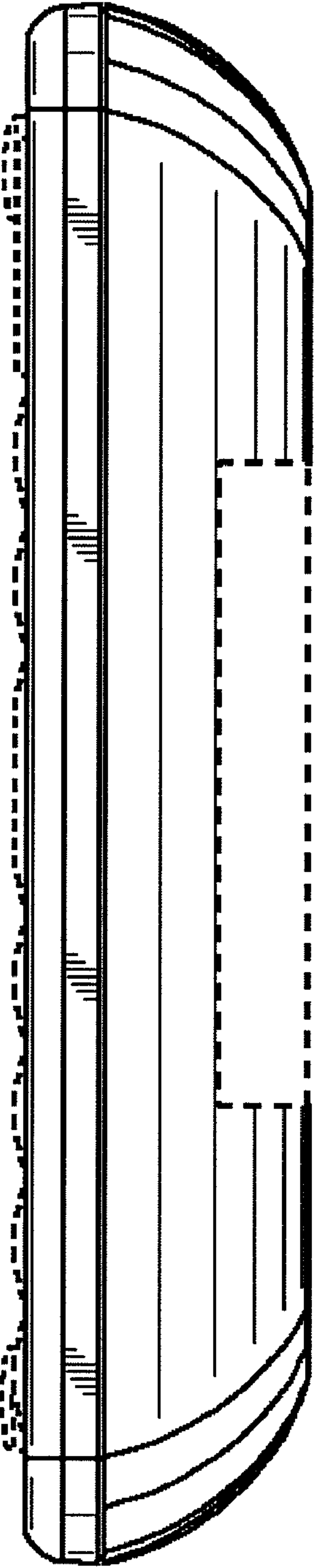

FIG. 6

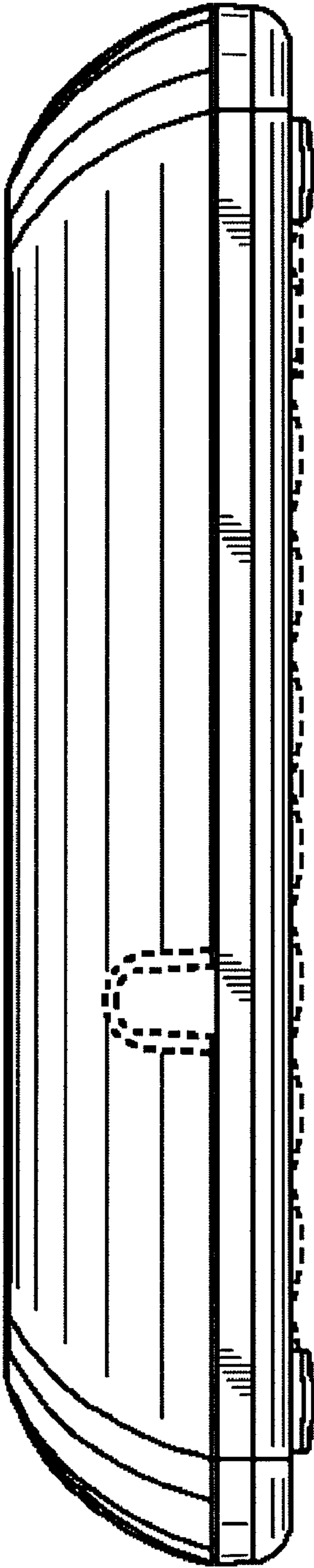

FIG. 7