

US00D660822S

(12) **United States Design Patent**
Holst

(10) **Patent No.:** **US D660,822 S**
(45) **Date of Patent:** **** May 29, 2012**

(54) **NECKLOOP**

(75) Inventor: **Kristian Kiehn Holst**, Smorum (DK)

(73) Assignee: **Oticon A/S**, Smorum (DK)

(**) Term: **14 Years**

(21) Appl. No.: **29/362,249**

(22) Filed: **May 21, 2010**

(30) **Foreign Application Priority Data**

Nov. 25, 2009 (EM) 001640095-0001

(51) **LOC (9) Cl.** **14-01**

(52) **U.S. Cl.** **D14/205**

(58) **Field of Classification Search** D14/205,
D14/206, 223, 228, 238.1; 181/129, 130,
181/135; 379/430, 431, 433.02; 381/380,
381/381; 455/90.3, 575.1; D10/104.1; D13/133,
D13/154

See application file for complete search history.

(56) **References Cited**

U.S. PATENT DOCUMENTS

1,218,138	A *	3/1917	Watcher	24/114.5
3,667,569	A *	6/1972	Mackey et al.	181/135
3,671,685	A *	6/1972	McCabe	381/382
D270,634	S *	9/1983	Ungar	D14/205
D332,098	S *	12/1992	Riley et al.	D14/225
5,726,388	A *	3/1998	Ferland	174/72 C
5,793,352	A *	8/1998	Greenberg et al.	345/699
6,280,243	B1 *	8/2001	Liu et al.	439/502
D471,890	S *	3/2003	Clarkson	D14/205
D481,377	S *	10/2003	Eguchi	D14/223
6,871,732	B2 *	3/2005	Flint et al.	191/12 R
D509,797	S *	9/2005	Milan	D13/133
D561,112	S *	2/2008	Victor	D13/154
D566,044	S *	4/2008	D'Arco et al.	D13/133
D574,368	S *	8/2008	Chapman	D14/225

D574,785	S *	8/2008	Victor	D13/154
D576,948	S *	9/2008	Bernstine	D13/133
D578,507	S *	10/2008	Ando	D14/205
D578,508	S *	10/2008	Wang	D14/206
D582,889	S *	12/2008	Bose et al.	D14/205
D584,295	S *	1/2009	Kellar	D14/228
D591,264	S *	4/2009	Hong et al.	D14/205
D595,690	S *	7/2009	Fullerton	D14/205
D599,778	S *	9/2009	Ando	D14/205
D599,779	S *	9/2009	Ando	D14/205
D605,628	S *	12/2009	Ando	D14/205
7,639,824	B2 *	12/2009	Franzen	381/151
D607,875	S *	1/2010	Pedersen, II	D14/206
7,778,435	B2 *	8/2010	Smith et al.	381/380
D634,299	S *	3/2011	Nara et al.	D14/206
D643,414	S *	8/2011	Lee et al.	D14/223

* cited by examiner

Primary Examiner — Paula Greene

(74) *Attorney, Agent, or Firm* — Birch, Stewart, Kolasch & Birch, LLP

(57) **CLAIM**

The ornamental design for a neckloop, as shown and described.

DESCRIPTION

FIG. 1 is a perspective view of the neckloop showing my new design;

FIG. 2 is a first side view thereof, the second side (opposite the first side) view being a mirror image thereof;

FIG. 3 is a third side (perpendicular to the first side) view thereof;

FIG. 4 is a fourth side (opposite to the third side) view thereof;

FIG. 5 is an enlarged view of a portion of the first side view;

FIG. 6 is a third side view of the enlarged portion shown in FIG. 5; and,

FIG. 7 is a fourth side view of the enlarged portion shown in FIG. 5.

1 Claim, 6 Drawing Sheets

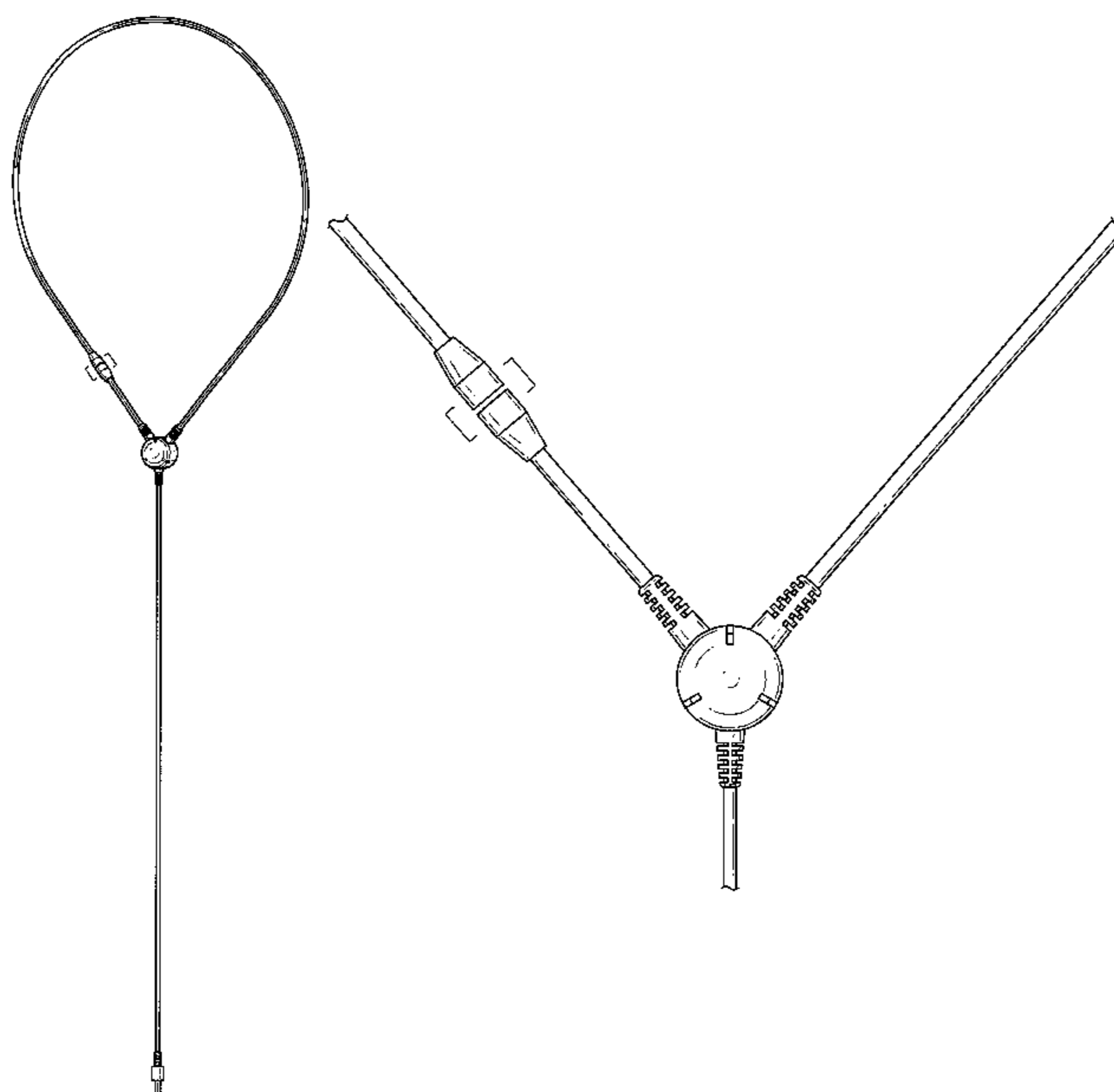

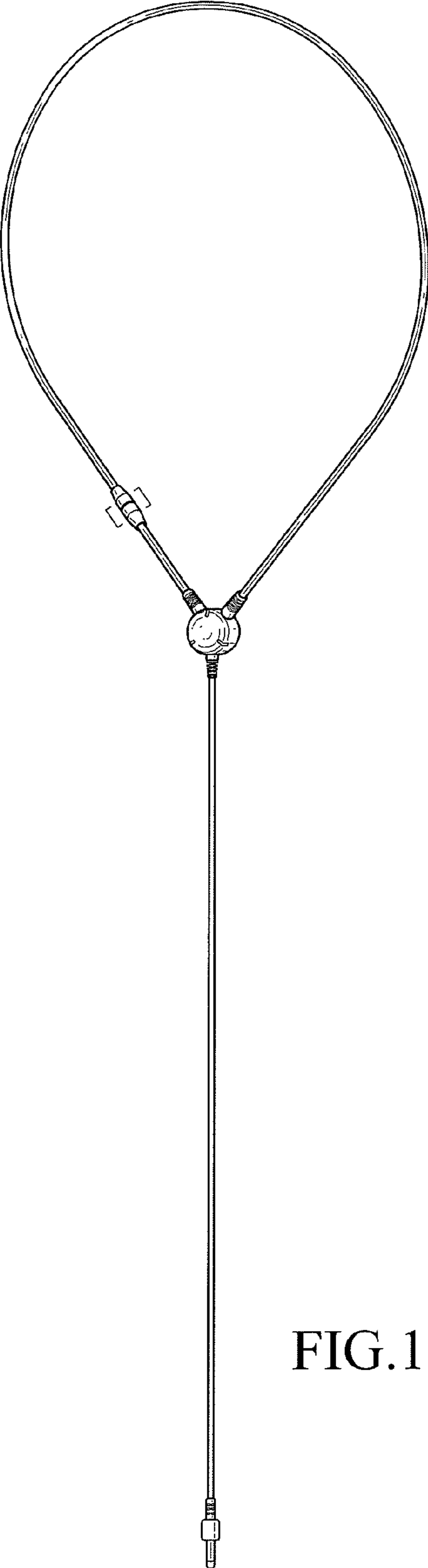

FIG. 1

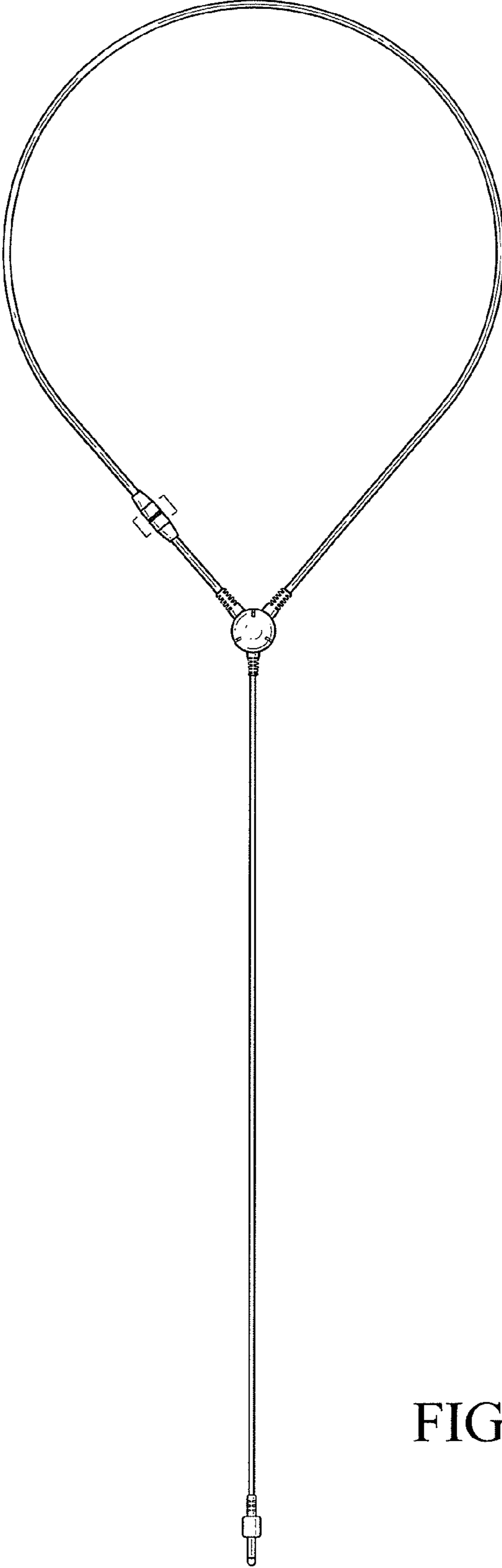

FIG.2

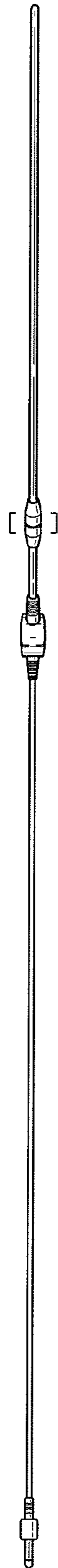

FIG.3

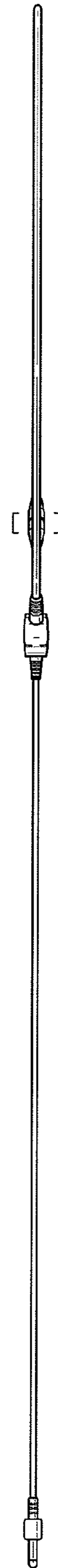

FIG.4

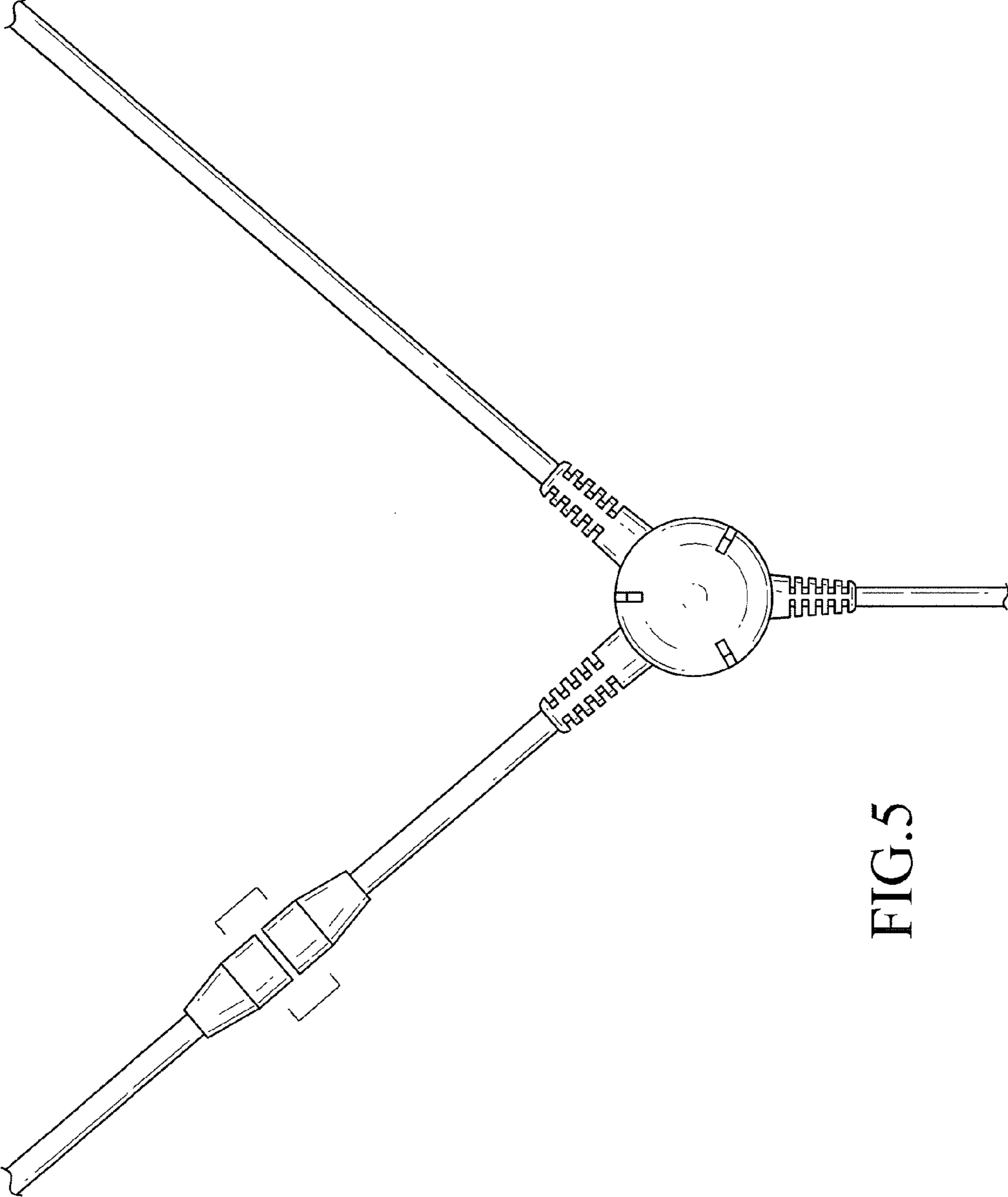

FIG.5

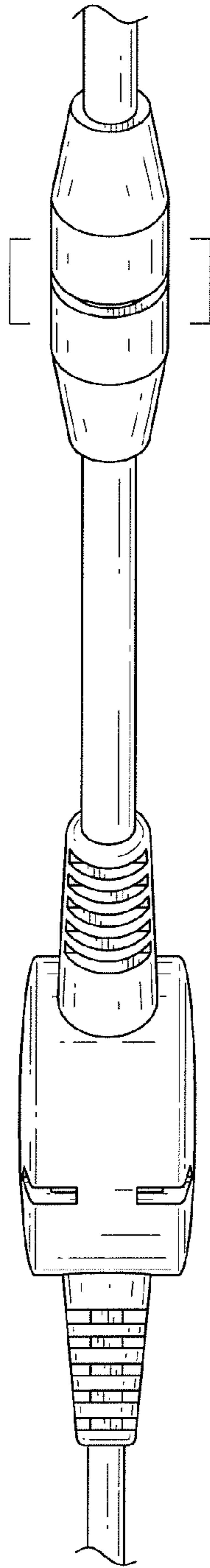

FIG.6

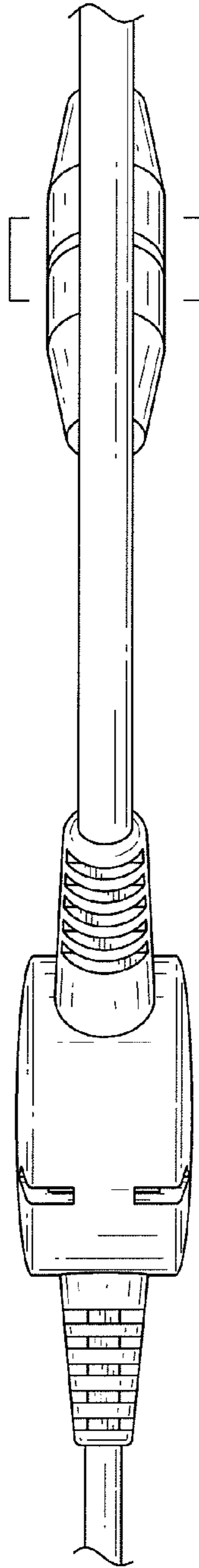

FIG. 7

UNITED STATES PATENT AND TRADEMARK OFFICE
CERTIFICATE OF CORRECTION

PATENT NO. : D660,822 S
APPLICATION NO. : 29/362249
DATED : May 29, 2012
INVENTOR(S) : Kristian Kiehn Holst

Page 1 of 1

It is certified that error appears in the above-identified patent and that said Letters Patent is hereby corrected as shown below:

ON THE TITLE PAGE:

At item (73), Assignee, change “**Oticon A/S, Smorun (DK)**” to “**--Oticon A/S, Smorum (DK)--**”.

Signed and Sealed this
Thirtieth Day of October, 2012

A handwritten signature in black ink that reads "David J. Kappos". The signature is written in a cursive style with a large initial 'D' and 'K'.

David J. Kappos
Director of the United States Patent and Trademark Office