



US00D660739S

(12) **United States Design Patent**
Coin

(10) **Patent No.:** **US D660,739 S**

(45) **Date of Patent:** **** May 29, 2012**

(54) **TURKEY GOBBLE CALL**

(76) Inventor: **Mark Coin**, Greenville, KY (US)

(**) Term: **14 Years**

(21) Appl. No.: **29/408,027**

(22) Filed: **Dec. 6, 2011**

(51) **LOC (9) Cl.** **10-05**

(52) **U.S. Cl.** **D10/119.1**

(58) **Field of Classification Search** D10/119.1,
D10/119.3; 446/202-209

See application file for complete search history.

(56) **References Cited**

U.S. PATENT DOCUMENTS

2,396,359	A	3/1946	Yager	
2,488,838	A	11/1949	Tierce	
2,544,370	A	3/1951	Walther	
2,556,388	A	6/1951	Bicocchi	
2,651,141	A	9/1953	Bicocchi	
2,711,614	A	6/1955	Halsten	
2,835,077	A	5/1958	Mittelsteadt	
3,955,313	A *	5/1976	Faulk	446/208
4,138,800	A	2/1979	Lege	
4,737,130	A	4/1988	Mann	
4,950,198	A	8/1990	Repko, Jr.	
4,950,201	A *	8/1990	Sceery	446/207
5,234,368	A	8/1993	Carraway	
5,549,498	A *	8/1996	Kirby	446/193
6,435,933	B1 *	8/2002	Browne	446/207

D502,119	S *	2/2005	Primos et al.	D10/119.1
2005/0076768	A1	4/2005	Pfortmiller et al.		
2009/0258566	A1 *	10/2009	May	446/208
2010/0240275	A1 *	9/2010	Rowley et al.	446/208

OTHER PUBLICATIONS

Midwest Turkey Call Supply—online catalog “TF-07 Turkey Flute”.

* cited by examiner

Primary Examiner — George D Kirschbaum

(74) *Attorney, Agent, or Firm* — Waddey & Patterson, PC; Matthew C. Cox

(57) **CLAIM**

What is claimed is the ornamental design for a turkey gobble call, as shown and described.

DESCRIPTION

FIG. 1 is a left side perspective view showing the turkey gobble call of Applicant’s invention.

FIG. 2 is a right side perspective view of the turkey gobble call of Applicant’s invention.

FIG. 3 is a right side elevation view of the turkey gobble call of Applicant’s invention, both sides being identical.

FIG. 4 is a left end view of the turkey gobble call of Applicant’s invention; and,

FIG. 5 is a right end view of the turkey gobble call of Applicant’s invention.

The broken line showing of interior elements seen in FIGS. 4 and 5 are included for the purpose of illustrating portions of the “article” and forms no part of the claimed design.

1 Claim, 2 Drawing Sheets

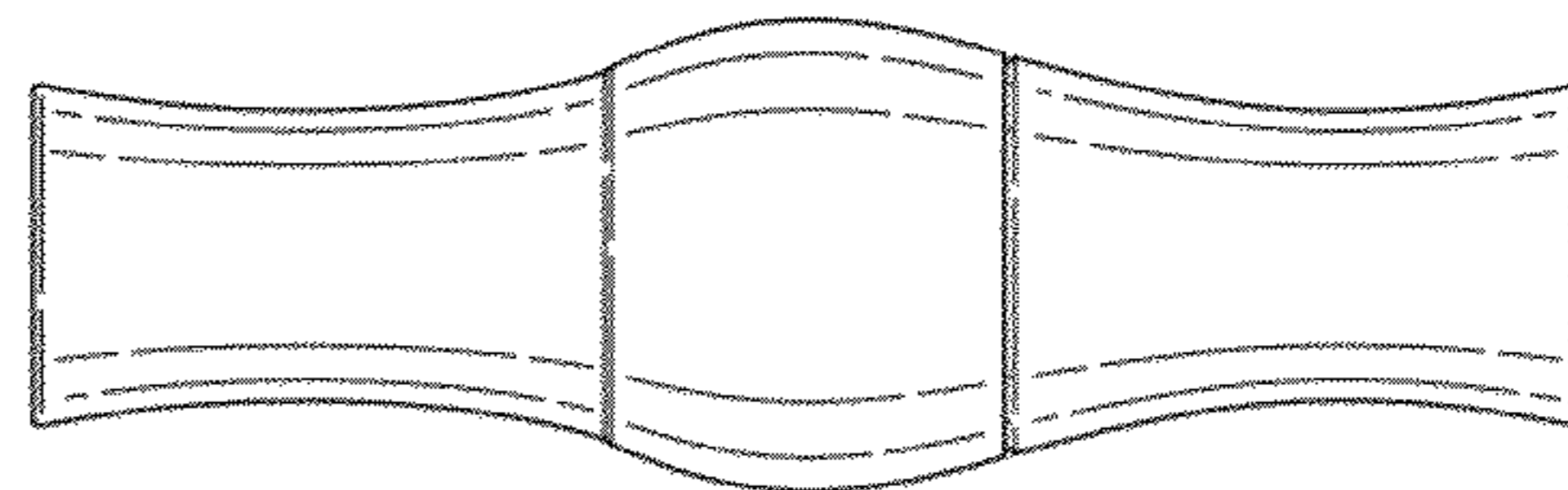
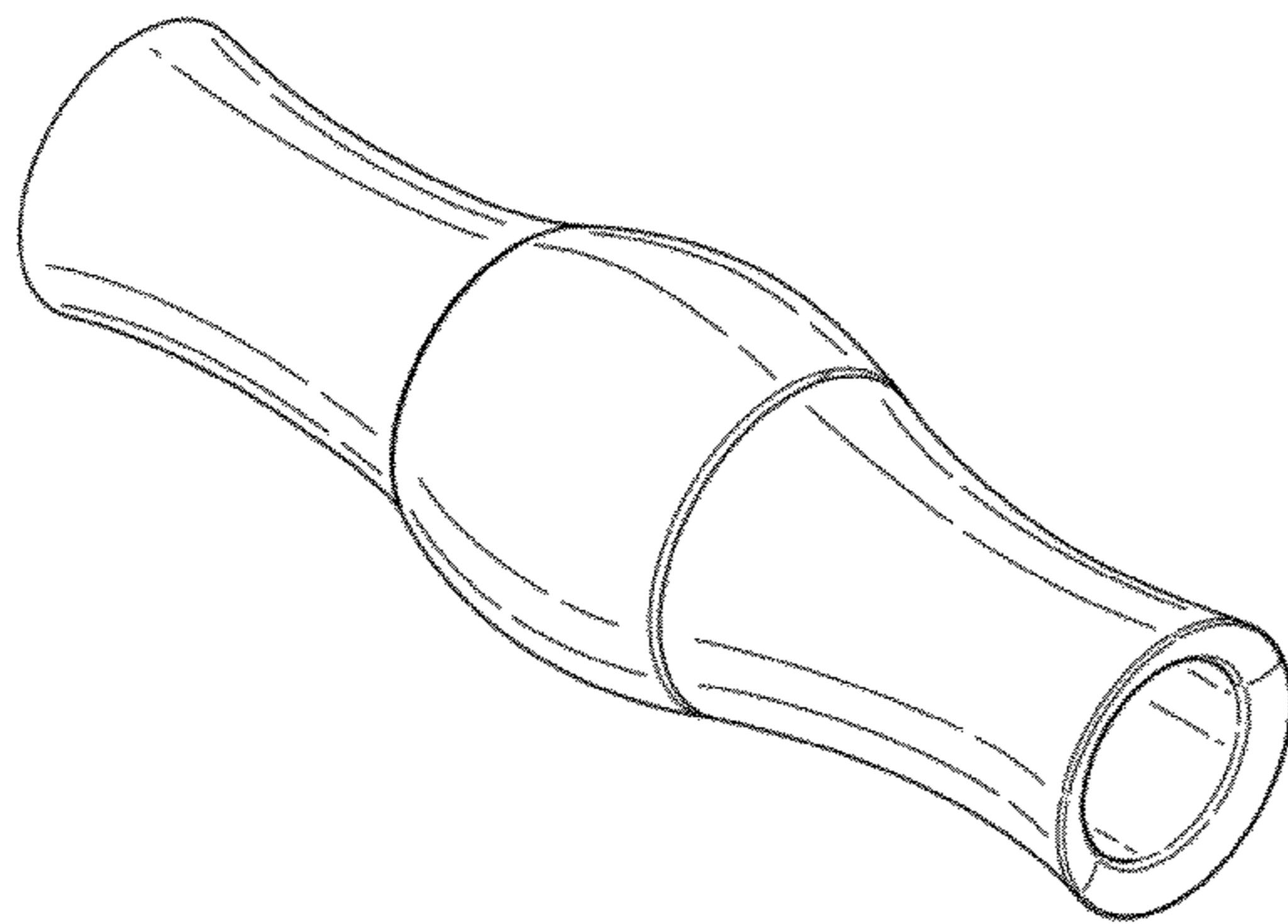

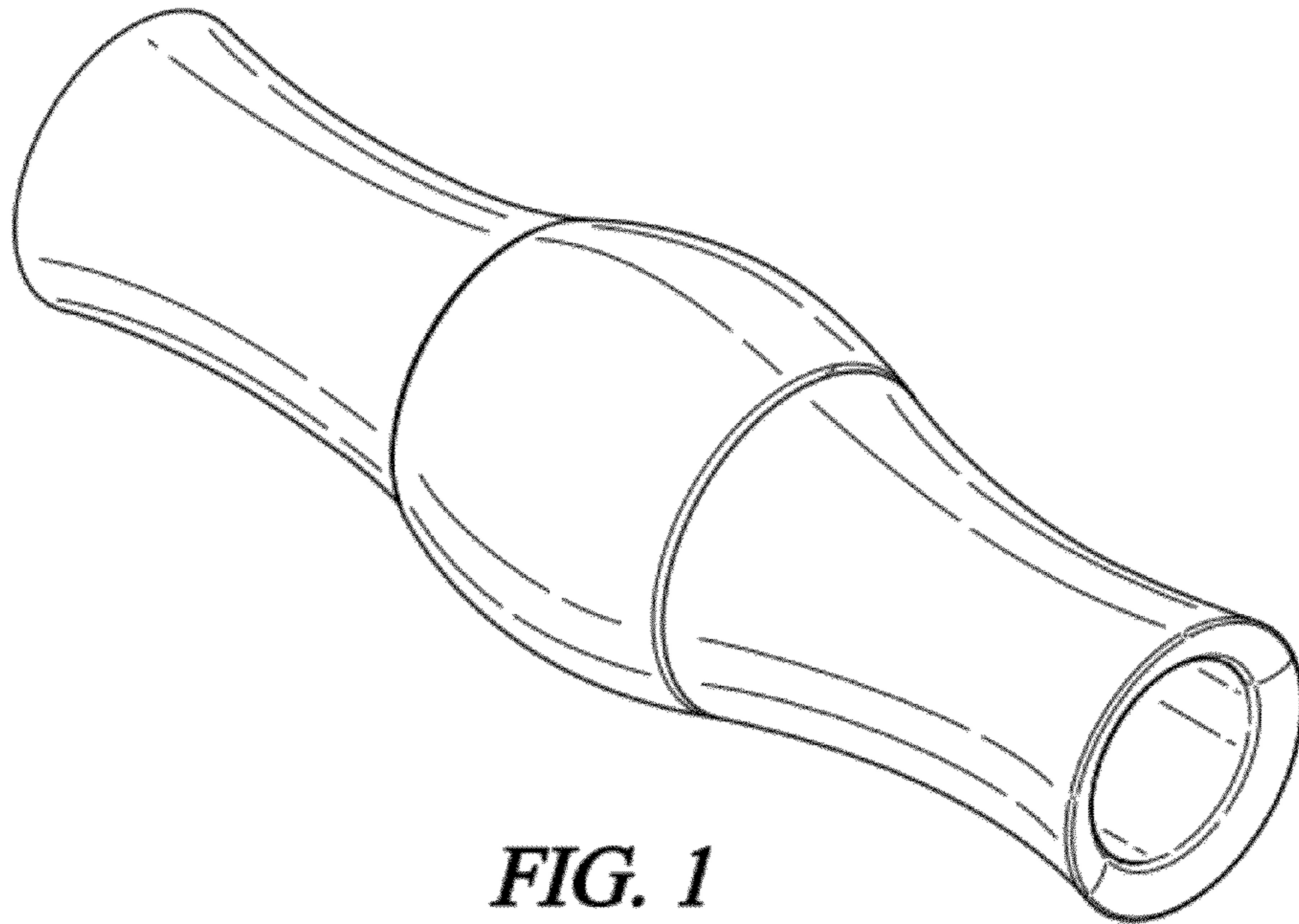

FIG. 1

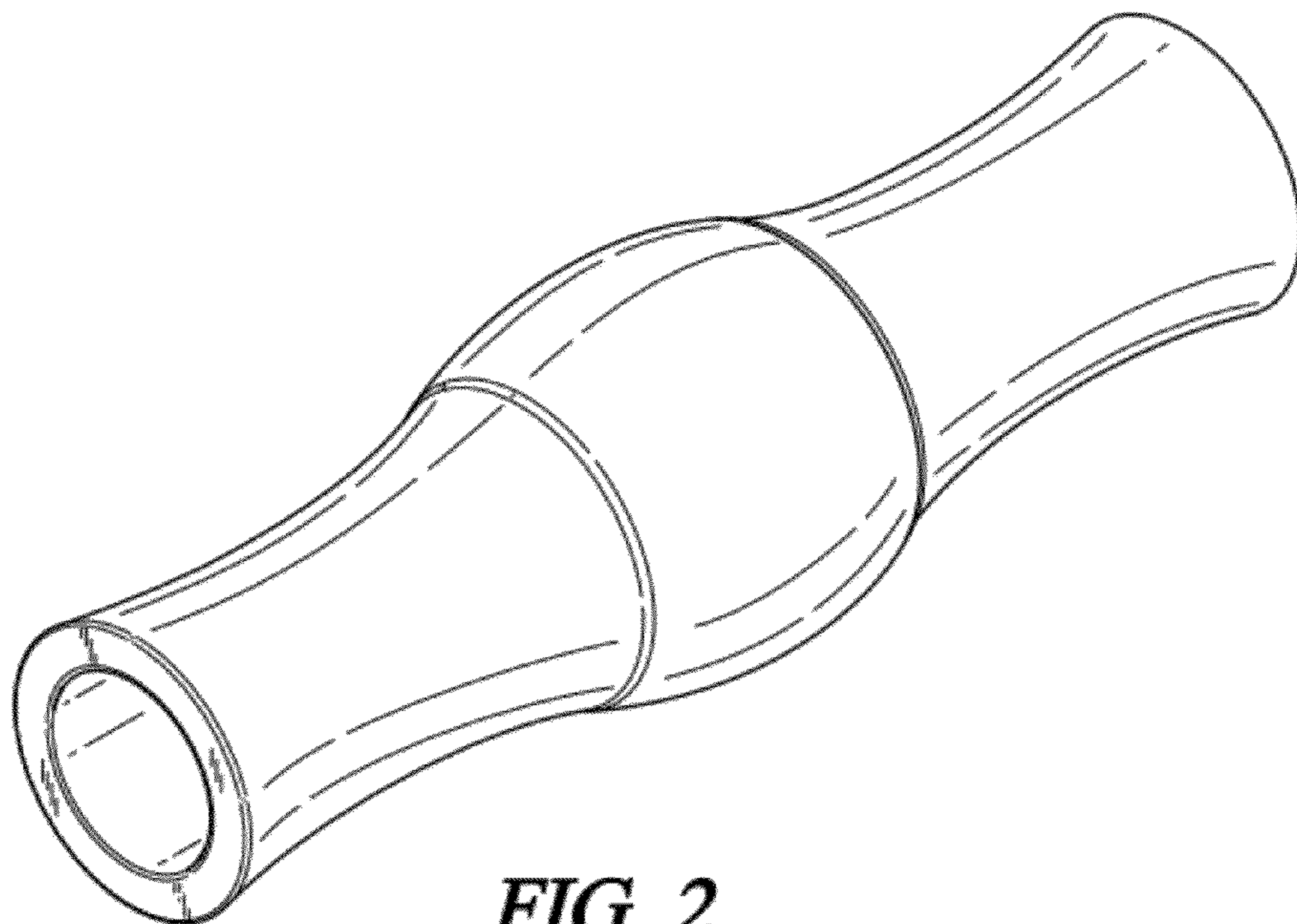

FIG. 2

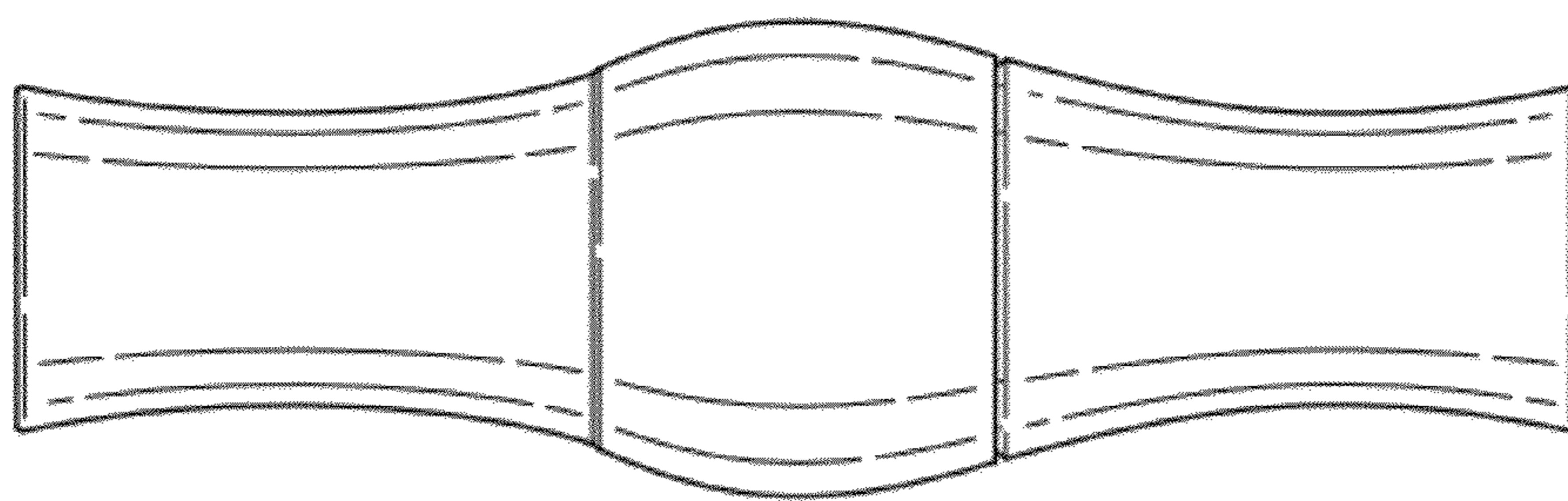

FIG. 3

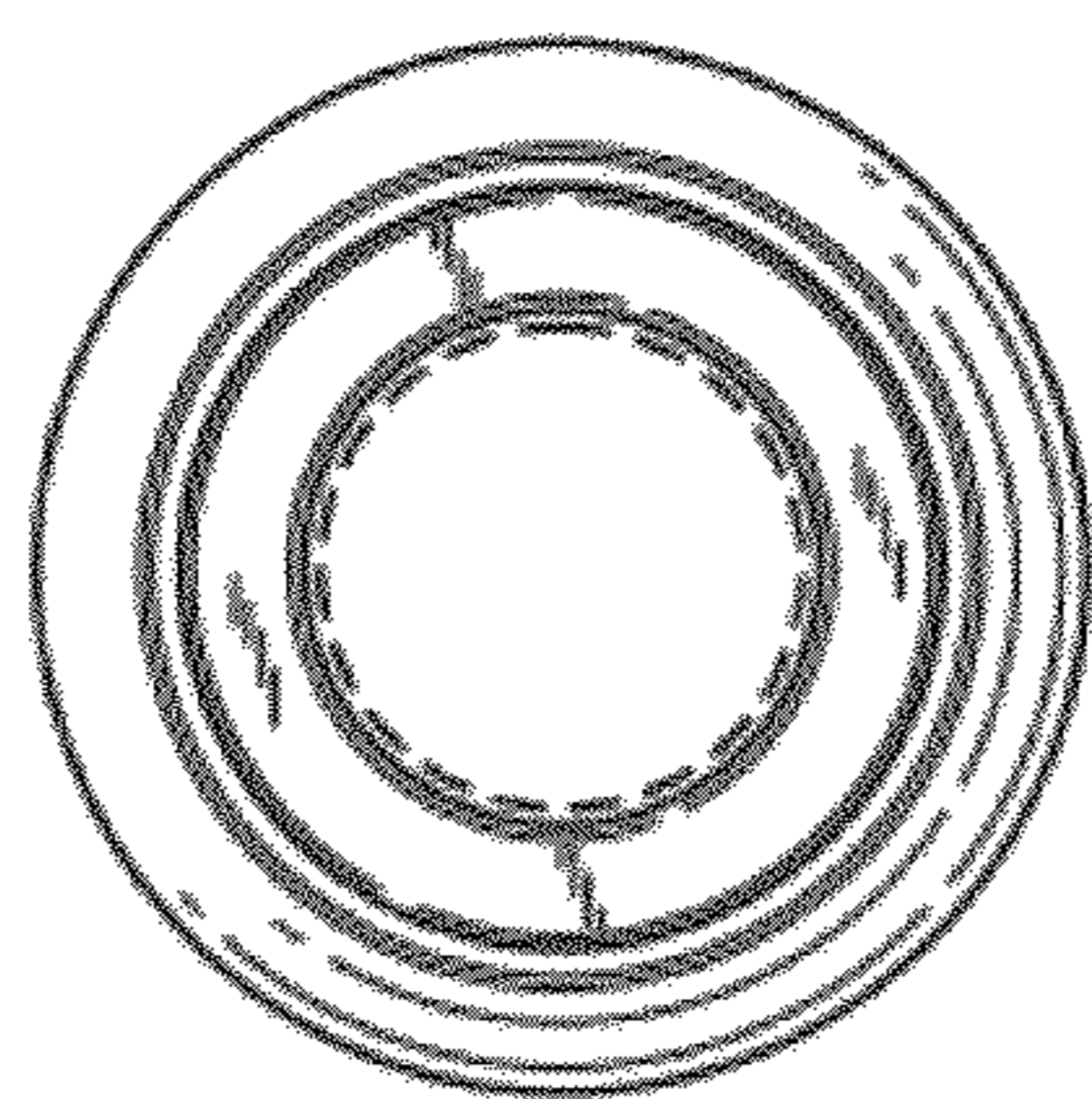

FIG. 4

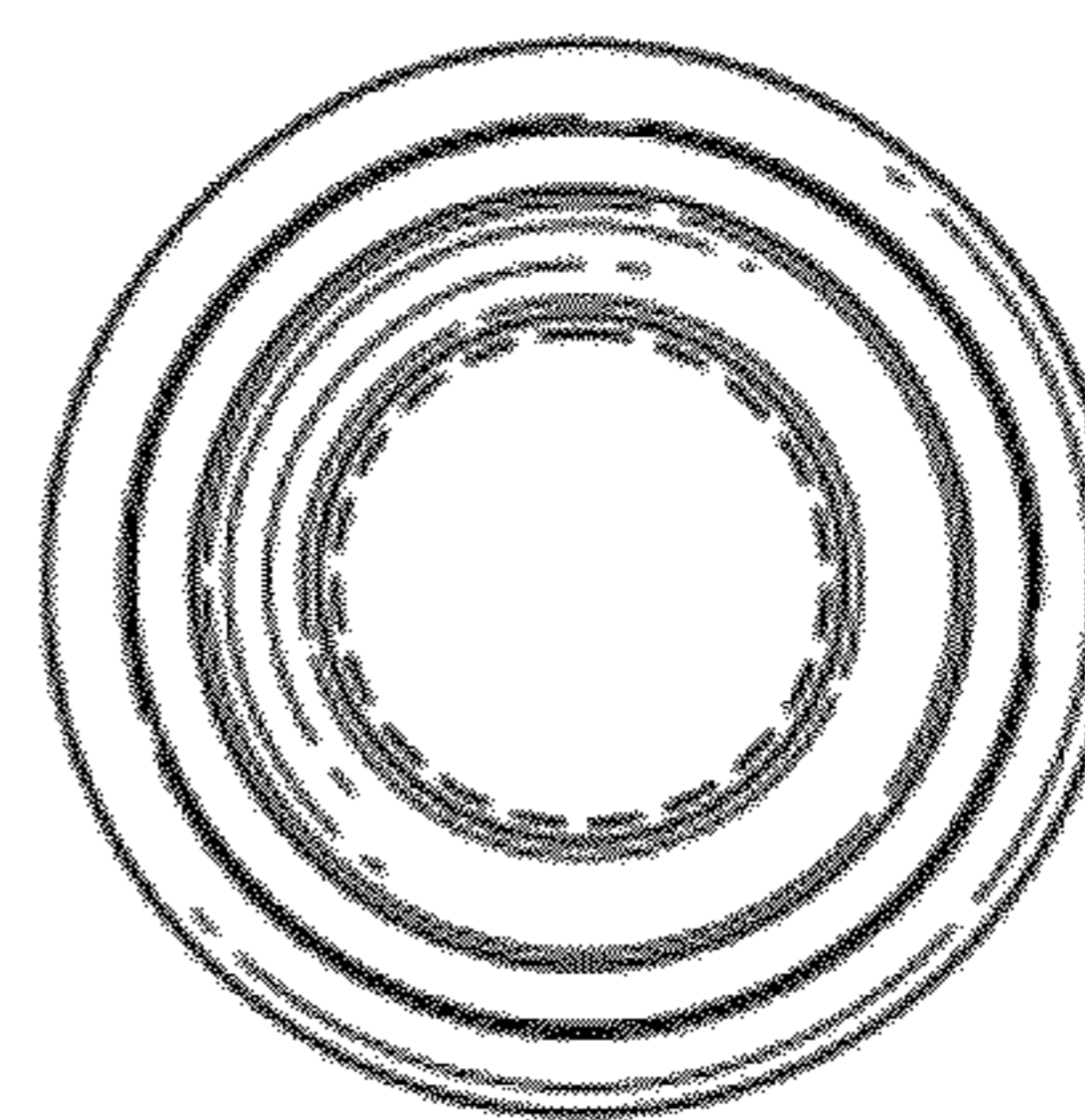

FIG. 5