

US00D660737S

(12) **United States Design Patent**
O’Keefe et al.

(10) **Patent No.:** **US D660,737 S**

(45) **Date of Patent:** **** May 29, 2012**

(54) **IDENTIFICATION PANEL**

(75) Inventors: **Eoin S O’Keefe**, Farnborough (GB);
Loftus R Hall, Farnborough (GB); **Ross**
J McSherry, Farnborough (GB)

(73) Assignee: **QinetiQ Limited**, London (GB)

(**) Term: **14 Years**

(21) Appl. No.: **29/347,724**

(22) Filed: **Apr. 22, 2010**

(30) **Foreign Application Priority Data**

Oct. 22, 2009 (GB) 4012988

Oct. 22, 2009 (GB) 4012989

(51) **LOC (9) Cl.** **10-05**

(52) **U.S. Cl.** **D10/113.4; D10/109.1**

(58) **Field of Classification Search** D10/109.1,
D10/113.2, 113.4; D20/10; 116/63 R, 63 P,
116/63 C, 63; 40/610

See application file for complete search history.

(56) **References Cited**

U.S. PATENT DOCUMENTS

2,330,096	A	9/1943	Waters	
2,483,734	A *	10/1949	Neal	116/63 R
D273,095	S *	3/1984	Schulze	D10/109.1
5,115,343	A	5/1992	Bennett	
D350,301	S *	9/1994	McInally et al.	D10/113.2
5,567,950	A	10/1996	Meeker et al.	
D617,839	S *	6/2010	Jedlicka	D20/10
D617,840	S *	6/2010	Jedlicka	D20/10
D617,841	S *	6/2010	Jedlicka	D20/10
7,950,173	B2 *	5/2011	Jedlicka	40/610
2002/0066864	A1	6/2002	Reshef	
2007/0022939	A1 *	2/2007	Stokes	116/63 P

FOREIGN PATENT DOCUMENTS

EP	0 218 771	4/1987
EP	0 696 868	2/1996
GB	1 502 402	3/1978
WO	2005/110011	11/2005

OTHER PUBLICATIONS

UK Search Report dated Jan. 28, 2010 for GB 0918720.4.

* cited by examiner

Primary Examiner — George D Kirschbaum

(74) *Attorney, Agent, or Firm* — Nixon & Vanderhye P.C.

(57) **CLAIM**

The ornamental design for an identification panel, as shown and described.

DESCRIPTION

FIG. 1 is a top, front, perspective view of just the body of an identification panel showing our new design;

FIG. 2 is a top view thereof;

FIG. 3 is a bottom view thereof;

FIG. 4 is a front view thereof;

FIG. 5 is a rear side view thereof;

FIG. 6 is a right side view thereof;

FIG. 7 is a left side view thereof;

FIG. 8 is the assembled design as seen from a top front perspective view thereof;

FIG. 9 is a top view thereof;

FIG. 10 is a bottom view thereof;

FIG. 11 is a front view thereof;

FIG. 12 is a rear view thereof;

FIG. 13 is right side view thereof; and,

FIG. 14 is a left side view.

In the drawings, the dashed broken line showing represents stitching, and the broken dotted lines used on the tabs at each corner of the design depict environmental subject matter and forms no part of the claim.

1 Claim, 10 Drawing Sheets

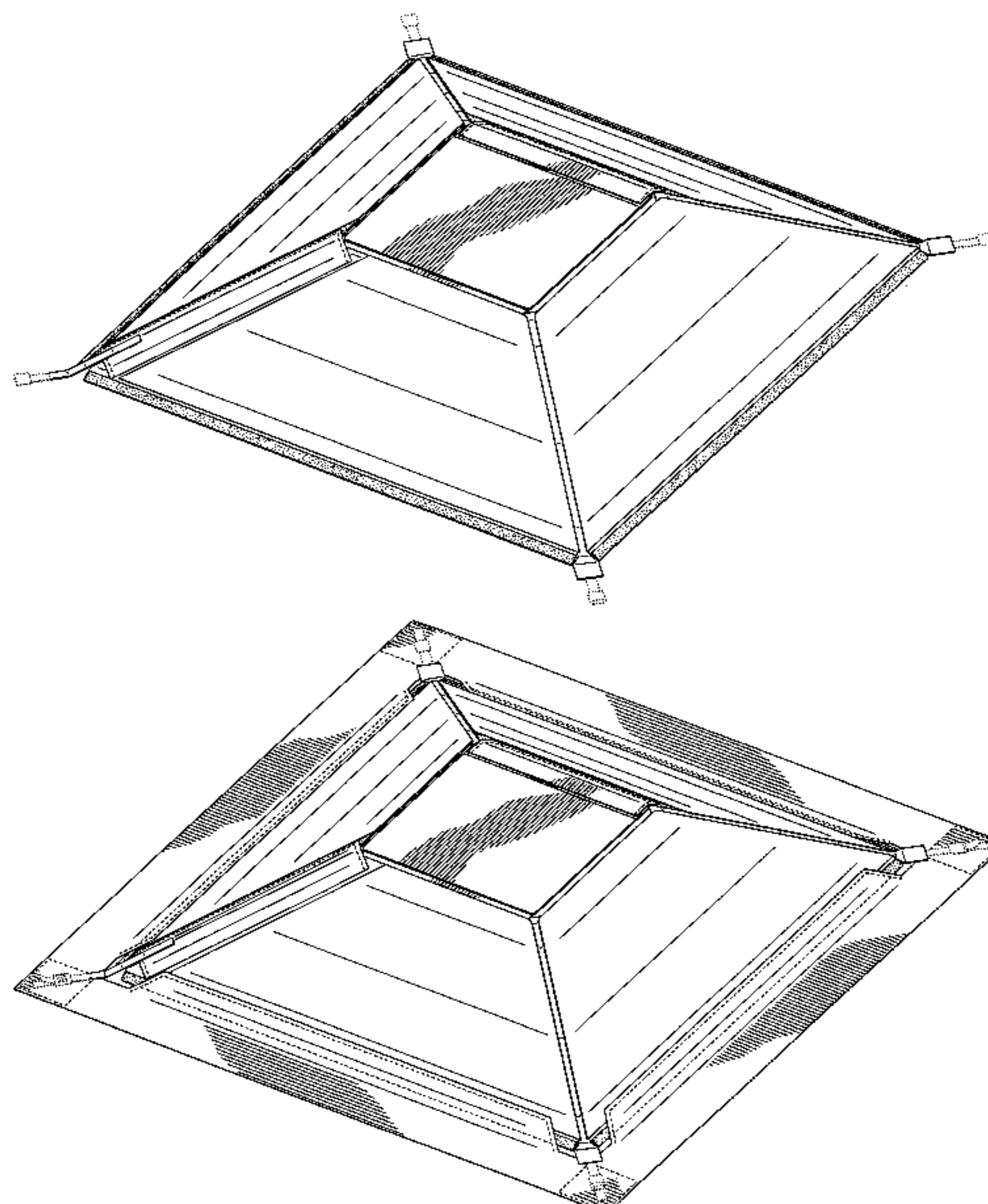

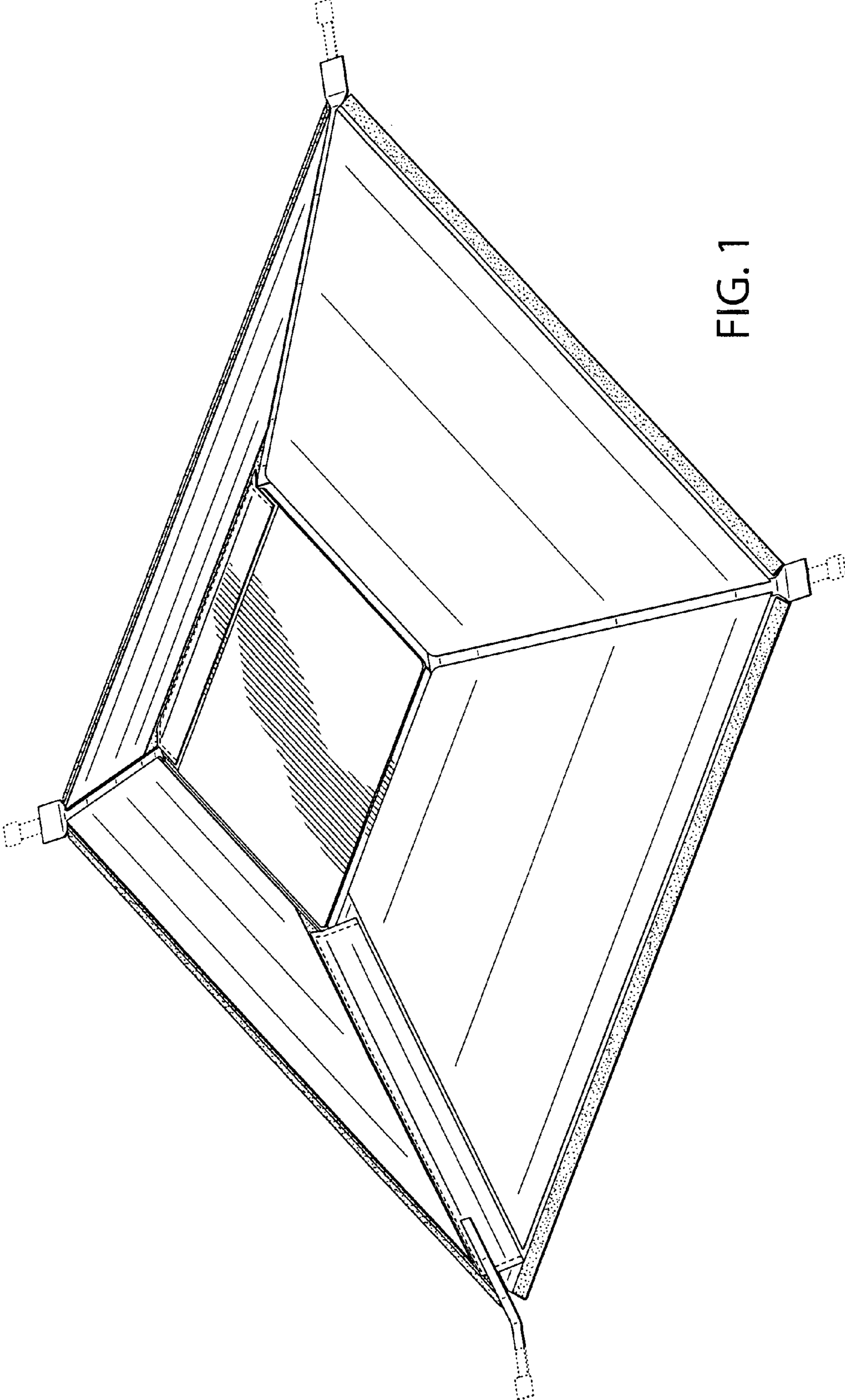

FIG. 1

FIG. 2

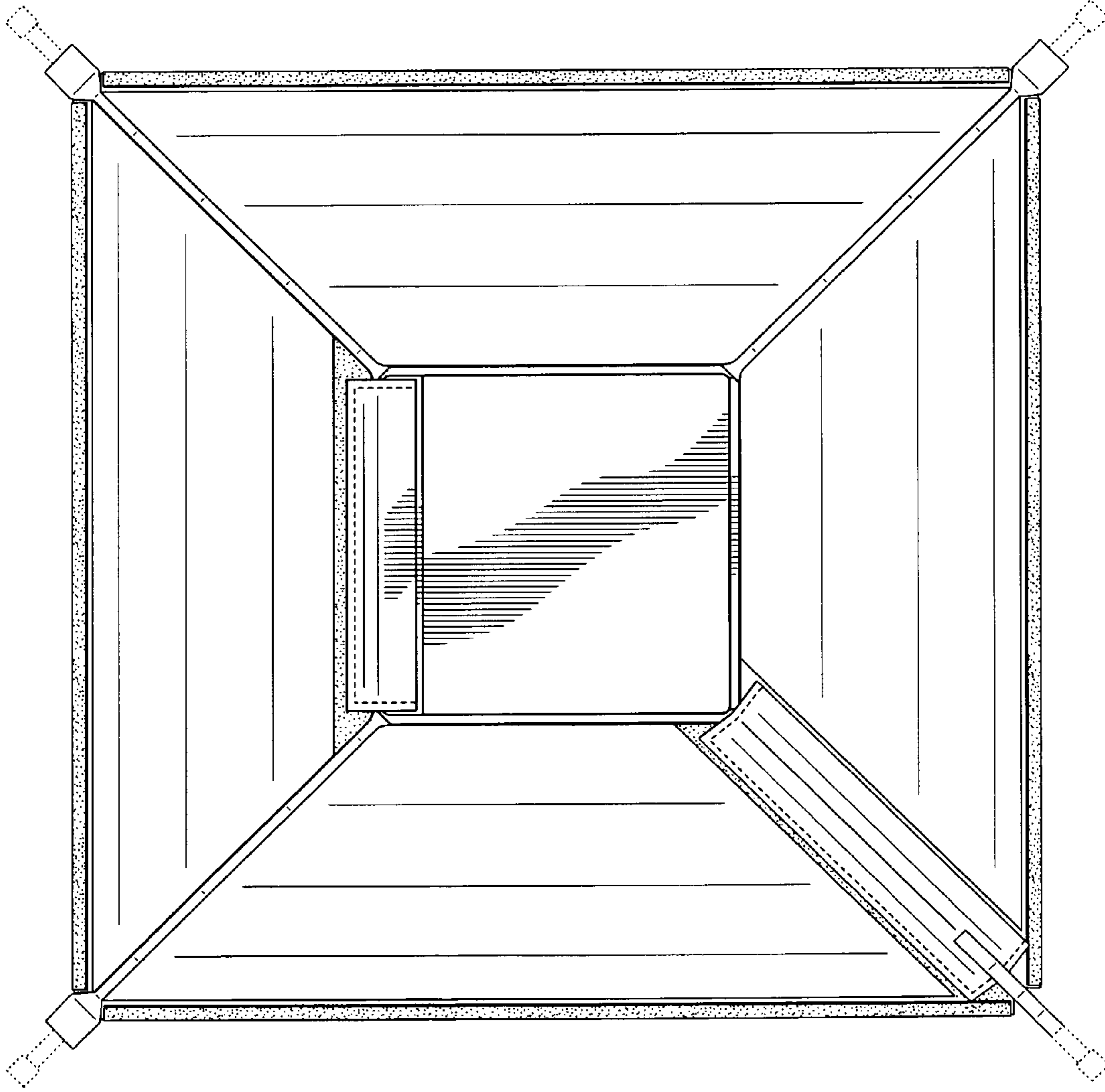
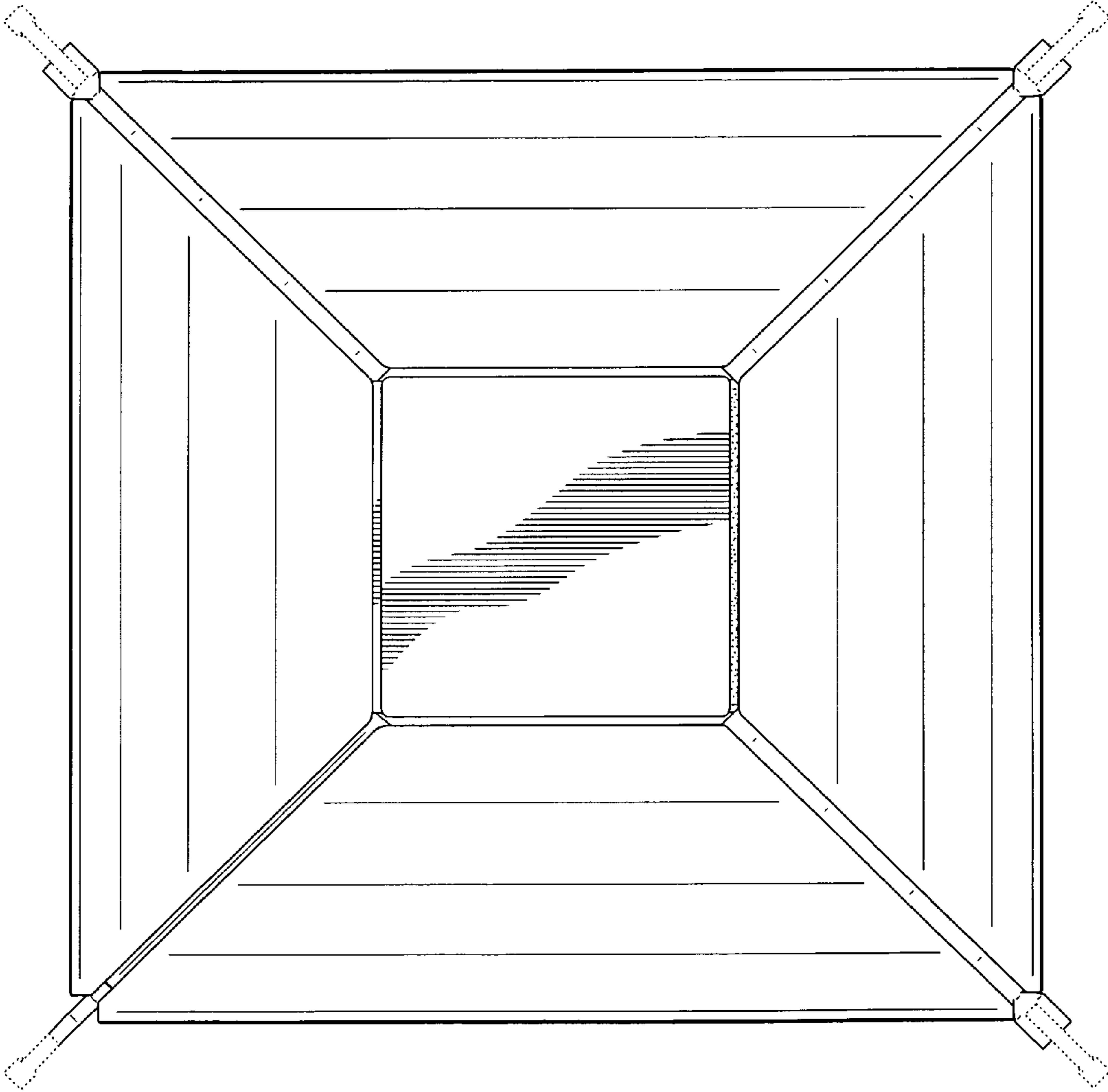

FIG. 3



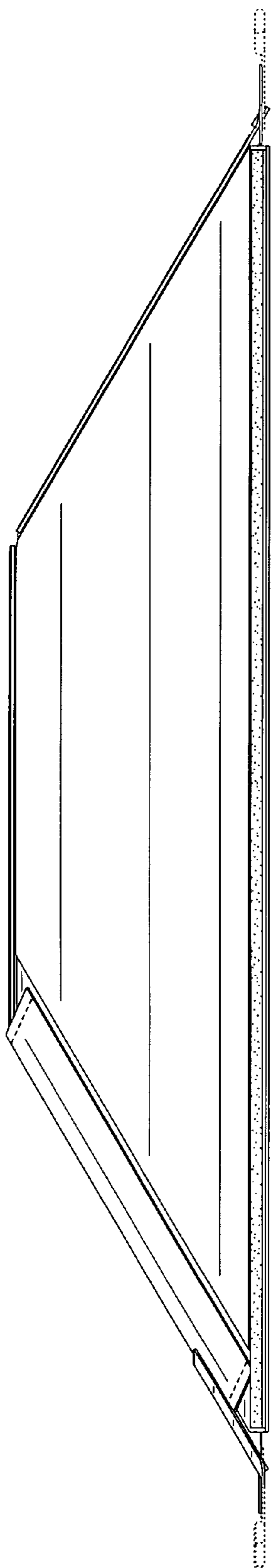

FIG. 4

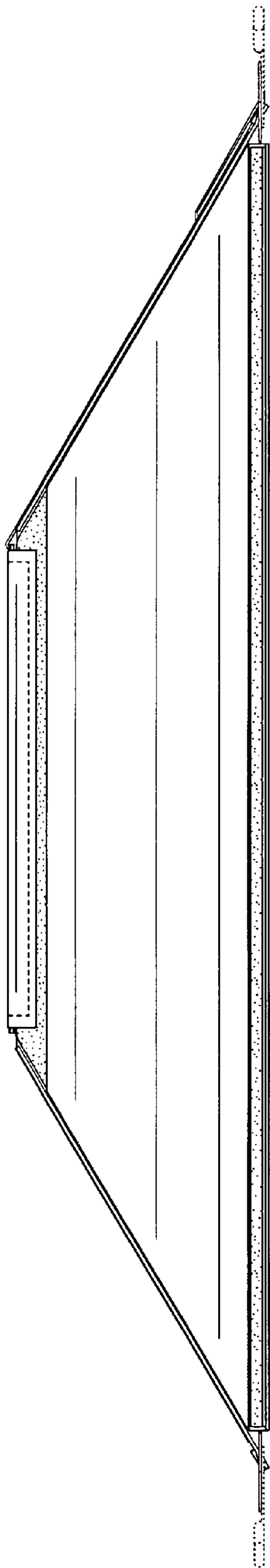

FIG. 5

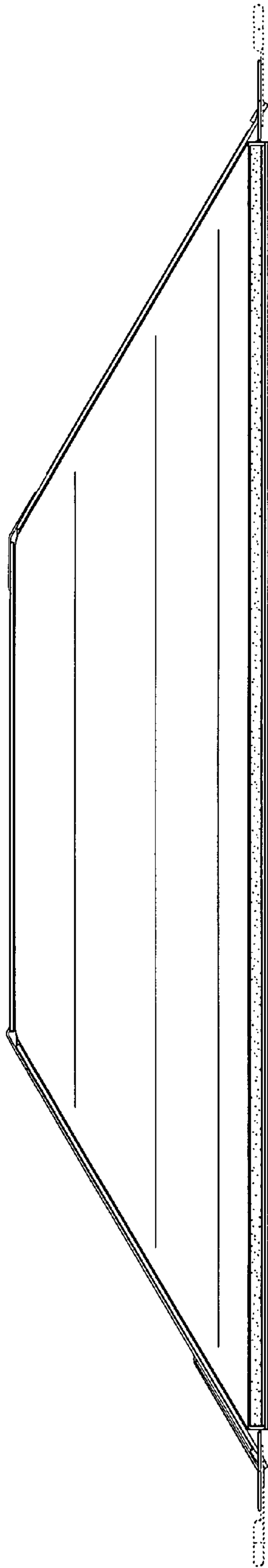

FIG. 6

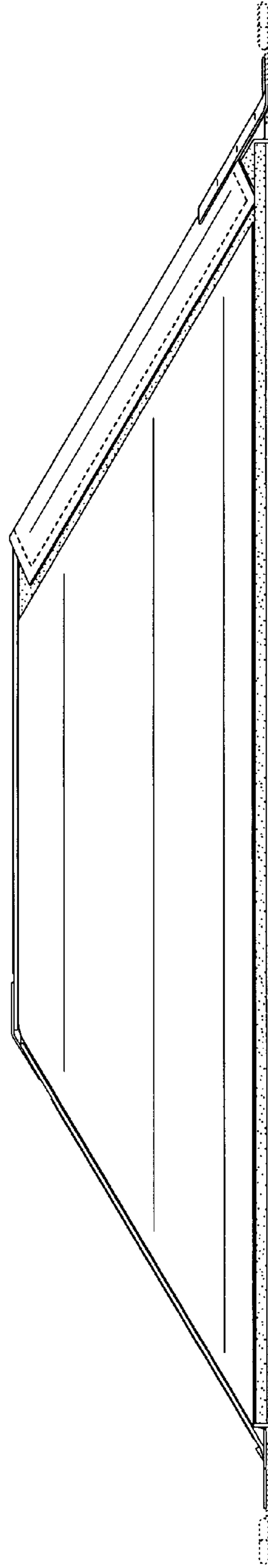

FIG. 7

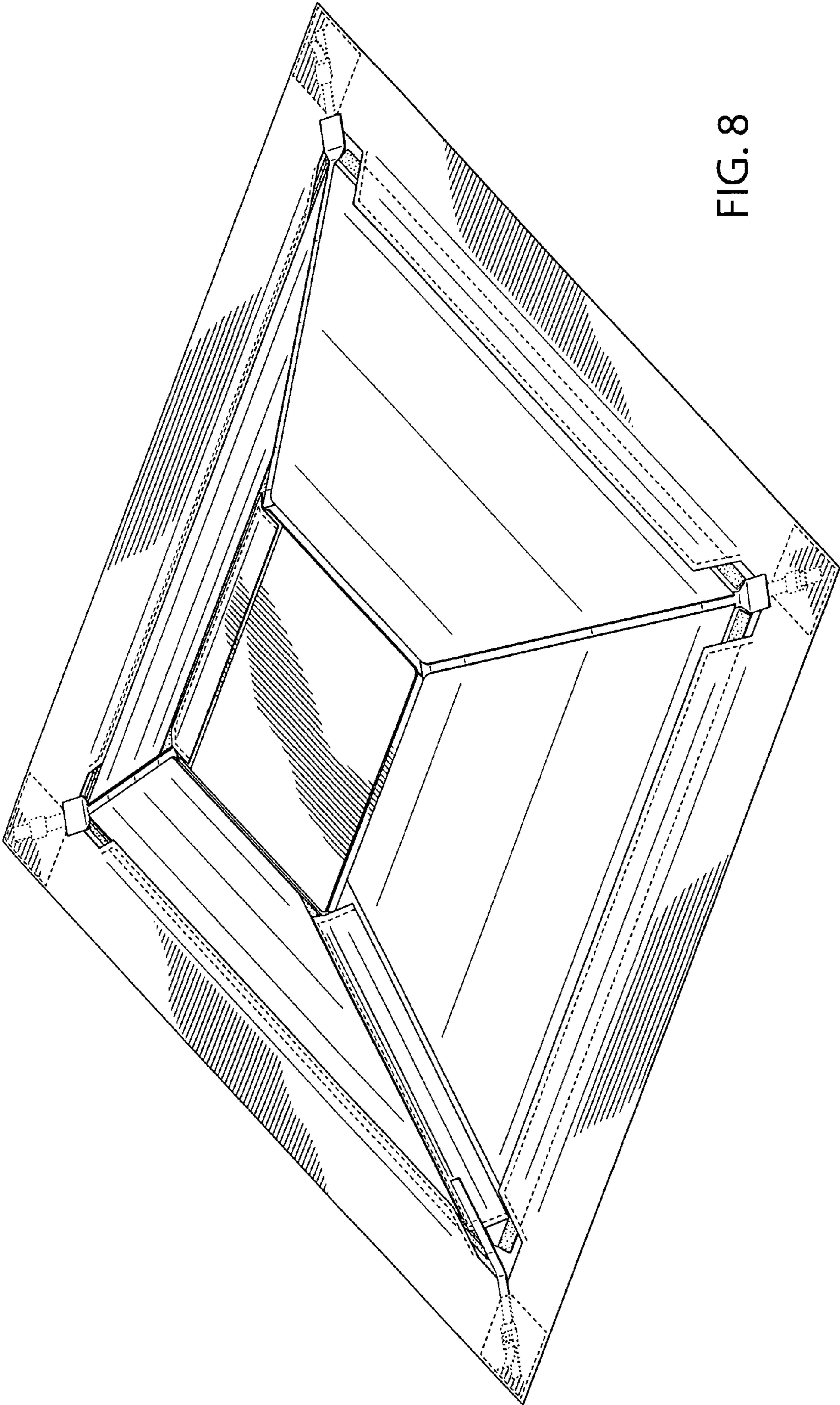

FIG. 8

FIG. 9

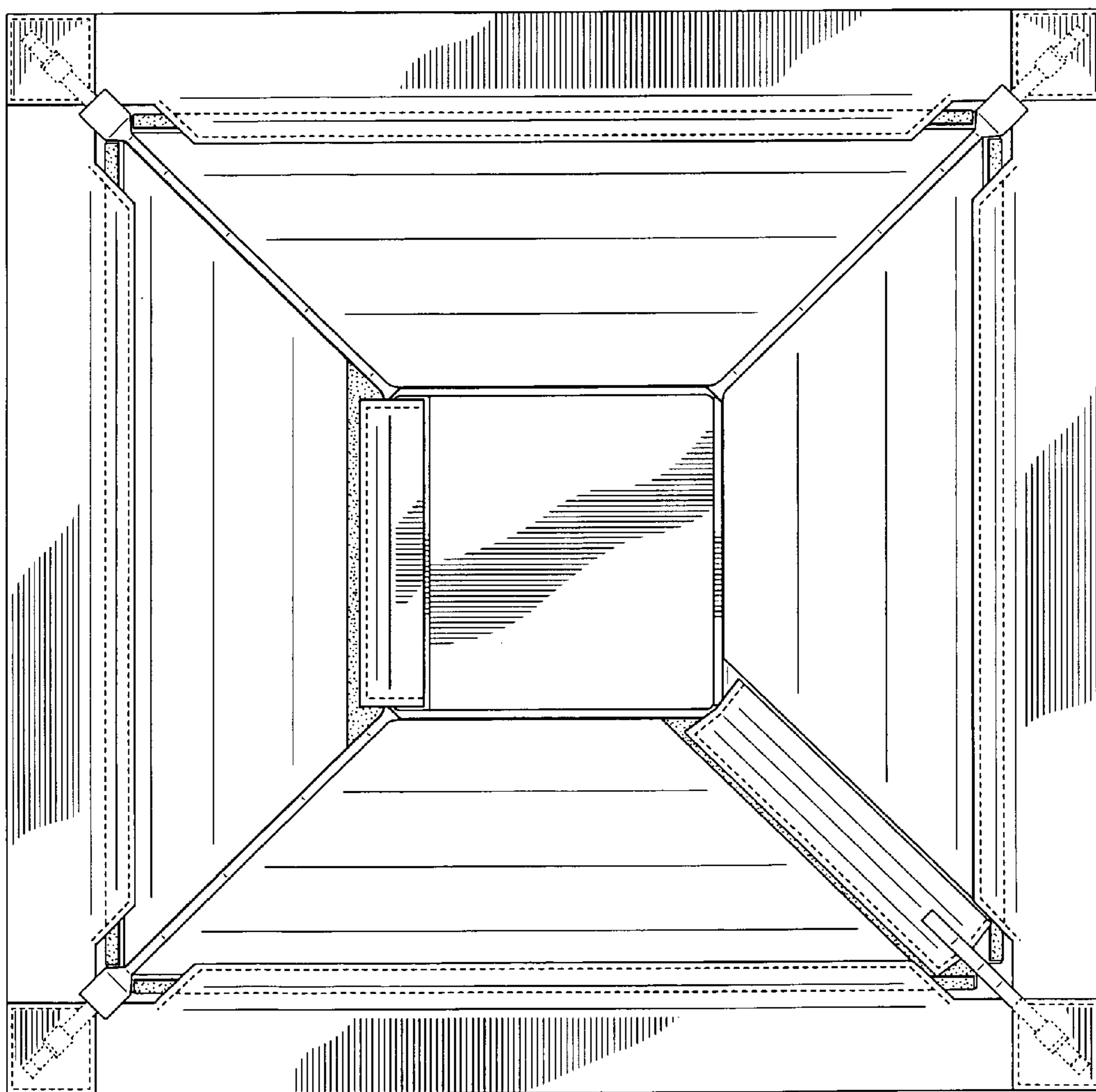
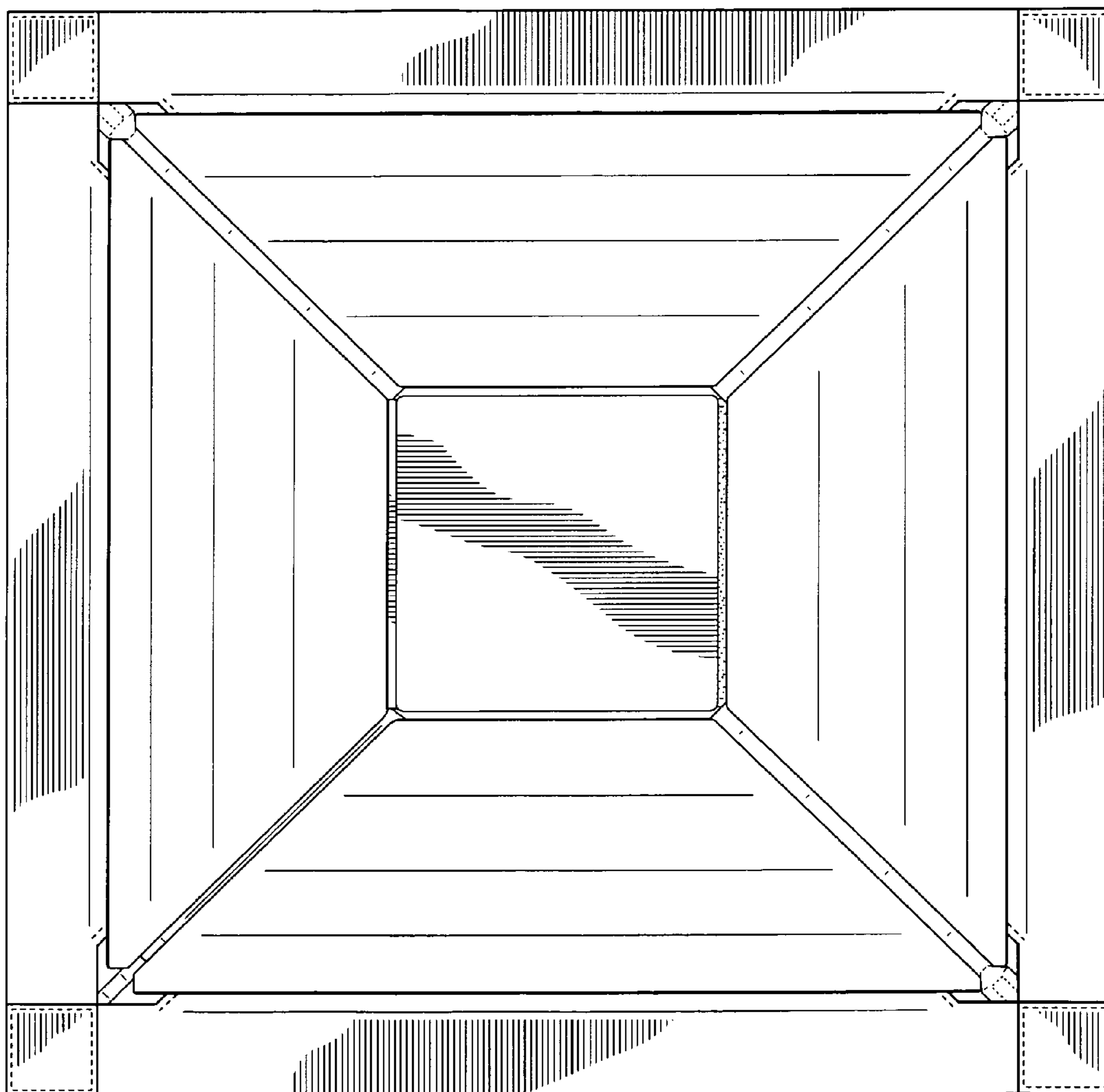

FIG. 10



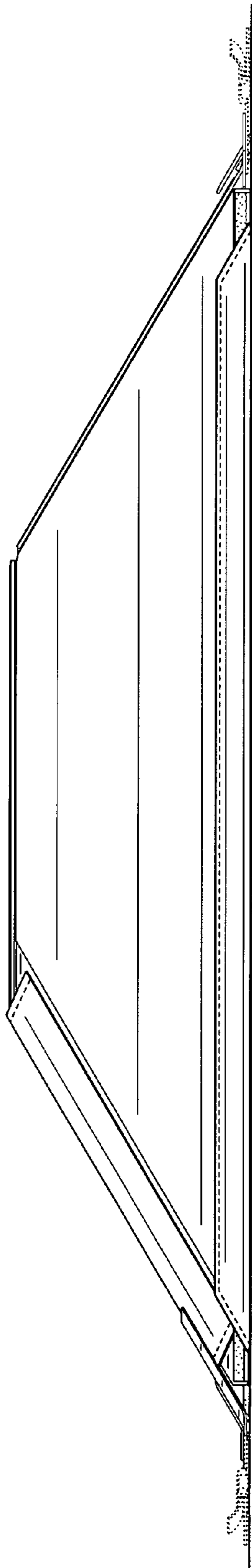

FIG. 11

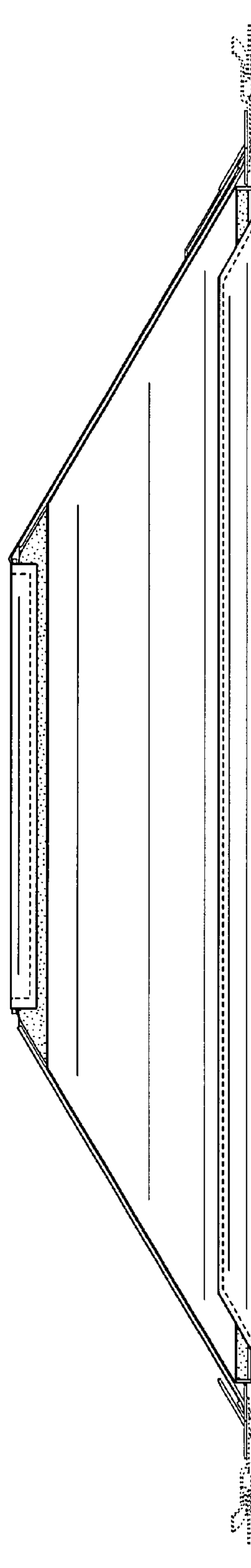

FIG. 12

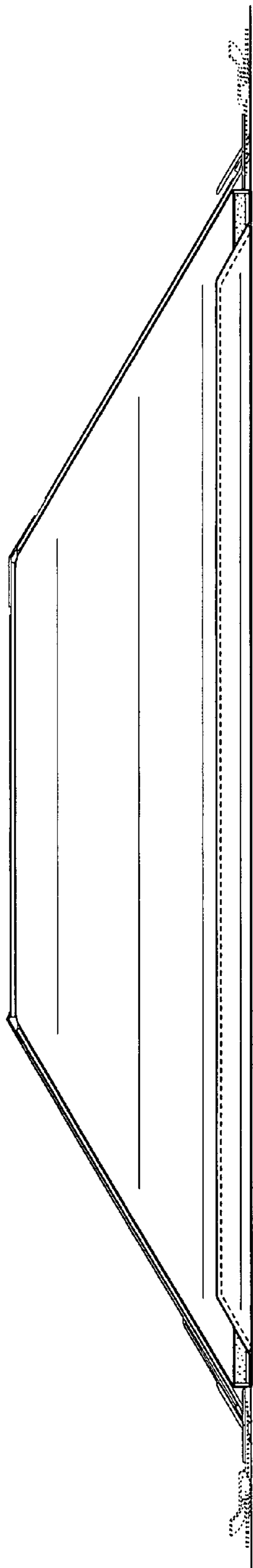

FIG. 13

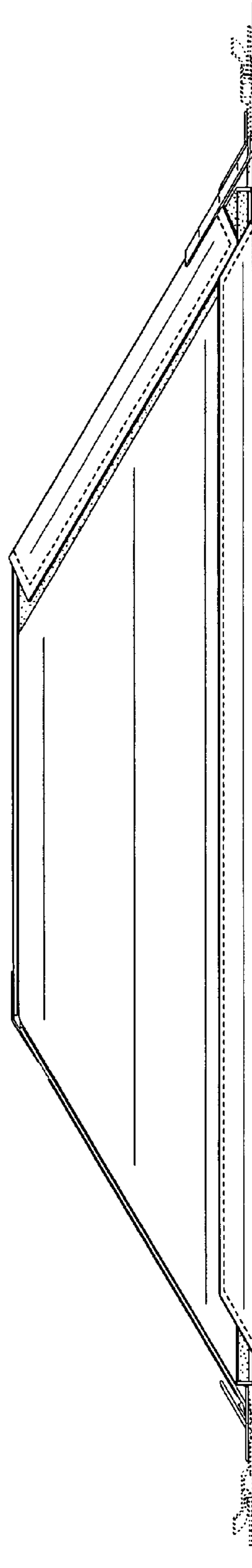

FIG. 14