

US00D660648S

(12) **United States Design Patent**  
**Gilbert**

(10) **Patent No.:** **US D660,648 S**

(45) **Date of Patent:** **\*\* May 29, 2012**

(54) **BEVERAGE CONTAINER**  
(75) Inventor: **Tyler Sean Gilbert**, Bellevue, WA (US)  
(73) Assignee: **Pacific Market International, LLC**,  
Seattle, WA (US)

(\*\*) Term: **14 Years**  
(21) Appl. No.: **29/381,390**

(22) Filed: **Dec. 17, 2010**  
(51) **LOC (9) Cl.** ..... **07-01**  
(52) **U.S. Cl.** ..... **D7/510; D7/511; D7/536**  
(58) **Field of Classification Search** ..... **D7/510,**  
**D7/511, 608, 536; 215/13.1; 206/217; 220/709,**  
**220/713**  
See application file for complete search history.

(56) **References Cited**

**U.S. PATENT DOCUMENTS**

5,553,745	A	*	9/1996	McMillian	.....	222/92
D421,547	S	*	3/2000	Demers	.....	D7/510
D586,183	S	*	2/2009	Junkel	.....	D7/511
D611,765	S	*	3/2010	George	.....	D7/510
D620,355	S	*	7/2010	Nardini	.....	D9/443
D621,220	S	*	8/2010	Lown et al.	.....	D7/510
D621,666	S	*	8/2010	Wahl	.....	D7/608

D623,460	S	*	9/2010	Krasner	.....	D7/300.1
D625,564	S	*	10/2010	He	.....	D7/608
D644,489	S	*	9/2011	Trombly	.....	D7/510
D648,177	S	*	11/2011	Eyal	.....	D7/510
D651,044	S	*	12/2011	Gilbert	.....	D7/510
2009/0236341	A1	*	9/2009	McKinney et al.	.....	220/375

\* cited by examiner

*Primary Examiner* — Marianne Pandozzi  
(74) *Attorney, Agent, or Firm* — Davis Wright Tremaine  
LLP; George C. Rondeau, Jr.

(57) **CLAIM**  
The ornamental design for a beverage container, as shown and described.

**DESCRIPTION**

FIG. 1 is a top left side perspective view of a beverage container showing my new design.  
FIG. 2 is a rear elevational view thereof.  
FIG. 3 is a front elevational view thereof.  
FIG. 4 is a right side elevational view thereof  
FIG. 5 is a left side elevational view thereof.  
FIG. 6 is a top plan view thereof; and,  
FIG. 7 is a bottom plan view thereof.  
The broken lines represent portions of the beverage container that form no part of the claim.

**1 Claim, 4 Drawing Sheets**

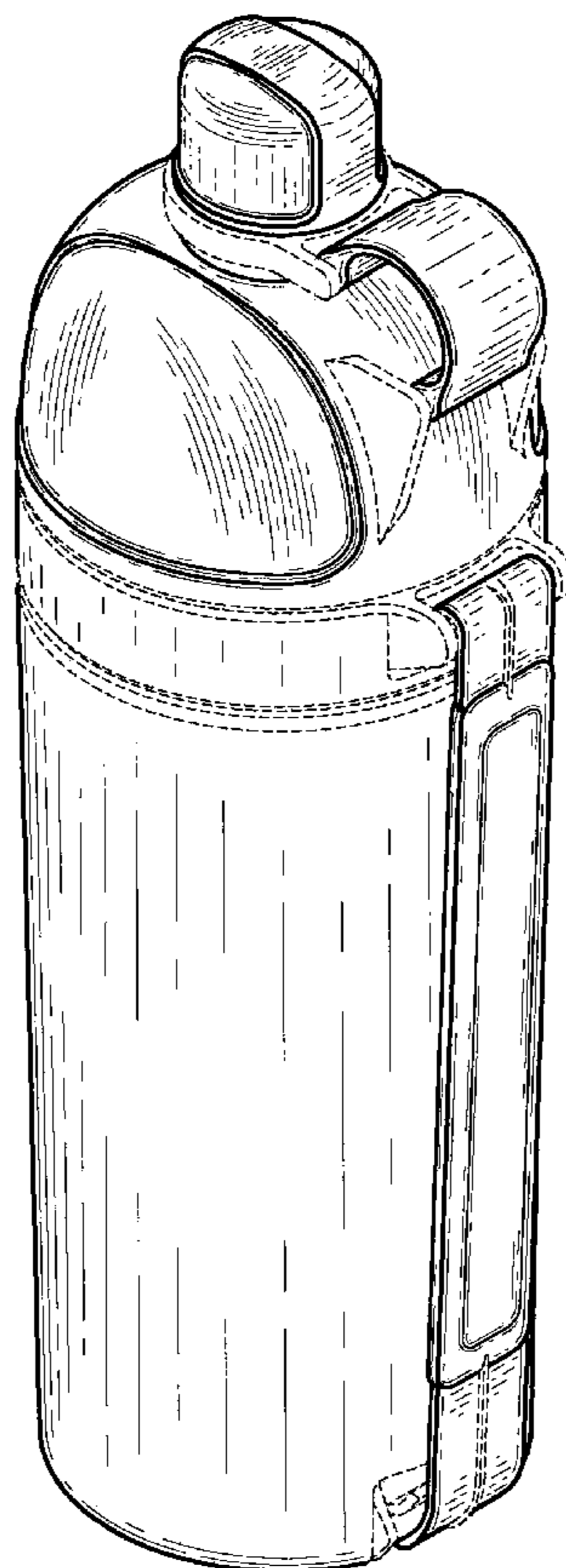

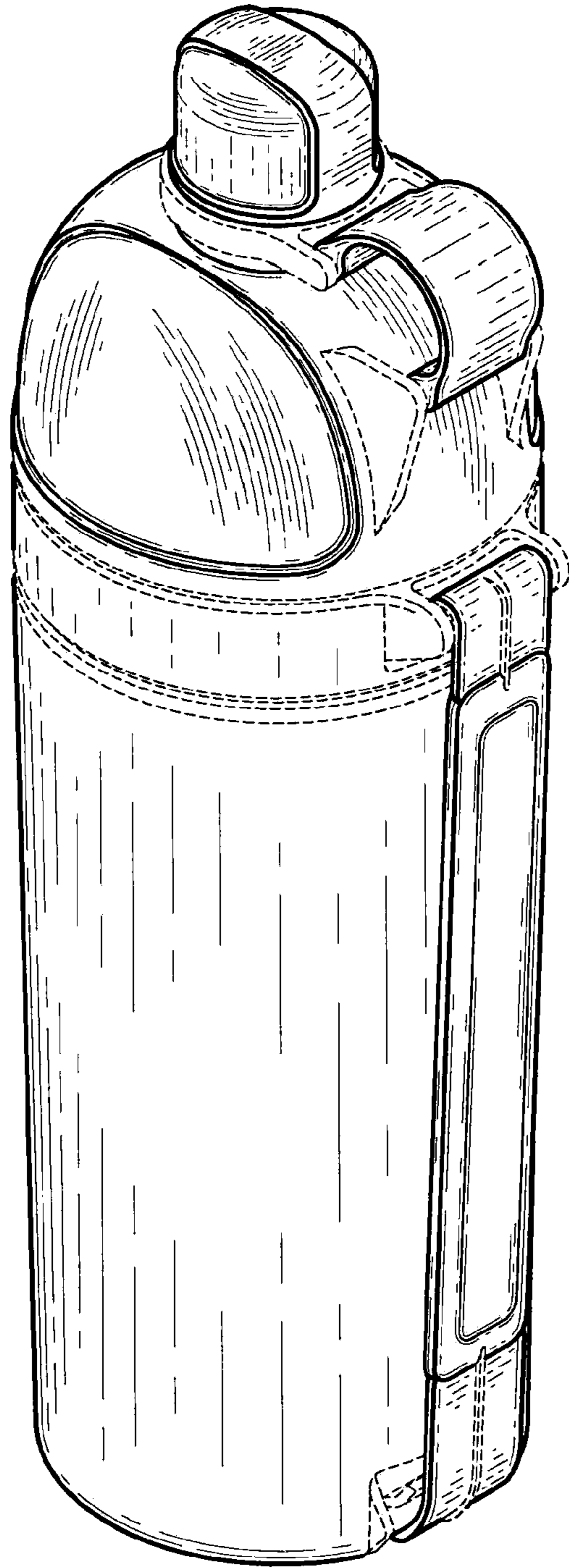

Fig. 1

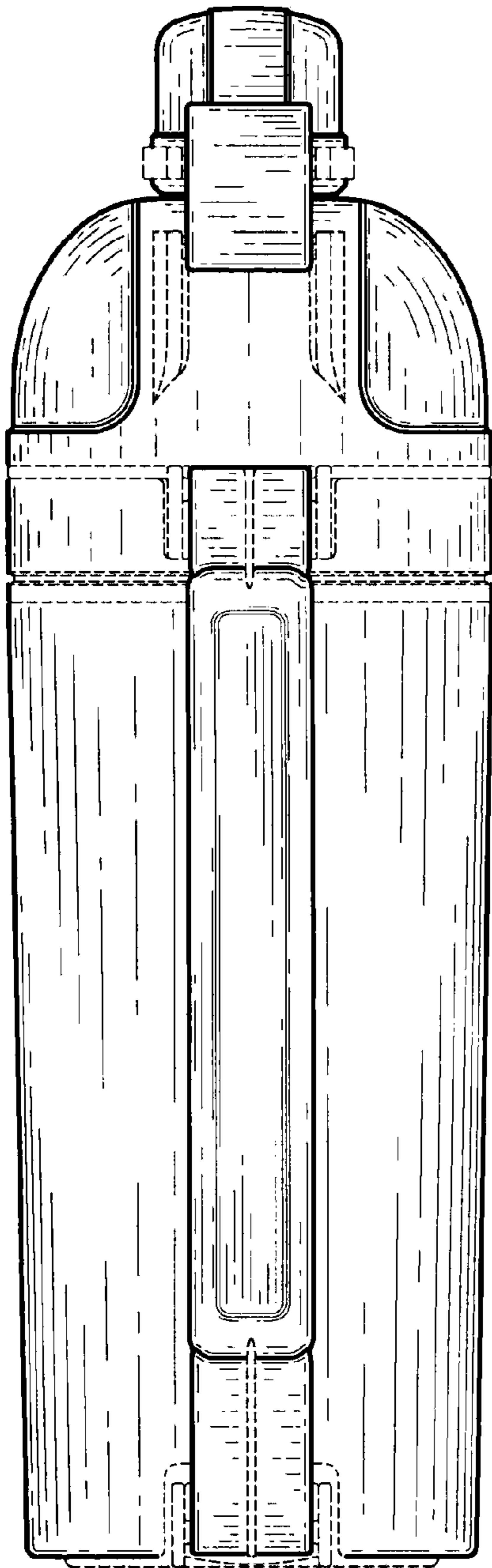

Fig. 2

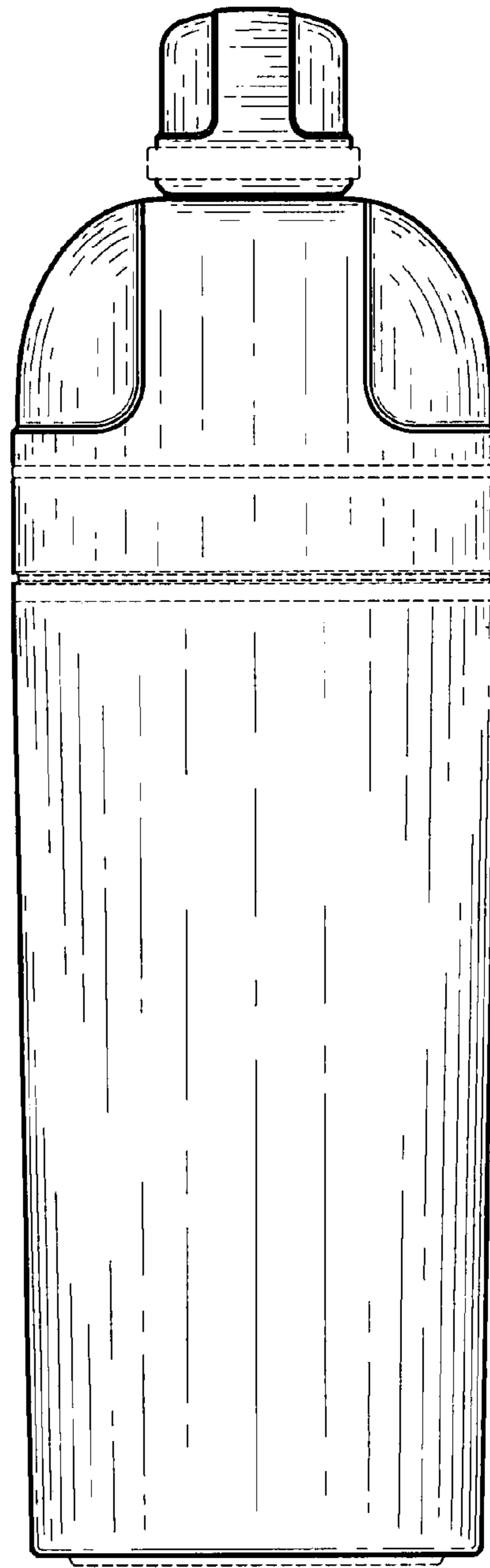

Fig. 3

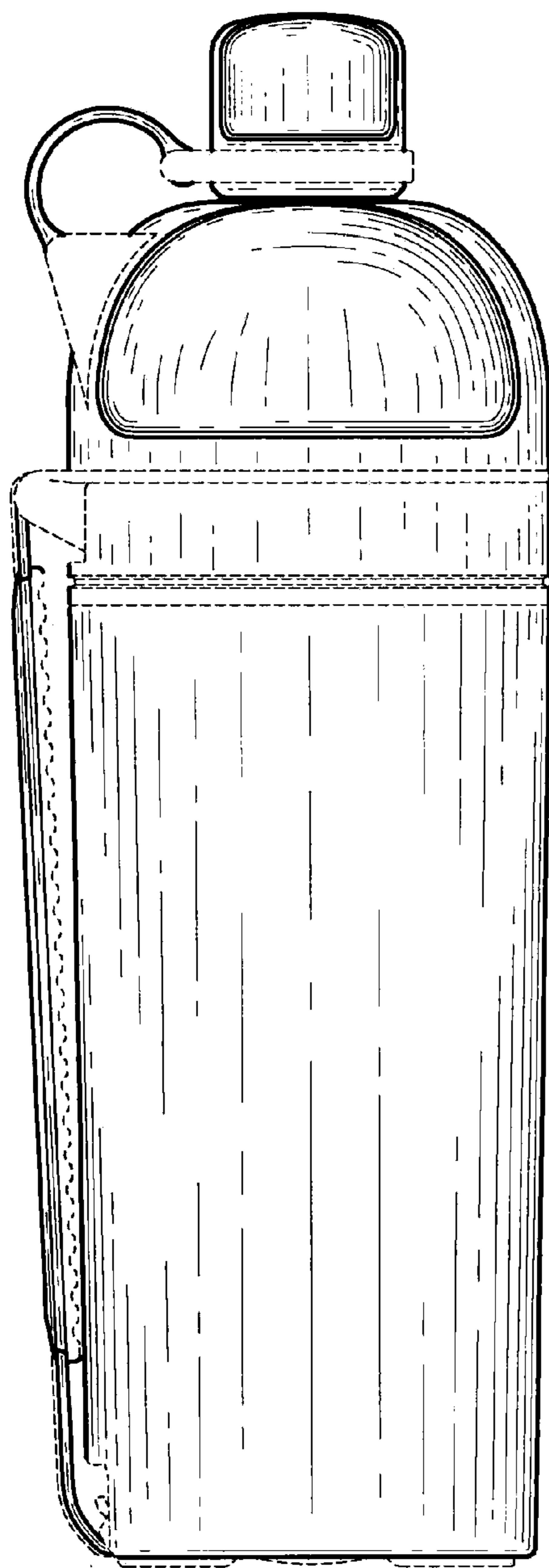

Fig. 4

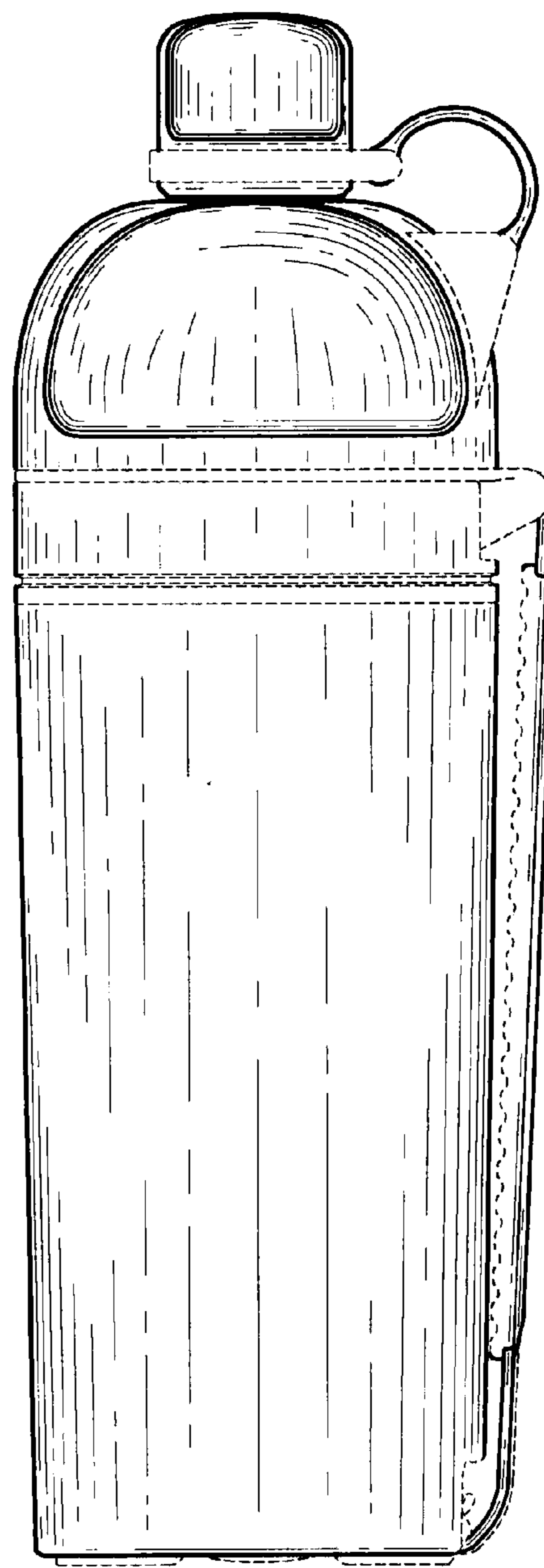

Fig. 5

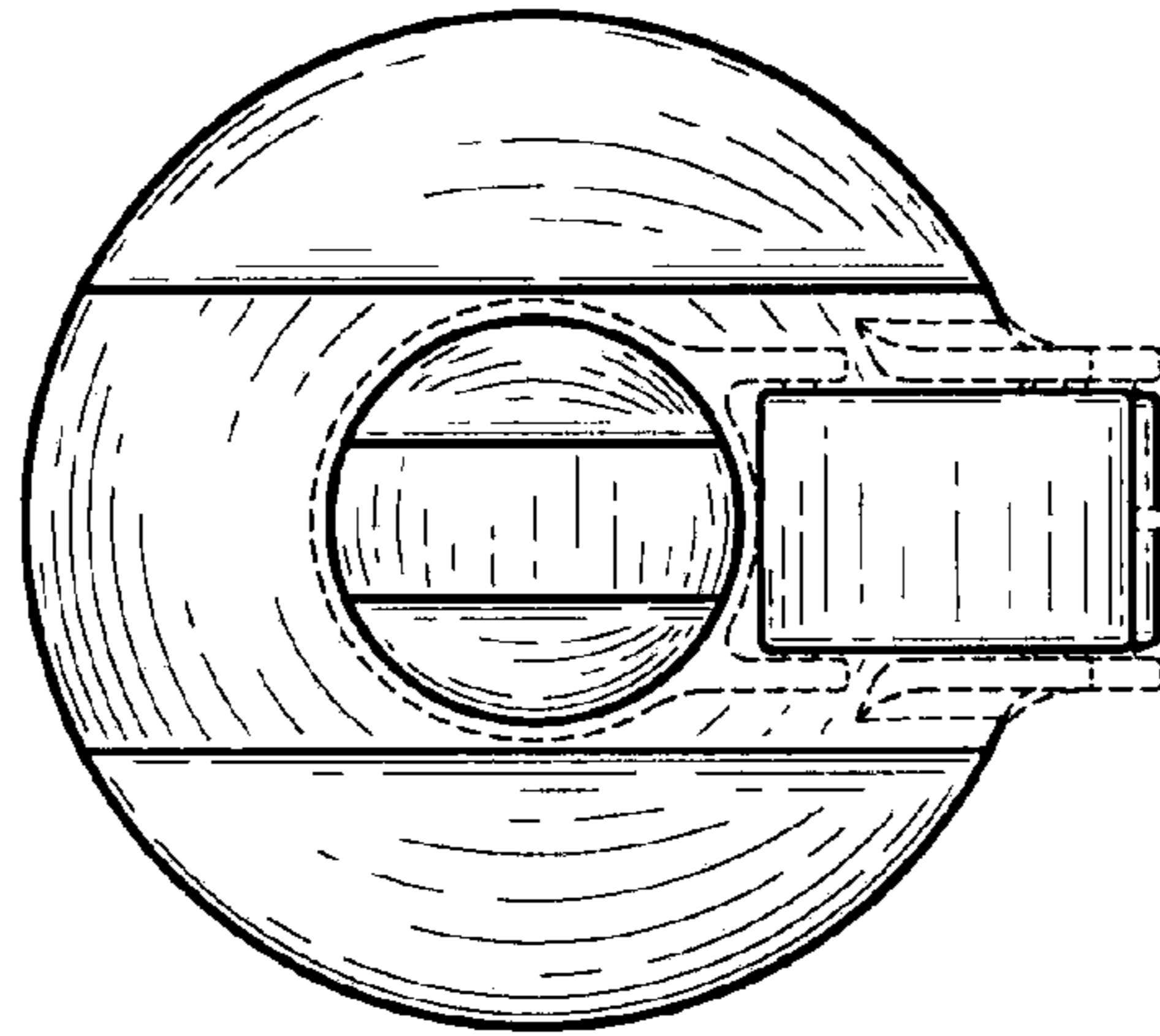

Fig. 6

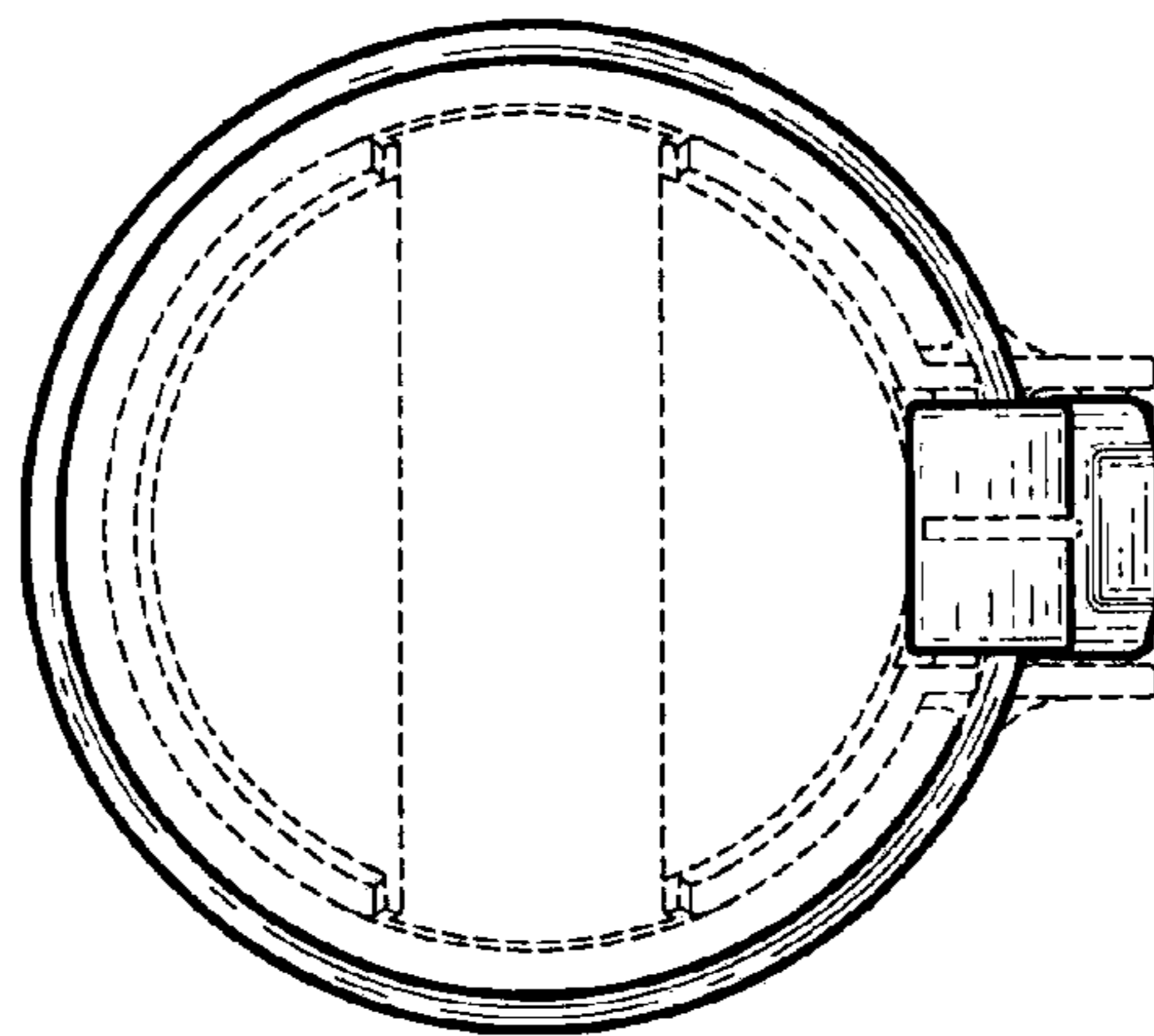

Fig. 7