



US00D660631S

(12) **United States Design Patent**
Romero

(10) **Patent No.:** **US D660,631 S**

(45) **Date of Patent:** **** May 29, 2012**

(54) **SOAP DISPENSER**

(75) Inventor: **Emilie Williams Romero**, Chicago, IL
(US)

(73) Assignee: **Masco Corporation of Indiana**,
Indianapolis, IN (US)

(**) Term: **14 Years**

(21) Appl. No.: **29/389,806**

(22) Filed: **Apr. 18, 2011**

(51) **LOC (9) Cl.** **23-02**

(52) **U.S. Cl.** **D6/542**

(58) **Field of Classification Search** D6/542-545;
D9/682, 688, 690, 291, 448, 449; 221/282;
222/14, 173, 146.3, 628, 251, 181.1, 181.3
See application file for complete search history.

(56) **References Cited**

U.S. PATENT DOCUMENTS

D547,099 S *	7/2007	Williams	D6/542
D559,601 S *	1/2008	Williams	D6/542
D561,510 S *	2/2008	Fritz	D6/542
D622,526 S *	8/2010	Dai	D6/542

* cited by examiner

Primary Examiner — Brian N Vinson

(74) *Attorney, Agent, or Firm* — Edgar A. Zarins; Nirav D. Parikh; Lora J. Graentzdoerffer

(57) **CLAIM**

The ornamental design for a soap dispenser, as shown and described.

DESCRIPTION

FIG. 1 is a perspective view of a soap dispenser showing my new design;
FIG. 2 is a front elevational view thereof;
FIG. 3 is a rear view thereof;
FIG. 4 is a right side view thereof, the opposite side being a mirror image of the side shown;
FIG. 5 is a top plan view thereof; and,
FIG. 6 is a bottom plan view thereof.
The broken-line disclosure in the views is understood to represent portions of the article in which the claimed design is embodied, but which form no part of the claimed design.

1 Claim, 2 Drawing Sheets

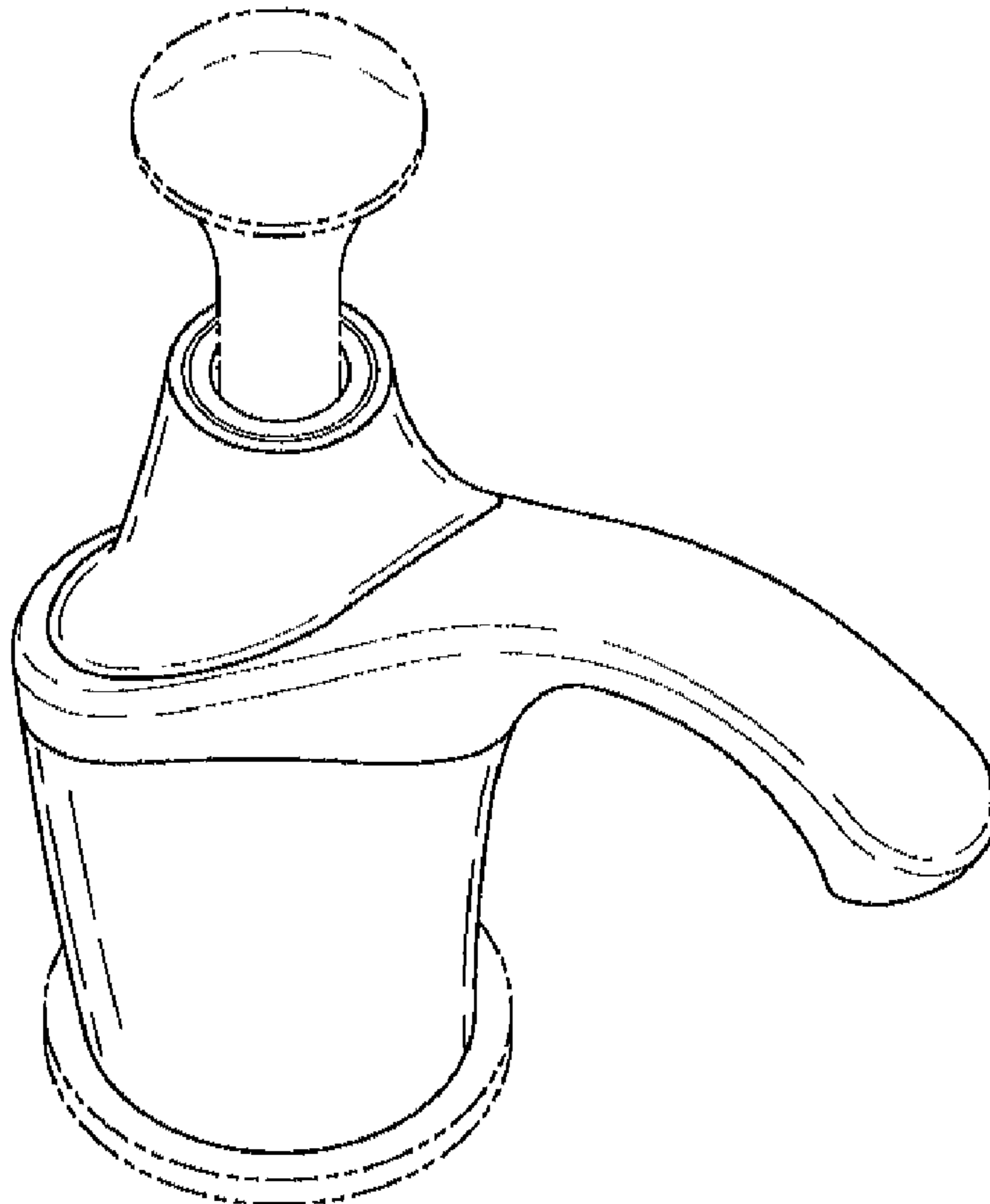

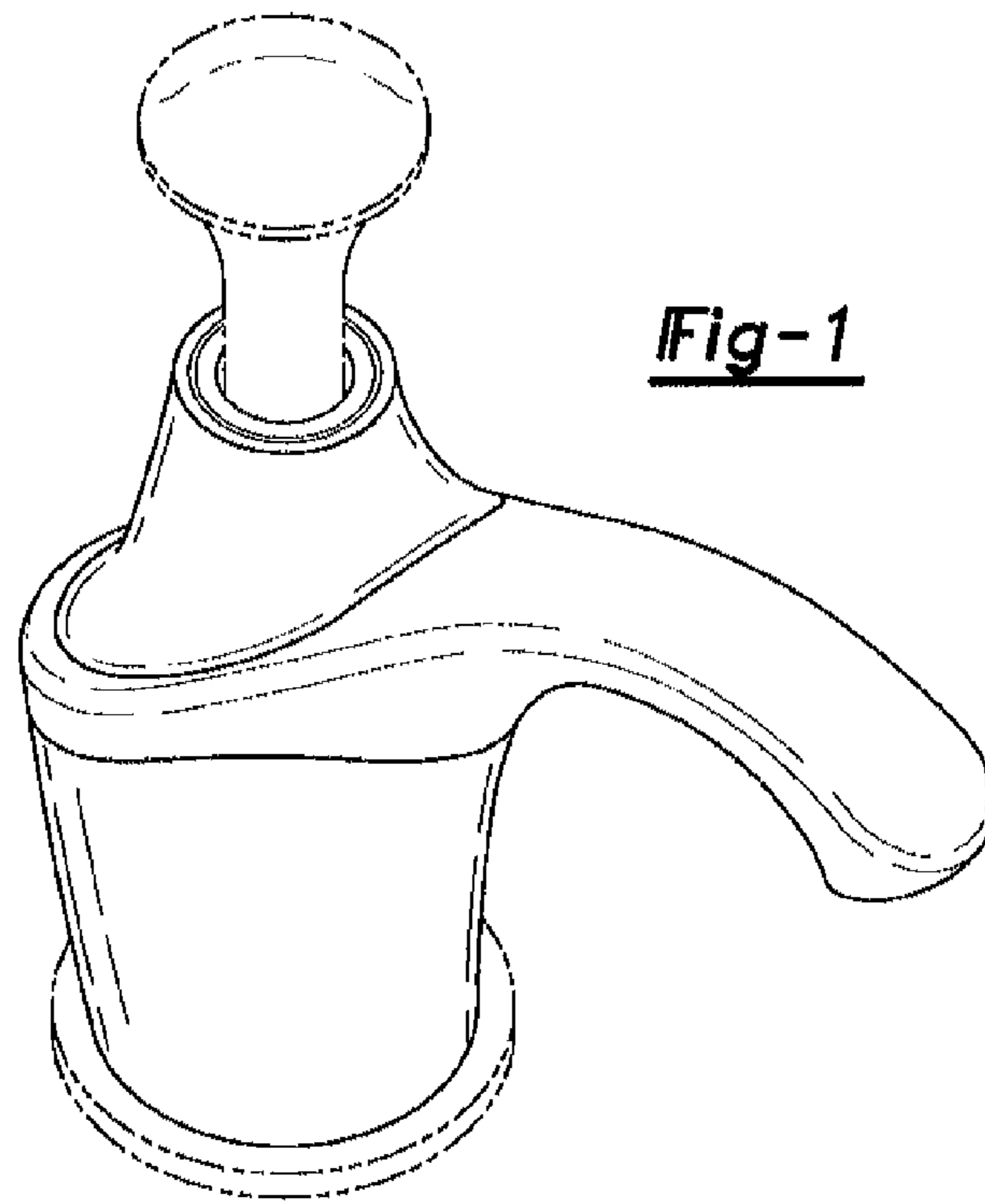

Fig-1

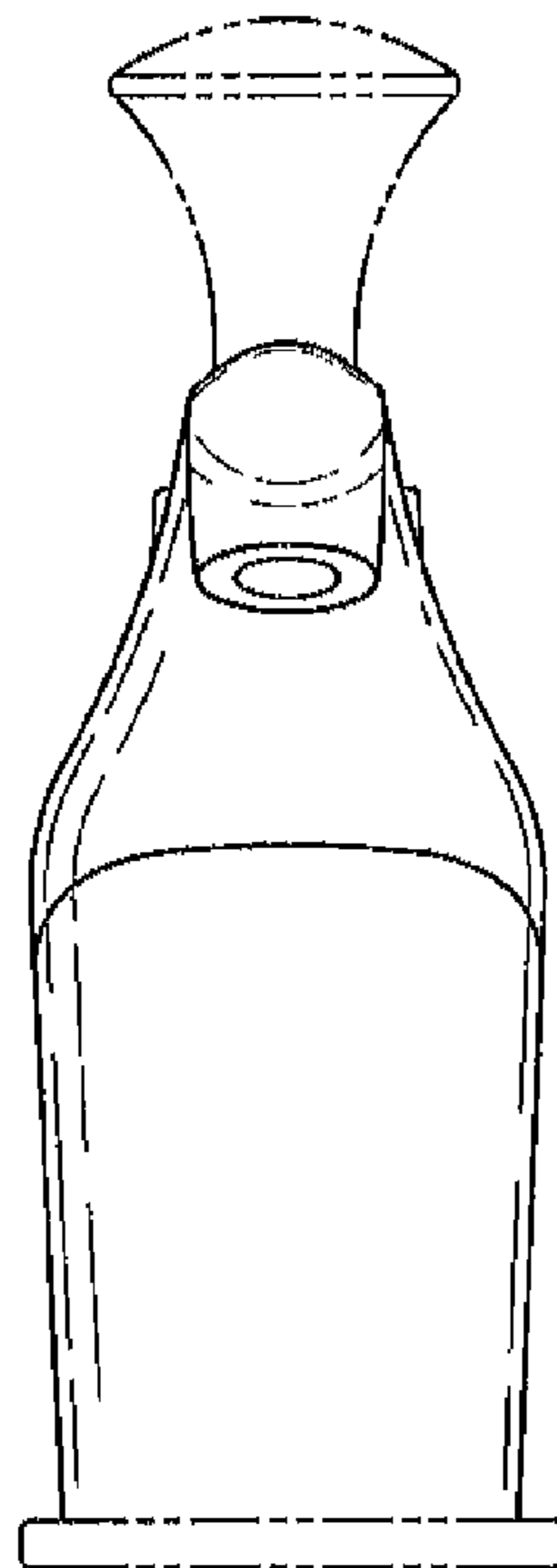

Fig-2

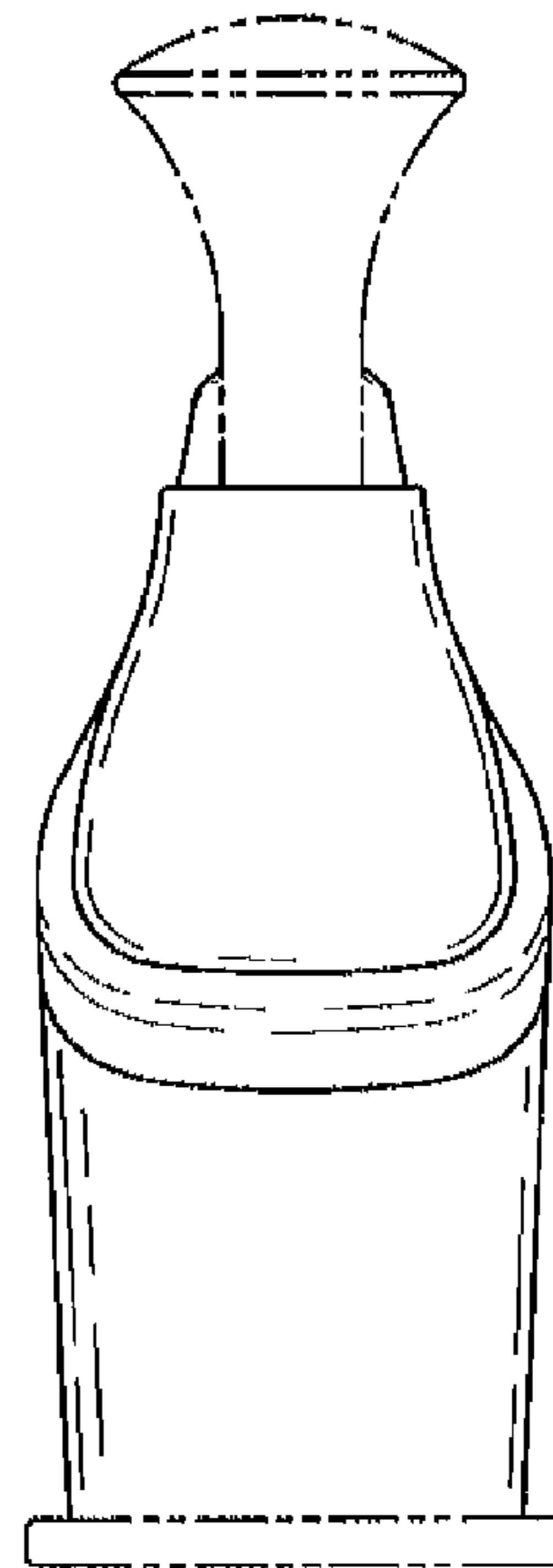

Fig-3

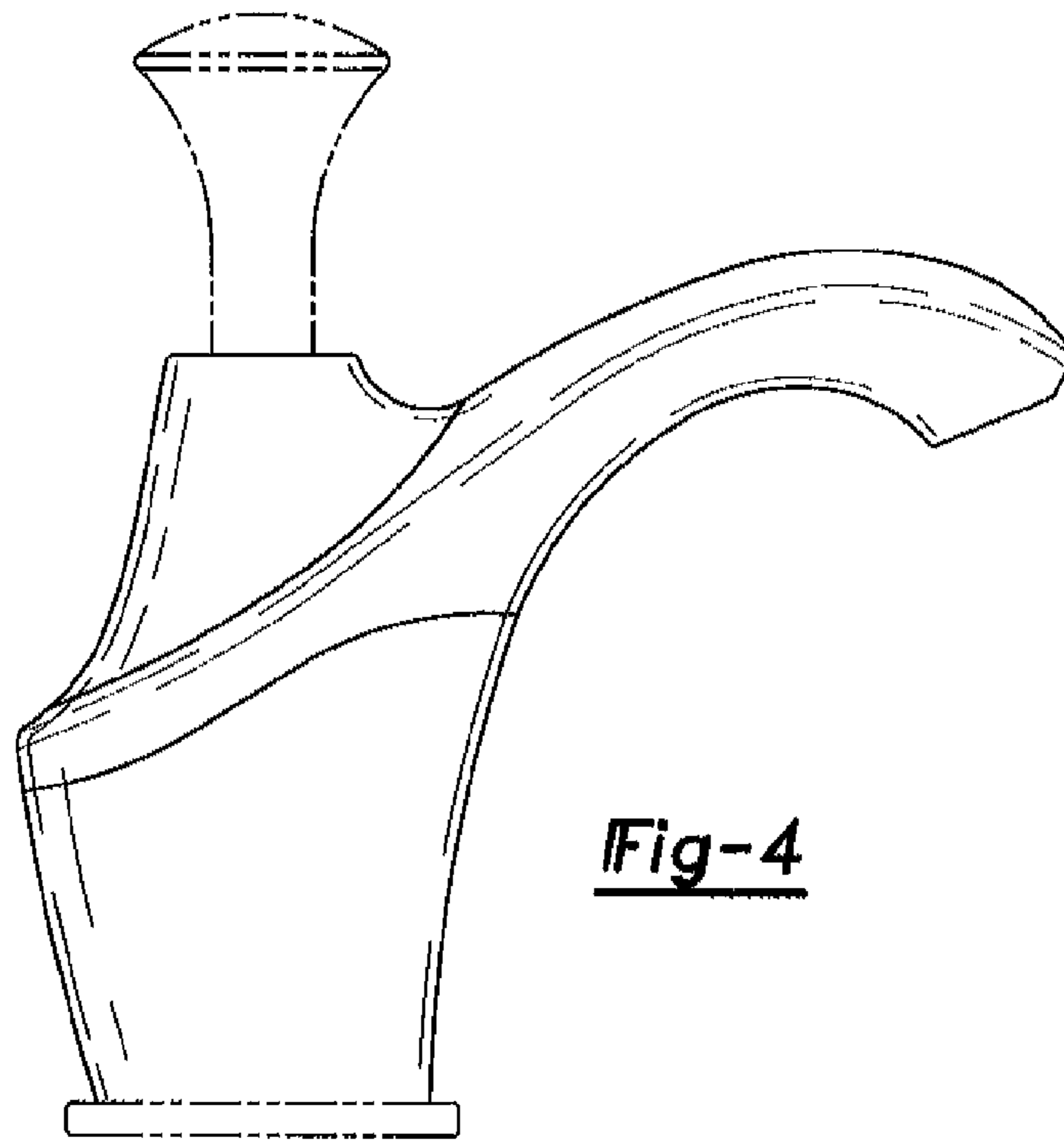

Fig-4

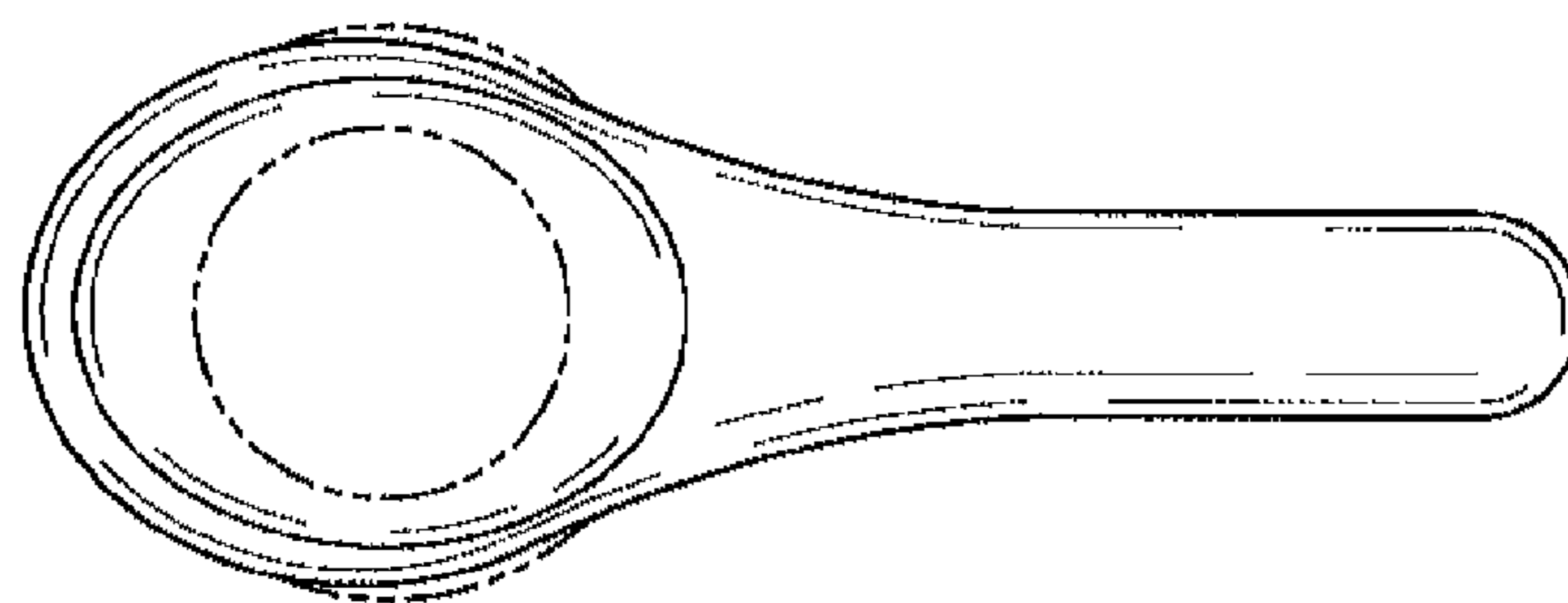

Fig-5

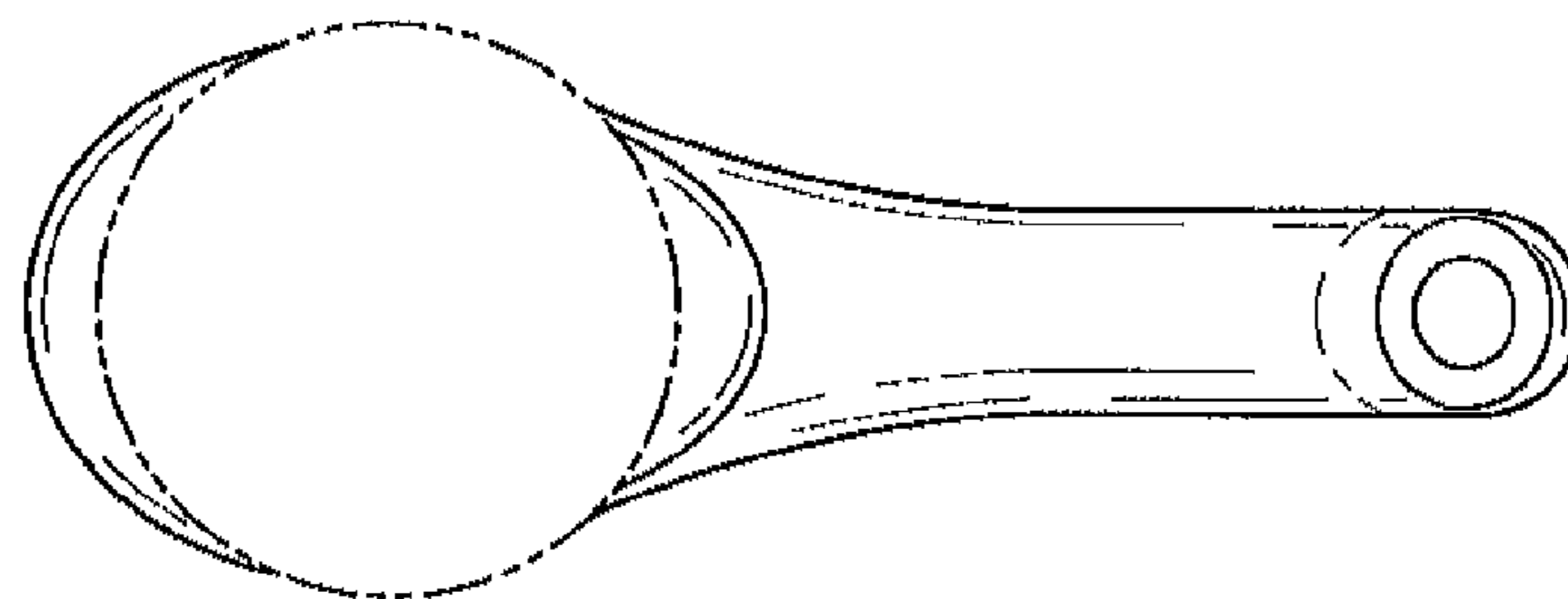

Fig-6