



US00D660528S

(12) **United States Design Patent**
Okuda et al.

(10) **Patent No.:** **US D660,528 S**

(45) **Date of Patent:** **** May 22, 2012**

(54) **ELECTRIC VACUUM CLEANER**

(75) Inventors: **Shinsuke Okuda**, Aichi-ken (JP); **Fuzhi Zhang**, Jiangsu (CN); **Feifei Xiao**, Jiangsu (CN)

(73) Assignee: **Makita Corporation**, Anjo (JP)

(**) Term: **14 Years**

(21) Appl. No.: **29/384,182**

(22) Filed: **Jan. 27, 2011**

(30) **Foreign Application Priority Data**

Jul. 30, 2010 (JP) D2010-018586

(51) **LOC (9) Cl.** **15-05**

(52) **U.S. Cl.** **D32/18**

(58) **Field of Classification Search** D32/17-18,
D32/22, 31; 15/320-321, 350-354, 415.1-422,
15/329, 344, 361, 410-411, 347, 1.7, DIG. 1;
55/DIG. 3

See application file for complete search history.

(56) **References Cited**

U.S. PATENT DOCUMENTS

D294,412 S *	2/1988	Sadashima et al.	D32/18
D302,876 S *	8/1989	Ikeda et al.	D32/18
D401,021 S *	11/1998	Stephens et al.	D32/18
D456,960 S *	5/2002	Vandenbelt et al.	D32/18
D489,849 S *	5/2004	Ki	D32/18

D506,297 S *	6/2005	Buzzi	D32/17
D507,385 S *	7/2005	Ma	D32/18
D565,812 S *	4/2008	Fjellman	D32/18
D569,059 S *	5/2008	Stratford	D32/18
D569,060 S *	5/2008	Stratford	D32/18
D579,161 S *	10/2008	Crawley	D32/18
D608,063 S *	1/2010	Okuda et al.	D32/18
D608,511 S *	1/2010	Okuda et al.	D32/18
D640,021 S *	6/2011	Houghton	D32/18
D653,008 S *	1/2012	Houghton	D32/18
2012/0030897 A1 *	2/2012	Crouch	15/344

* cited by examiner

Primary Examiner — Ruth McInroy

(74) *Attorney, Agent, or Firm* — Oliff & Berridge, PLC

(57) **CLAIM**

The ornamental design for an electric vacuum cleaner, as shown and described.

DESCRIPTION

FIG. 1 is a perspective view of the front, top and left side of an electric vacuum cleaner showing our new design;

FIG. 2 is a front view thereof;

FIG. 3 is a rear view thereof;

FIG. 4 is a top plan view thereof;

FIG. 5 is a bottom view thereof;

FIG. 6 is a left side view thereof; and,

FIG. 7 is a right side view thereof.

The portions shown in broken lines are for illustrative purposes only and form no part of the claimed design.

1 Claim, 6 Drawing Sheets

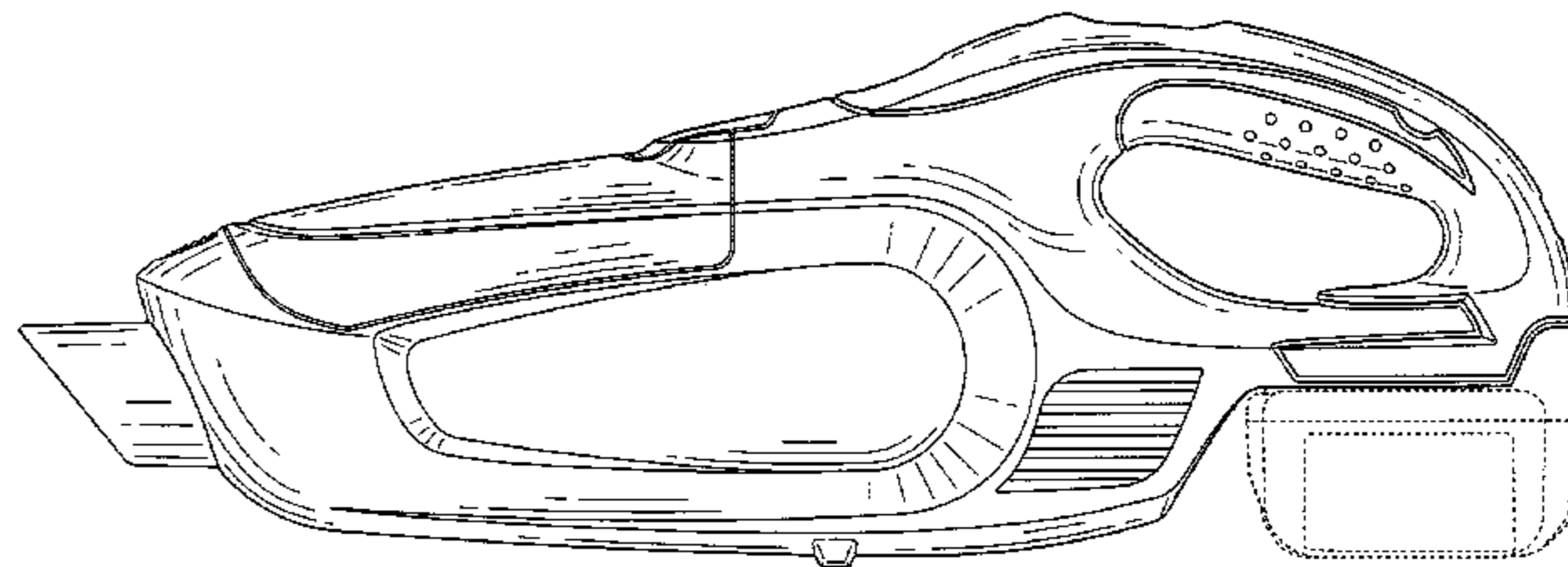
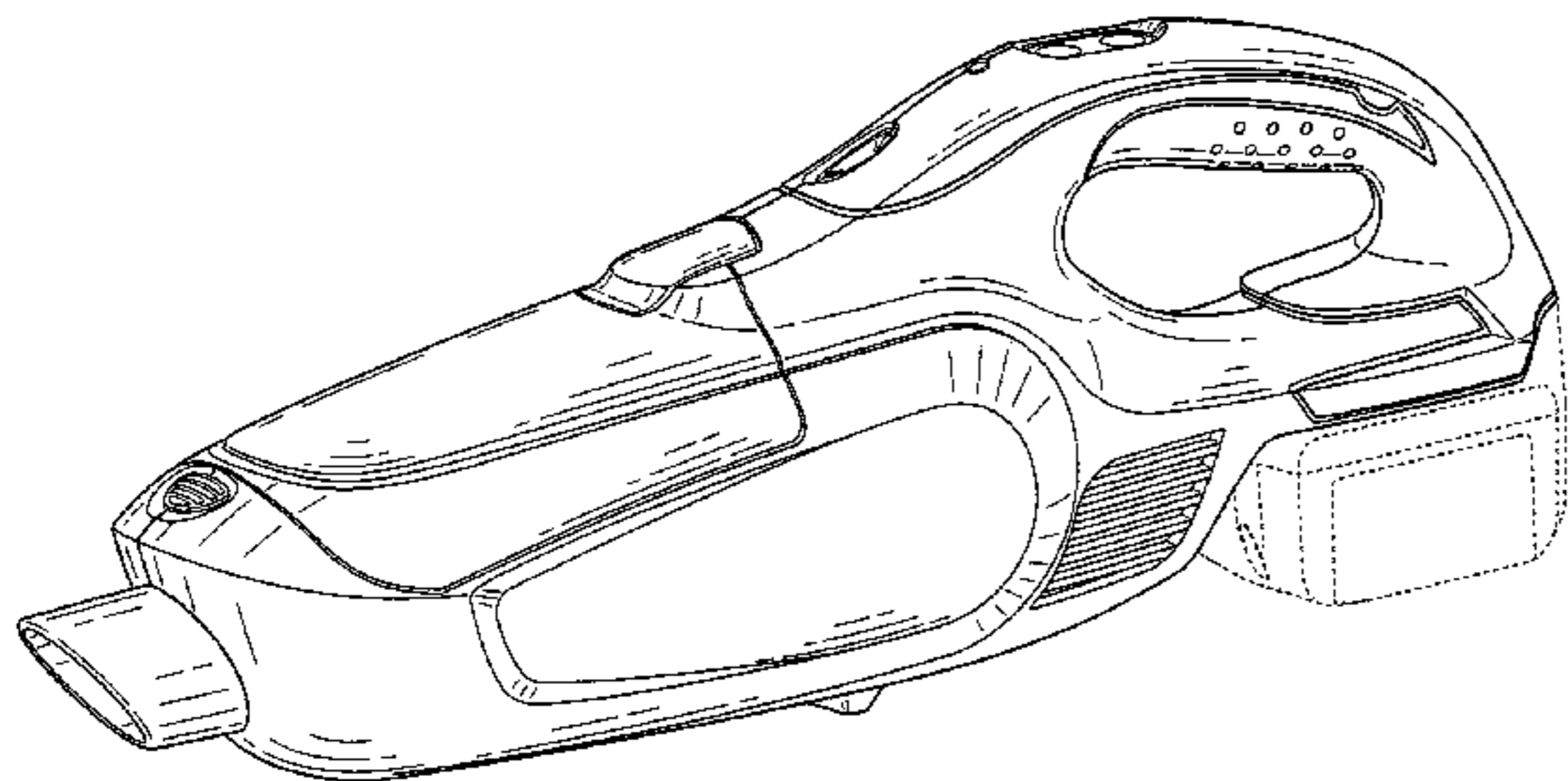

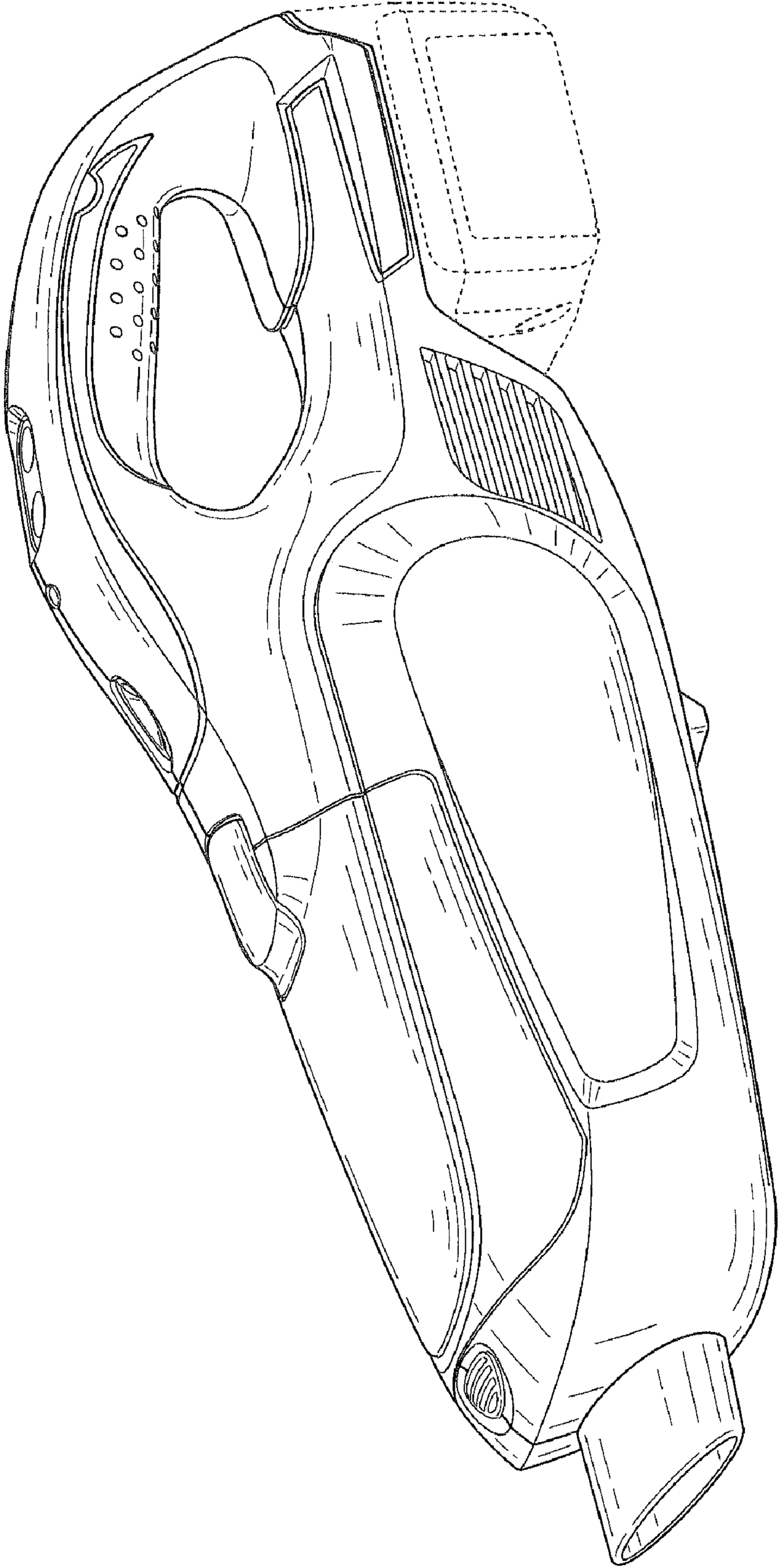

FIG. 1

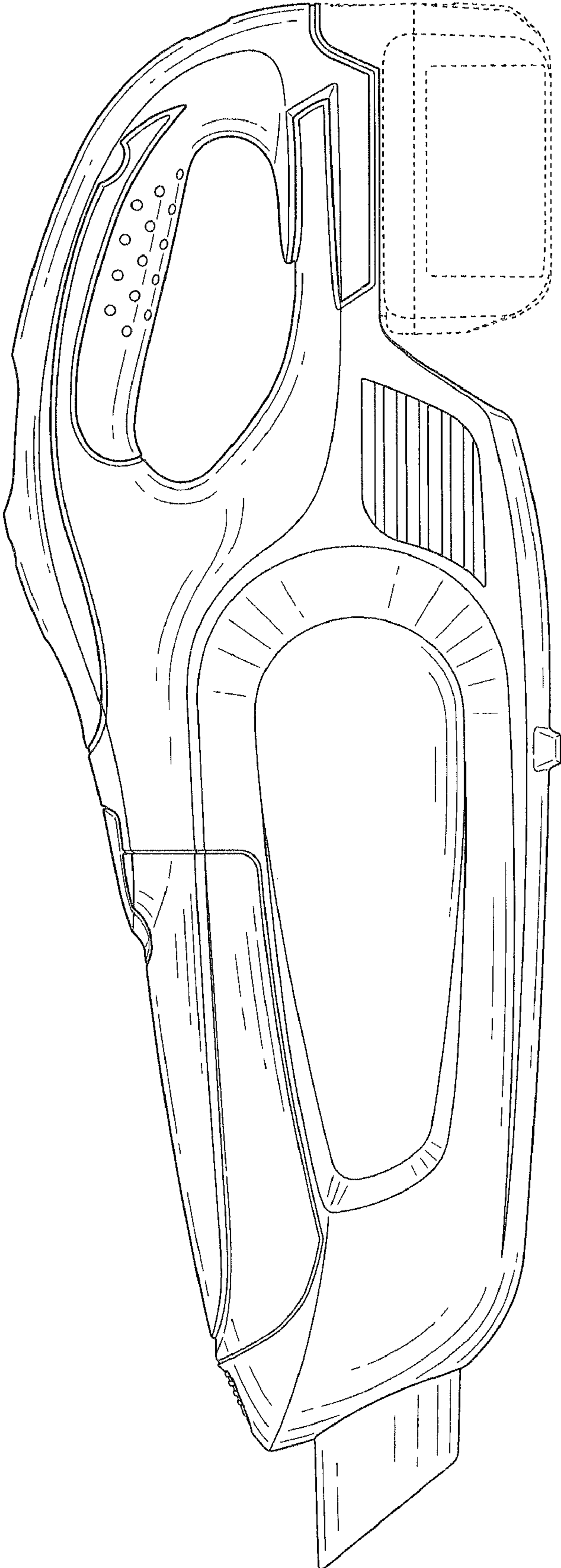

FIG. 2

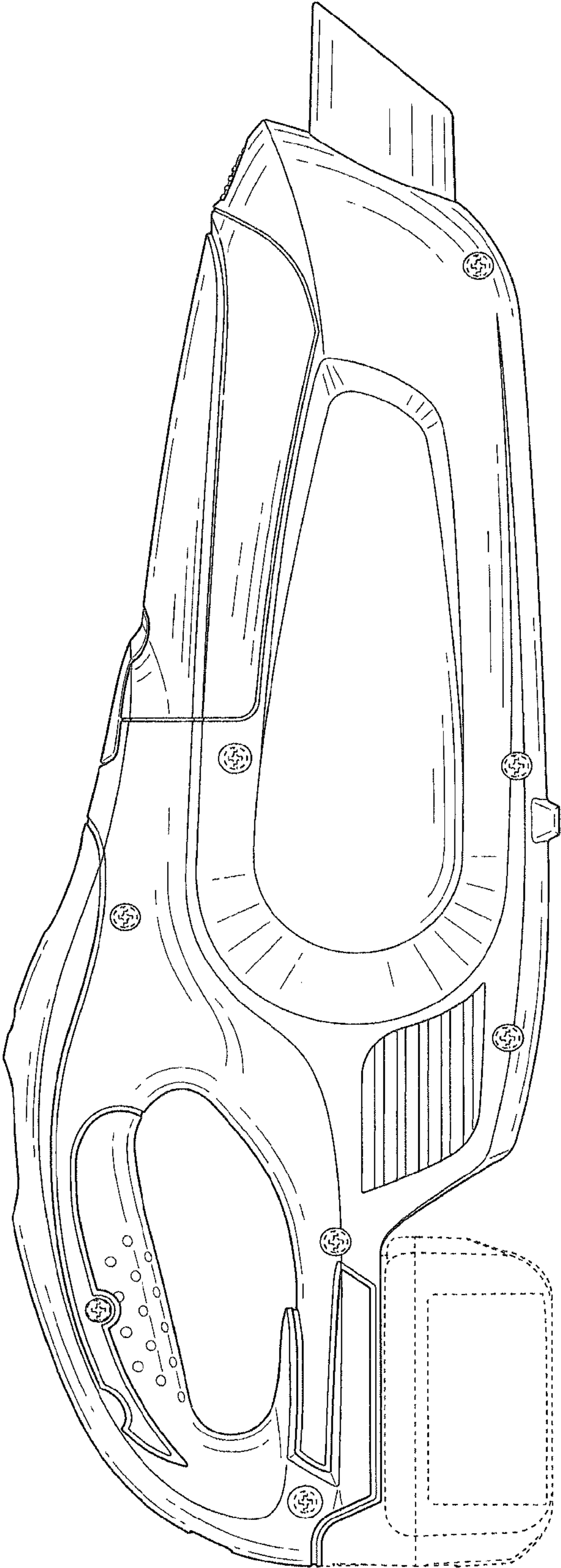

FIG. 3

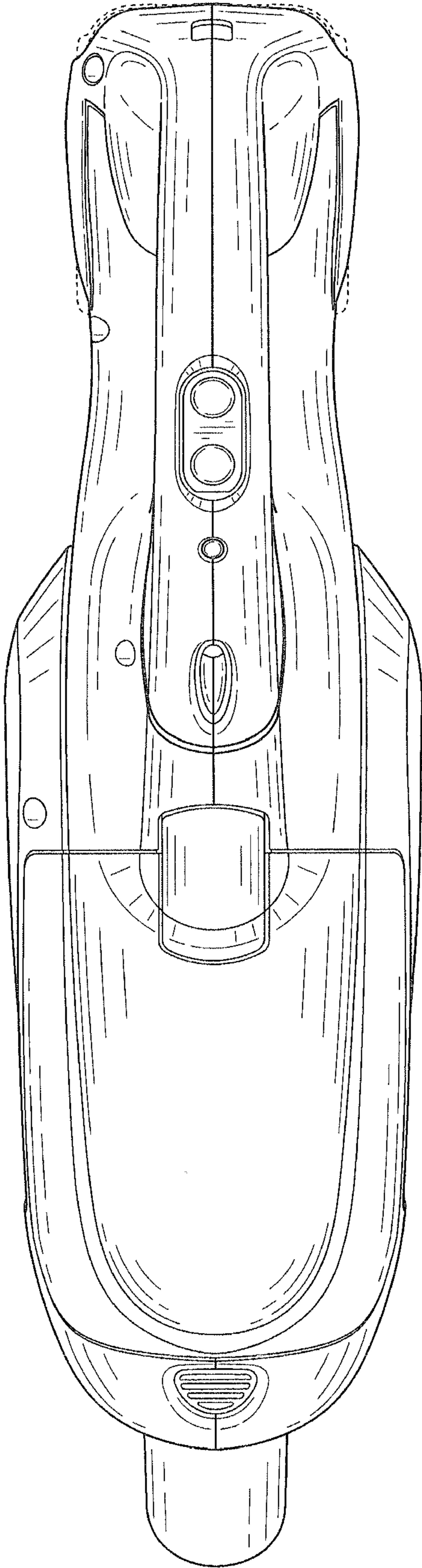

FIG. 4

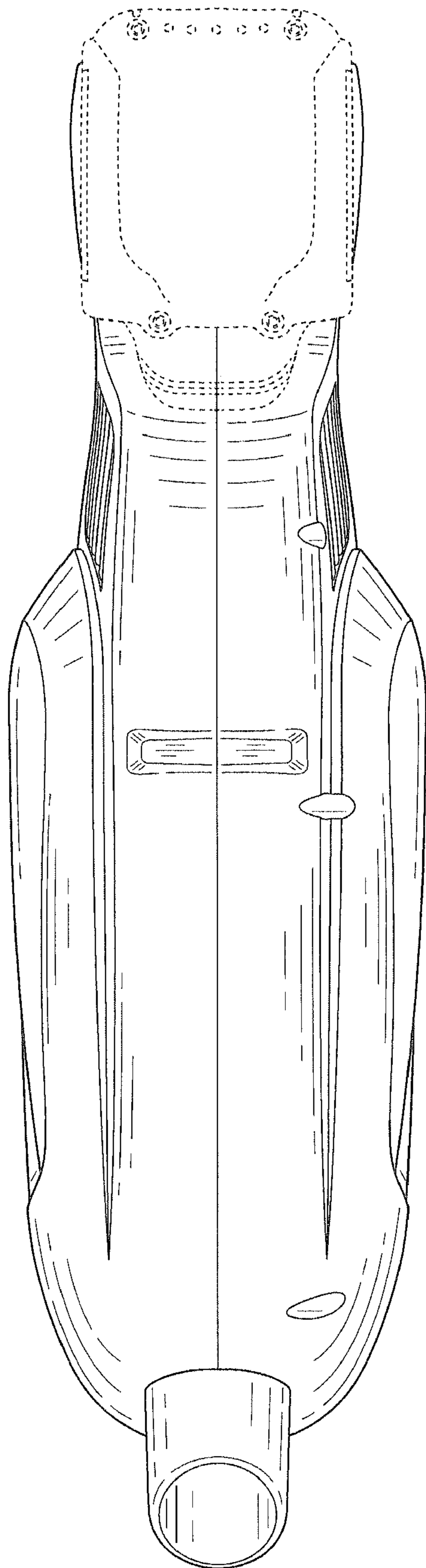

FIG. 5

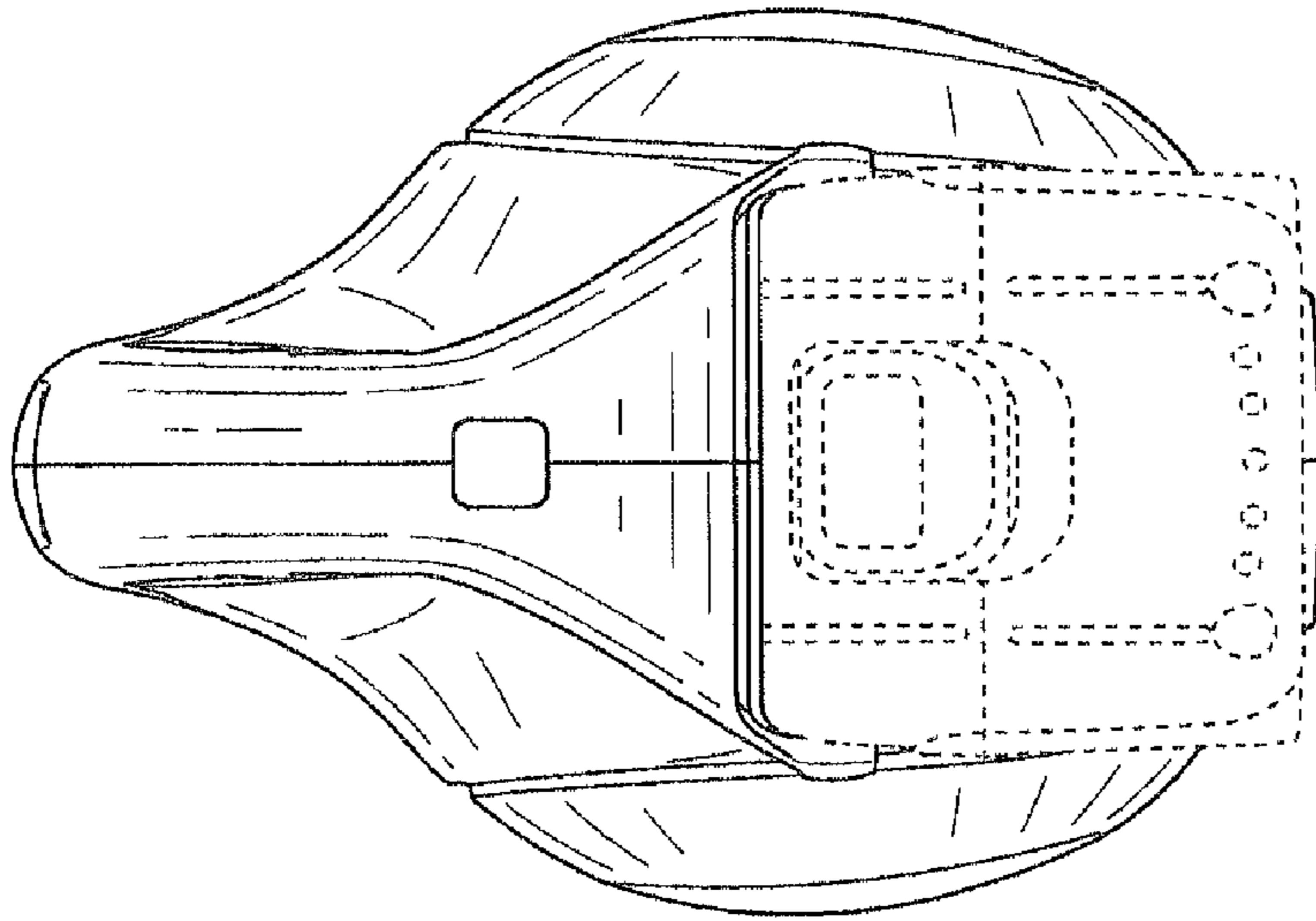

FIG. 7

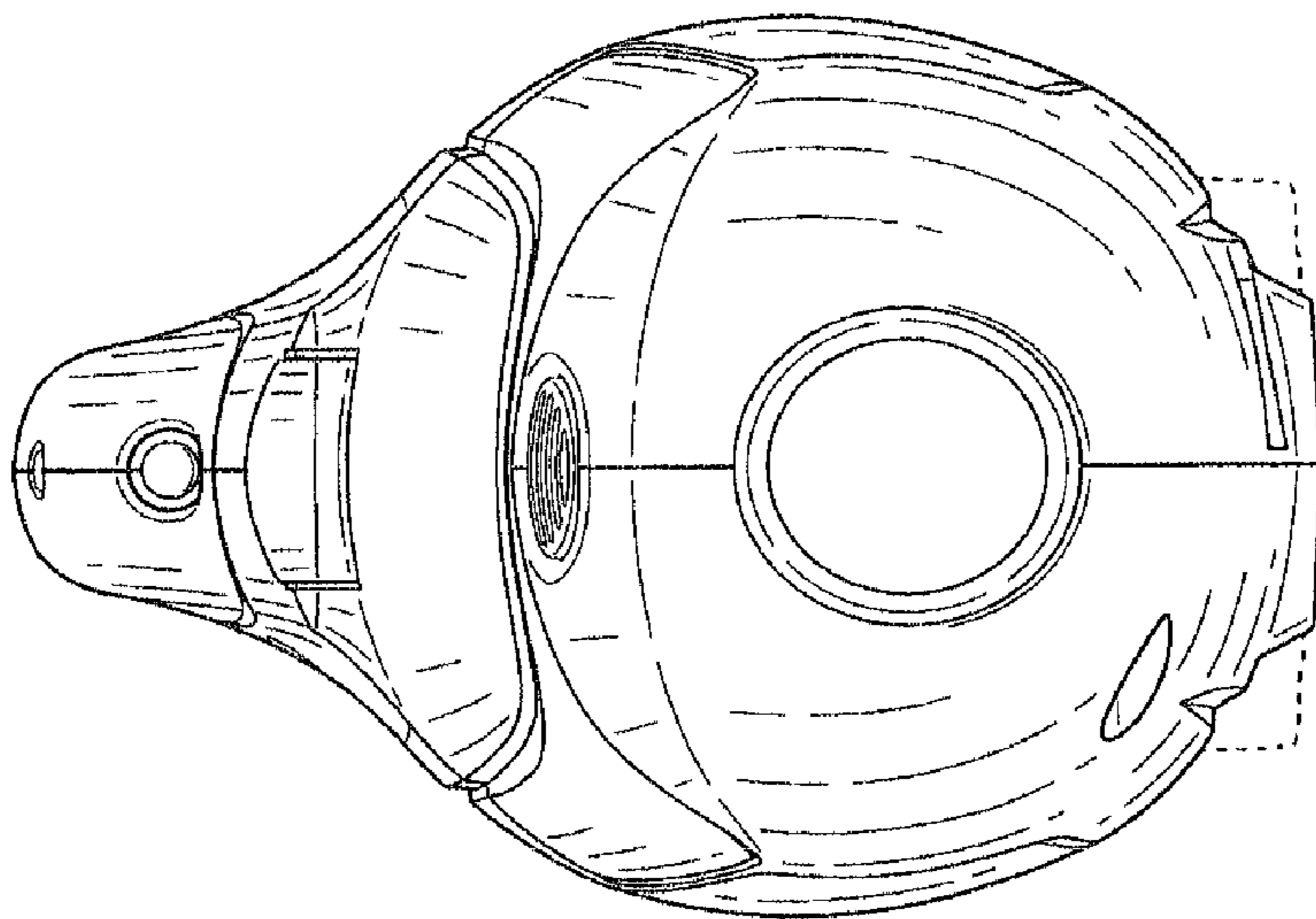

FIG. 6