



US00D660423S

(12) **United States Design Patent**  
**Hermle**

(10) **Patent No.:** **US D660,423 S**

(45) **Date of Patent:** **\*\* May 22, 2012**

- (54) **TUBE FOR THYROID SURGERY**
- (75) Inventor: **Rainer Hermle**, Gosheim (DE)
- (73) Assignee: **Karl Storz GmbH & Co. KG** (DE)
- (\*\*) Term: **14 Years**
- (21) Appl. No.: **29/396,193**
- (22) Filed: **Jun. 27, 2011**

- D570,479 S \* 6/2008 Rehbein et al. .... D24/133
- D570,480 S \* 6/2008 Rehbein et al. .... D24/133
- D570,481 S \* 6/2008 Rehbein et al. .... D24/133
- D606,193 S \* 12/2009 Oberlaender et al. .... D24/146
- 2003/0045834 A1 \* 3/2003 Wing et al. .... 604/161
- 2005/0261714 A1 \* 11/2005 McCartney ..... 606/167

\* cited by examiner

*Primary Examiner* — Bridget L Eland  
(74) *Attorney, Agent, or Firm* — St. Onge Steward Johnston & Reens LLC

- (30) **Foreign Application Priority Data**
- Dec. 27, 2010 (EM) ..... 001798695-0001
- (51) **LOC (9) Cl.** ..... **24-02**
- (52) **U.S. Cl.** ..... **D24/133**
- (58) **Field of Classification Search** ..... D24/133,  
D24/137, 138, 140, 112; 600/104, 114; 604/19,  
604/35, 22, 317, 319, 264; 606/1, 107, 130,  
606/323, 190  
See application file for complete search history.

(57) **CLAIM**  
The ornamental design for a tube for thyroid surgery, as shown and described.

**DESCRIPTION**

FIG. 1 is a rear left side perspective view of a tube for thyroid surgery in accordance with the new design; FIG. 2 is a left side isometric view thereof; FIG. 3 is a top isometric view thereof; FIG. 4 is a right side isometric view thereof; FIG. 5 is a bottom isometric view thereof; FIG. 6 is a front isometric view thereof; and, FIG. 7 is a rear isometric view thereof. The broken lines adjacent the shaded areas in FIGS. 1-4, 6 and 7 represent bounds of the claimed design, with lines themselves and the areas within them forming no part of the claimed design.

- (56) **References Cited**
- U.S. PATENT DOCUMENTS
- D362,066 S \* 9/1995 Petruschke et al. .... D24/146
- 5,456,673 A \* 10/1995 Ziegler et al. .... 604/264
- 5,843,039 A \* 12/1998 Klemm ..... 604/164.01
- D434,148 S \* 11/2000 Sauer et al. .... D24/146
- 6,945,983 B2 \* 9/2005 Dittrich et al. .... 606/185
- D559,980 S \* 1/2008 Rehbein et al. .... D24/133

**1 Claim, 5 Drawing Sheets**

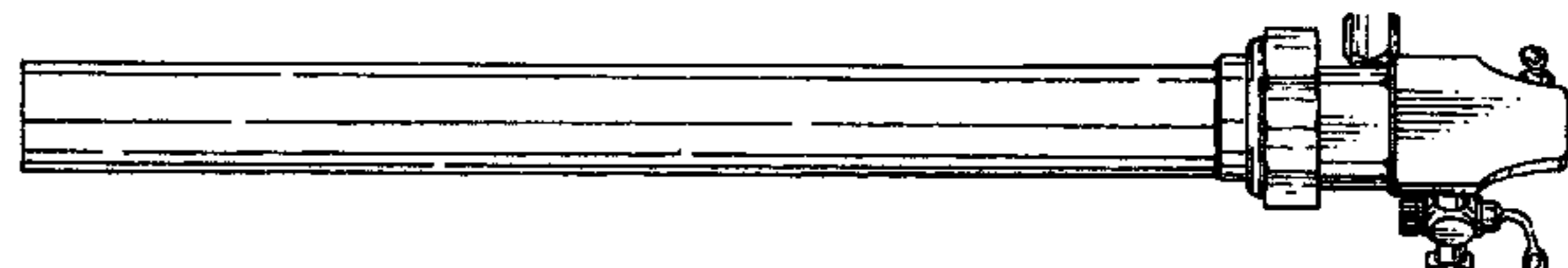
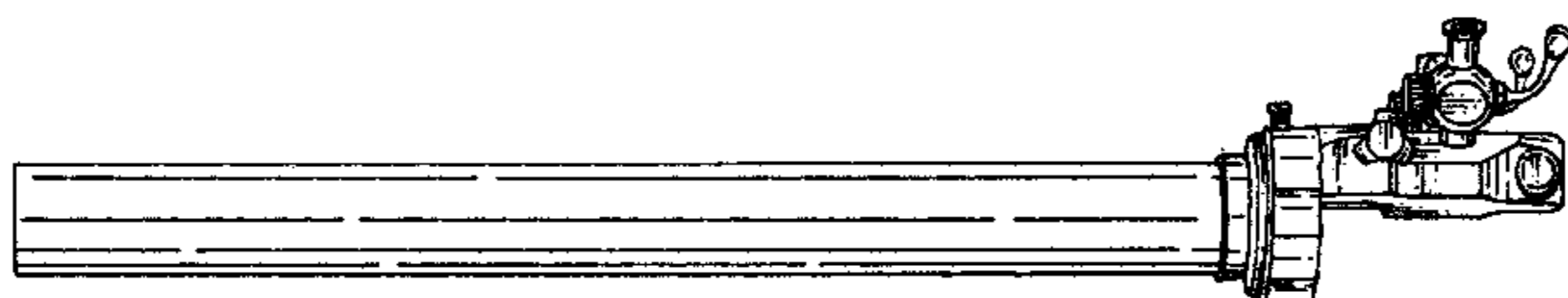

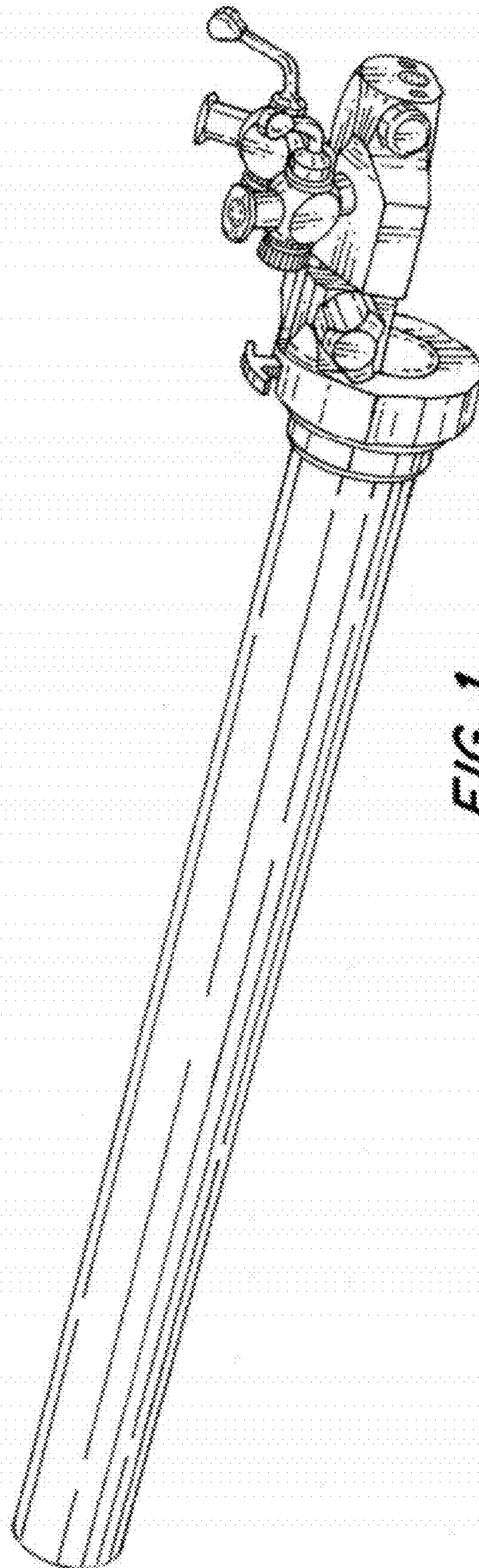

FIG. 1



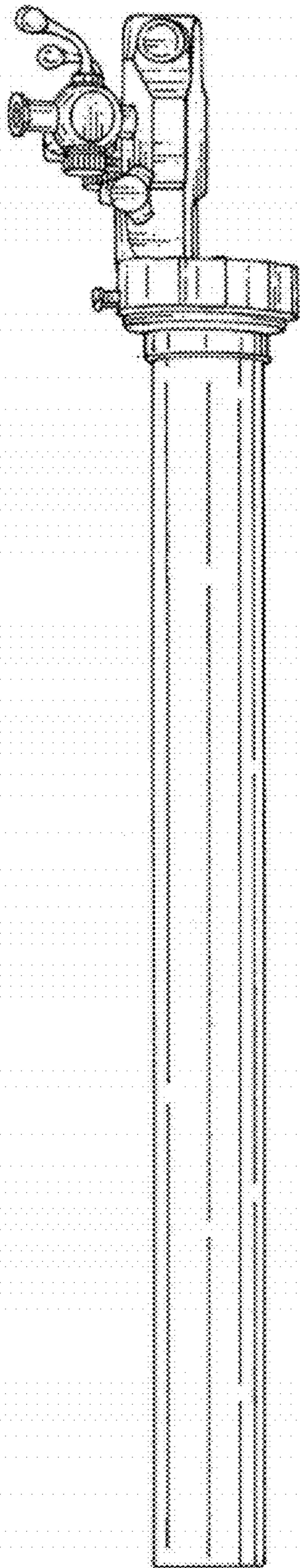

FIG. 2

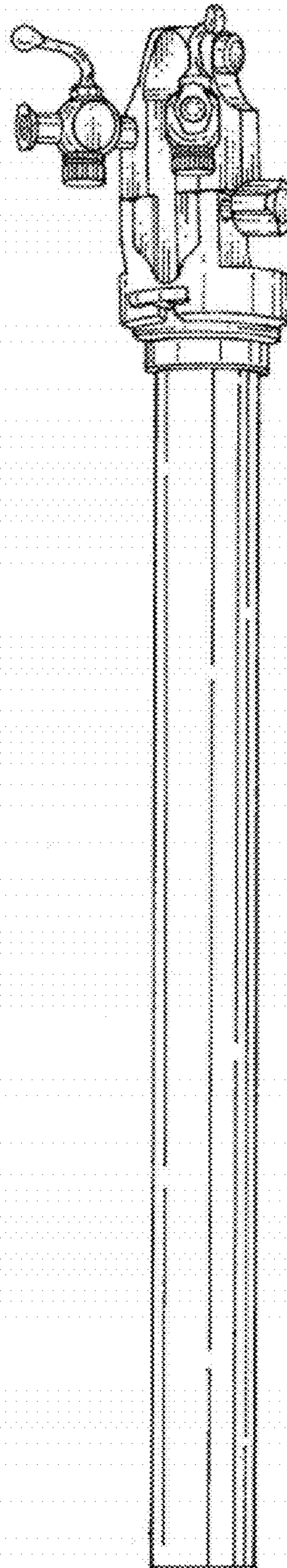
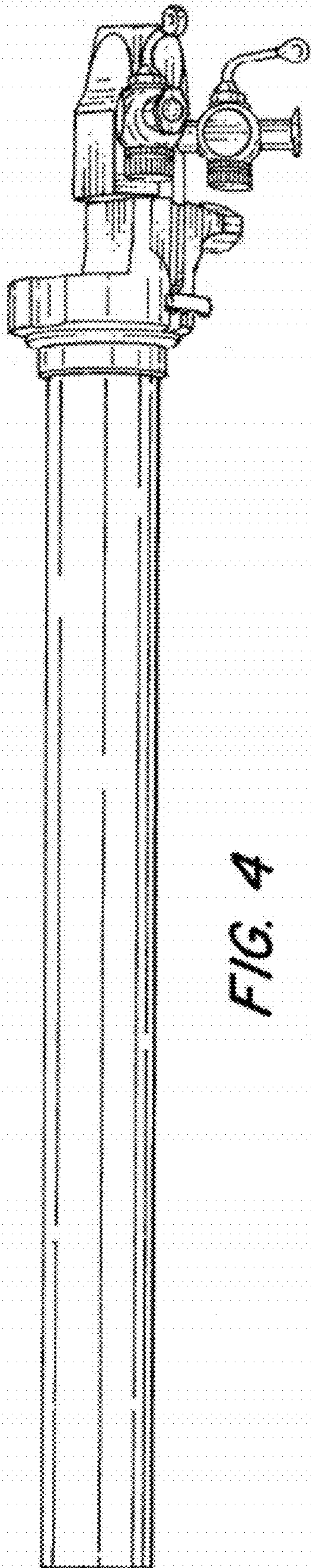
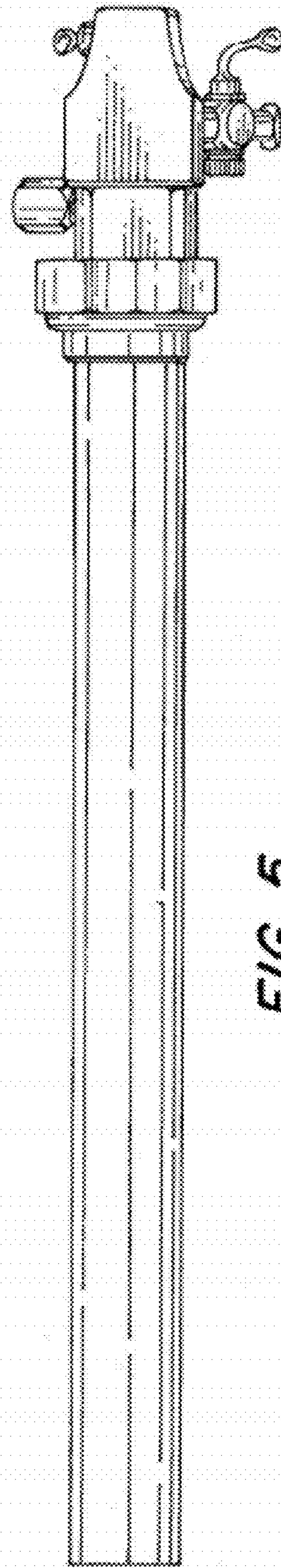

FIG. 3

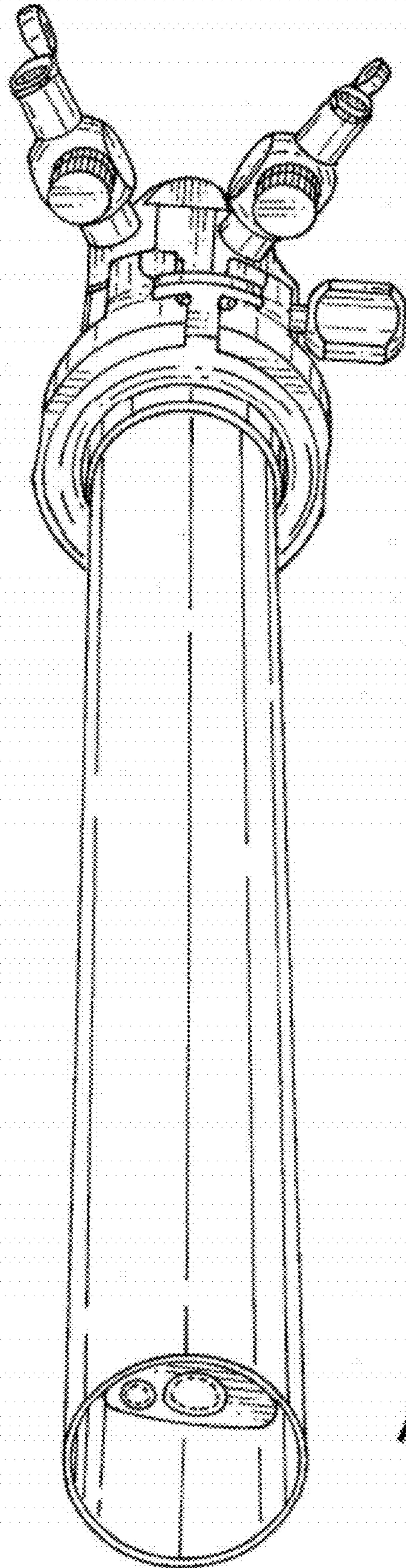

*FIG. 4*

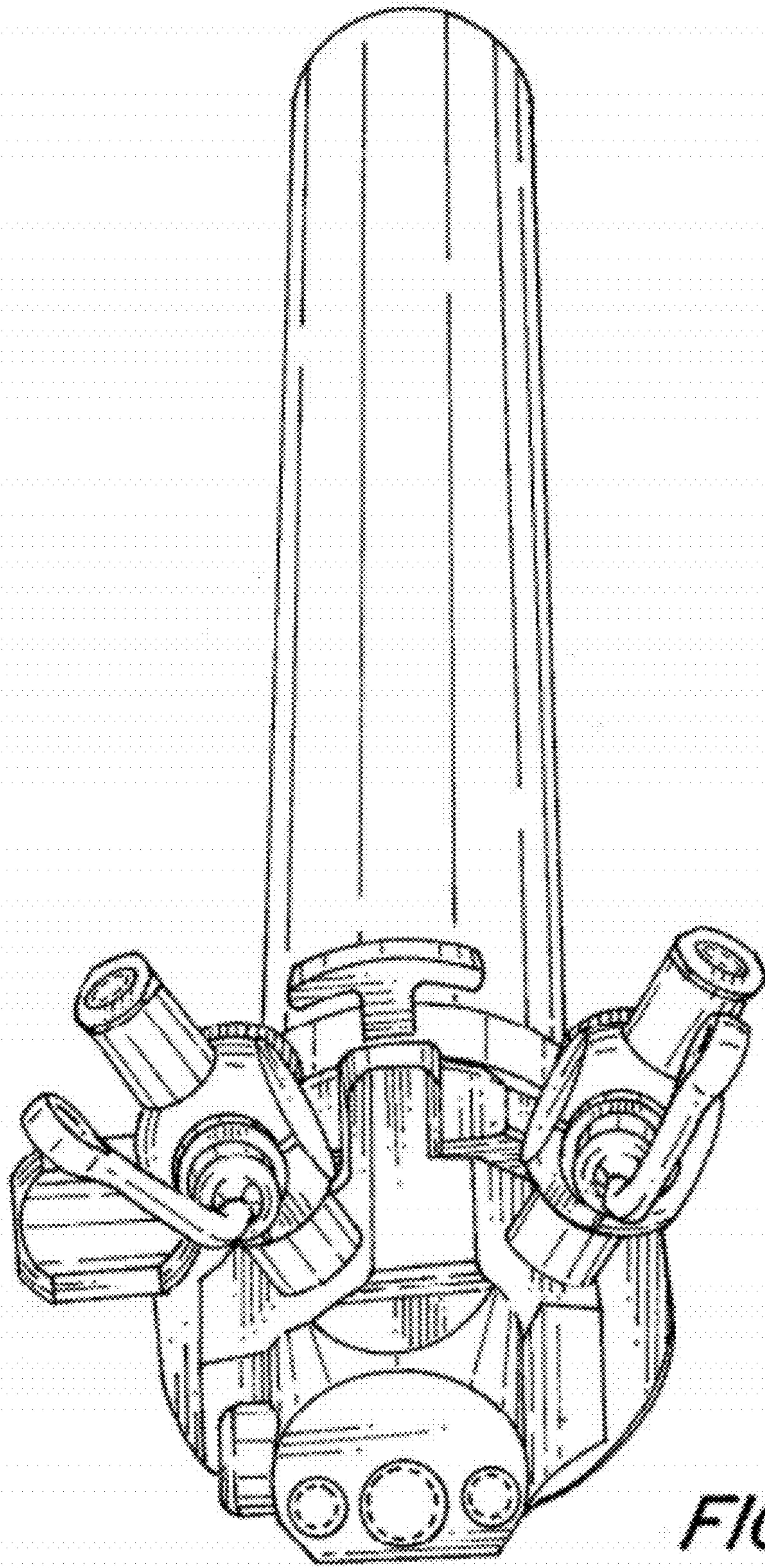

*FIG. 5*





*FIG. 6*



*FIG. 7*